

PRICE LIST 2025-01-01  
EUR excl. VAT

# HORR<sup>®</sup> EDS 1936



# HORREDS PRICE LIST EUR EXCL.VAT 2025-01-01

PRICE LIST 1: Office Furniture	
Fast delivery products	3-4
<b><u>A-FRAME</u></b>	
Desks	5-7
Screens and accessories	8
<b><u>NOMONO COMPACT</u></b>	
Nomono Compact	9-10
<b><u>NOMONO</u></b>	
Example arrangements	11-16
Nomono with gables	17-25
Nomono with T-legs	26-28
<b><u>SIGLO</u></b>	
Desks	29-32
Screens	33
<b><u>OTHER DESKS:</u></b>	
VX/Henry/Fri	34-38
Cable entrie Cable	39-40
VX8 / VX11 bordsstativ	41-42
<b><u>SCREENS</u></b>	
VX desk screen	45-46
A-Frame desk screen	8
<b><u>OFFICE STORAGE:</u></b>	
Storage with sliding doors, depth 43cm.	
Basic units	47-49
Extension units / trays	50
Bases	51-52
Sliding doors Biblio	53-55
Sliding doors Nomono	56-58
Sliding doors VX	59-61
Siglo	62-65
Storage with hinged doors, depth 43cm	66-67
Accessories storage	68
Personal storage	
VX personal storage	69-74
Side storage	
Biblio	75-76
Nomono A-side	77-78
Siglo	79-81
VX	82-83
Accessories	84

PRICE LIST 2: Meeting / Seating	
<b><u>MEETING TABLES:</u></b>	
VX Conference / VX Project / A-Frame	85-99
Nomono conference	100
Tin	101-102
Cable entries and accessories	103-106
<b><u>SEATING FURNITURE / VARIOUS:</u></b>	
Prime chair	107
Grand chair	108-111
Grand Balk	112-113
Glove chair	114-117
Glove Bolster Cover	118
Glove Lounge	119
Glove Bar stool	120
Cuba chair	121-122
Cuba chair with quilted upholstery	123-124
Base chair	125-128
VX Bar stool	129
VX Bar stool with castors	130
Log Armchair and Module sofa	131-134
Nomono Bench	135
Mute Focus	136-138
Mute Focus easy chair	139
Mute Floor	140-141
Mute sofa and easy chair	142
Exo Trolley	143
<b><u>SHELF SYSTEMS:</u></b>	
Parant	144-147
Anne	148-151
<b><u>COFFEE TABLES:</u></b>	
Lap	152
Log Laptop table	132

INFORMATION:	
Sales terms	153
Desk profiles	154
Material and colours	155-159
Price groups fabrics	160-162

Our digital price list is updated continuously.

Products may be added or expire and  
price adjustments may occur.

For the latest edition, see [www.horreds.se](http://www.horreds.se)





## Fast delivery products

### COMPLETE WORK PLACE IN 10 DAYS

### Good logistics solutions are the savior of some projects



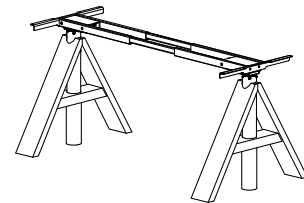
The products will be shipped from us within 10 business days.

We choose not to put any max volumes on this range but must reserve us for out-of-stock.

**A-Frame** desk tops are available in white HPL (19 mm MDF) and black linoleum (19 mm MDF) without cable lid.

A-Frame electric stand:

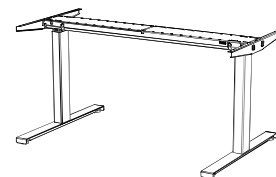
- Range 50 cm (table height 70-120 cm)
- Wooden A-legs in oak or ash with electric legs in white (RAL9016) or black (RAL9005)
- Flexible frame (black RAL9005)
- Lift capacity 160 kg, including table top, in widened weight.
- Power consumption in standby mode: 0,1 W
- PVC-free system
- PVC-fritt system



**VX** table tops are available in white alt. grey direct laminate (19 mm particle board), white high pressure laminate (19 mm MDF) and black linoleum (19 mm MDF). Comes with 2 cable entries including plastic cover in white or black.

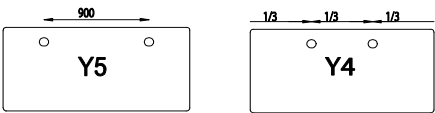
VX11 electric stand:

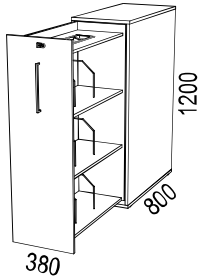
- Range 65 cm (table height 61-126 cm)
- Colours: white (RAL9016) / black (RAL9005)
- Flexible frame 1156-1756 mm (svart RAL9005)
- Lift capacity 160 kg, including table top, in widened weight.
- Power consumption in standby mode: 0,1 W
- PVC-free system
- With built-in anti-collision function (DS1)



For additional product information: please see [www.horreds.se](http://www.horreds.se)

Desk tops A-Frame	Artikelnr	White HPL (31)	Black linoleum (88)
A-Frame table top 1600x800 mm	64xx1607550V	477	652
A-Frame table top 1400x800 mm	64xx1607742V	477	652
Electric stand A-frame	Artikelnr	Vit (31)	Svart (37)
Electr. legs, range 50 (70-120 cm) with wooden A-legs in oak	64xx31250-2	1 654	1 654

Desk tops VX	Artikelnr	White direct laminate (31S)	Light grey dir.lam. (61S)	Vit HPL laminate (31)	Black linoleum (88)
VX table top 1600x800 mm with 2 st cable holes plac Y5	34xx481-07061	194	261		
VX table top 1400x800 mm with 2 st cable holes plac Y5	34xx481-07297	194	261		
VX table top 1200x800 mm with 2 st cable holes plac Y4	34xx481-07298	182	234		
VX table top 1600x800 mm with 2 st cable holes plac Y5	34xx167025K			446	609
VX table top 1400x800 mm with 2 st cable holes plac Y5	34xx167024K			446	609
VX table top 1200x800 mm with 2 st cable holes plac Y4	34xx167023K			446	609
					
Electric stand VX11	Article nr	White (31)	Black (37)		
VX 11 range 65 cm	VX11xx657-1	549	549		
Accessories	Article no	White (31)	Black (37)		
Cable tray 1100 mm (for table tops 1600 och 1400 mm)	29xx140	102	102		
Cable tray 800 mm (for table tops 1200 mm)	29xx142	102	102		

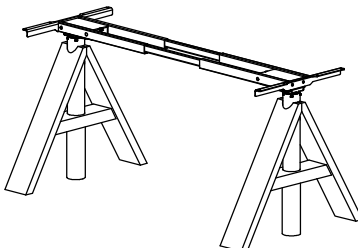
Side storage	Article nr	White
<p>Choose colour of handle: white, black or stainless steel look</p>  <p>VX side storage 380x1200x800 mm. White dir.laminate, incl pen holder and brackets. Left or right. (Illustration shows left)</p>	343121B	1 077



**A-Frame** Design: Anderssen & Voll**A-FRAME**

- A-Frame desk tops are made of 19 mm MDF with straight edge.
  - Radius 0.
  - Shape rectangular
  - Cable lid in same material as table top as option. Placed on left side as standard. om inget annat anges vid beställningstillfället.
  - **High Pressure laminate:**

White HPL (lam 0754)	Closest NCS: S0502-Y
Light grey HPL (optional lam 0419)	S2002-Y
Light grey HPL (optional lam 1365)	S2005-R80B
Medium grey HPL (opt. lam. 1023)	S5500-N
Anthracite HPL (opt. lam. 1397)	S7500-N
Black HPL (optional lam 2253)	S9000-N
  - **Linoleum from Forbo Flooring:**

4132 Ash	5502-G
4154 Burgundy	7010-R10B
4166 Charcoal	8502-B
4172 Mauve	7005-Y80R
4174 Conifer	8010-B90G
4175 Pebble	3502-Y
4176 Mushroom	2002-Y
4177 Vapour	2005-G10Y
4179 Smokey Blue	7010-R90B
4184 Olive	5010-G50Y
  - **Veneer group 1:**
    - Oak nature (03)
    - Ash nature (06)
  - **Veneer group 2:**
    - White pigmented oak (30)
    - White pigmented ash (10)
    - Black stained ash (86)
    - Dark stained ash (76)
    - Burgundy stained ash (C8)
    - Conifer stained ash (D3)
    - Smokey Blue stained ash (D4)
- 
- Electric stand, range 50 cm (desk height 70-120 cm). Electric legs in white (RAL 9016) or black (RAL 9005), with solid wooden A-legs in oak or ash.
  - Fixed stand, desk height 73 cm. Metal leg in white or black with solid wooden A-legs in oak or ash.
  - Brackets information is referring to the desk height (incl the table top)
  - Horreds height adjustment control (touchpad) milled in desk top as option.
  - For additional product information please see [www.horreds.se](http://www.horreds.se)

**A-Frame** Design: Anderssen & Voll

**B**

Desks within size 2000x900 mm

Note: Separate prices top tops and stands.

Select first the table top, then add price for stand and options.

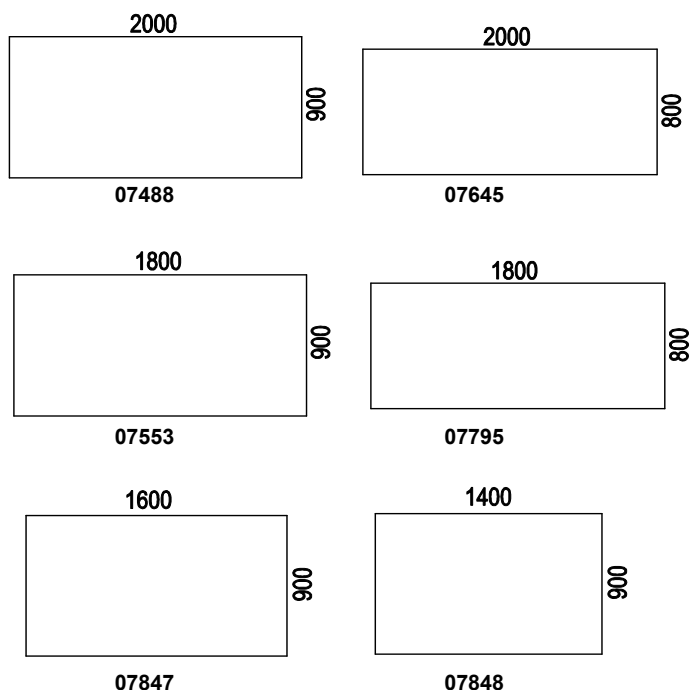
The table's drawing number is listed under the table symbol.

Desk top	Article no	White HPL (31)	Optional HPL (39)	Linoleum (88)	Veneer group 1	Veneer Group 2
A-Frame desk top in B-format	64xx16xxxxB	516	633	752	522	522

Stands	Article no	Solid wood A-legs with white legs	Solid wood A-legs with black legs
Electric stand range 50 cm (70-120) with solid A-legs in oak or ash (nature/stained/white pigmented)	64xx31250-x 64xx37250-x	1 654	1 654
Fixed stand (desk height 73 cm) with solid A-legs in oak or ash (nature/stained/white pigmented)	64xx31200-x 64xx37200-x	985	985

Options:		Upcharge:
Cable lid	64xx07438	152
Horreds touch pad	343707444	55
Veneered edge on laminate table		104
Veneered edge on linoleum table*		104

\* only oak/ash nature + white pigmented (not stained).



**A-Frame** Design: Anderssen & Voll

**E** Desks within size 1600x800 mm

Note: Separate prices top tops and stands.

Select first the table top, then add price for stand and options.  
The table's drawing number is listed under the table symbol.

Desk top	Article no	White HPL (31)	Optional HPL (39)	Linoleum (88)	Veneer group 1	Veneer Group 2
A-Frame desk top in E-format	64xx16xxxxE	477	534	652	497	497

Stands	Article no	Solid wood A-legs with white legs	Solid wood A-legs with black legs
Electric stand range 50 cm (70-120) with solid A-legs in oak or ash (nature/stained/white pigmented)	64xx31250-x 64xx37250-x	1 654	1 654
Fixed stand (desk height 73 cm) with solid A-legs in oak or ash (nature/stained/white pigmented)	64xx31200-x 64xx37200-x	985	985

Options:		Upcharge:
Cable lid	64xx07438	152
Horreds touch pad	343707444	55
Veneered edge on laminate table		104
Veneered edge on linoleum table*		104

\* only oak/ash nature + white pigmented (not stained).

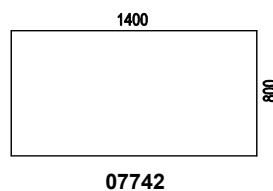
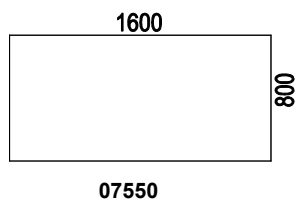





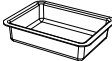





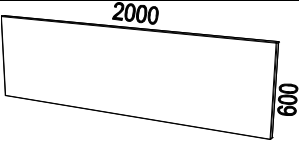
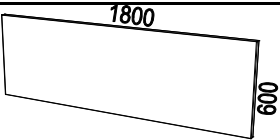
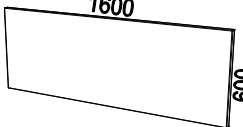
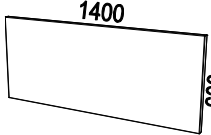

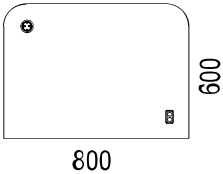
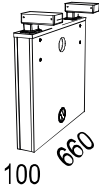
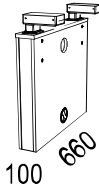
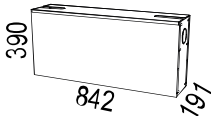
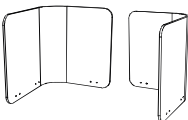
Illustration	Description	Article number	Material	EUR	
<b>A-Frame</b> Design: Anderssen & Voll					
<b>A-Frame ACCESSORIES</b>		<b>RAL colours:</b> <b>31 White</b> RAL 9016 str <b>37 Black</b> RAL 9005 str			
	Cable entry including lid 250x150 mm in same material as the desk top. Note: no matching of veneer.	64 31 <b>07438</b> 64 xx <b>07438</b> 64 xx <b>07438</b> 64 xx <b>07438</b> 64 xx <b>07438</b>	White HPL Optional HPL Linoleum Oak / ash Stained/pigm.	152 152 152 152 152	
	Cable tray in felt 300x220x80 mm	64 98 <b>07403-1</b>	Anthracite	75	
	Shelf in wood , ø 250 mm, höjd 150 mm	64 03 <b>08990</b> 64 D5 <b>08990</b> 64 xx <b>08990</b>	Oak Hard vax oiled oak Veneer gr 2	266 266 266	
	Shelf in wood, ø 250 mm, incl metal bracket in black or white	64 xxxx <b>08992</b> 64 xxxx <b>08992</b>	Hard vax oiled oak Veneer gr 2	257 257	
	Shelf in metal, ø 250 mm, höjd 135 mm	64 31 <b>07430</b> 64 37 <b>07430</b>	White Black	266 266	
	Shelf in metall, ø 250 mm, incl.bracket	64 31 <b>07429</b> 64 37 <b>07429</b>	White Black	257 257	
	3-way power outlet, with bracket	34 37 <b>07434</b>	Black	97	
<b>A-frame SOUND ABSORBING DESK SCREEN</b> • For mounting in desk top • Thickness approx. 35 mm, of which 30 mm sound absorber • Height over desk: 500 mm • Brackets to be ordered separately • For fabric codes: please see the supplier's website					
<b>Price group 1:</b> <u>Camira:</u> Cara, Carlow <u>Gabriel:</u> Event Screen, Hush		<b>Price group 2:</b> <u>Camira:</u> Blazer Lite <u>Gabriel:</u> Soul, Soul Mel., Twist, Twist Mel. <b>Focus Melange Screen, Cura Screen</b> <u>Kvadrat:</u> Hint		<b>Price group 3:</b> <u>Camira:</u> Blazer, Main Line Flax <u>Gabriel:</u> Step Melange Screen <u>Kvadrat:</u> Remix, Remix Screen, Floyd Screen	
	Sound absorbing desk screen, excluding brackets, length 2000 mm	64 97 <b>82000-x</b>	PG 1 PG 2 PG 3	541 629 700	
	Brackets	34 37 <b>06794-4</b>	svart	93	
	Sound absorbing desk screen, excluding brackets, length 1800 mm	64 97 <b>81800-x</b>	PG 1 PG 2 PG 3	479 559 623	
	Brackets	34 37 <b>06794-4</b>	svart	93	
	Sound absorbing desk screen, excluding brackets, length 1600 mm	64 97 <b>81600-x</b>	PG 1 PG 2 PG 3	453 525 582	
	Brackets	34 37 <b>06794-4</b>	svart	93	
	Sound absorbing desk screen, excluding brackets, length 1400 mm	64 97 <b>81400-x</b>	PG 1 PG 2 PG 3	409 465 534	
	Brackets	34 37 <b>06794-4</b>	svart	93	

Illustration	Description	Articel number	Material	EUR
<b>Nomono Compact Design: Fredrik Mattson</b>				
 <p><b>Nomono Compact DESK SYSTEM</b></p> <ul style="list-style-type: none"> <li>• Nomono Compact table top is made of 19mm MDF with matching edging.</li> <li>• Electrically adjustable table height 70-120cm.</li> <li>• Choose the colour of the electric legs and visible steel and plastic details on legs boxes; black or white.</li> <li>• Deskscreen in moulded felt; anthrazite or upholstered.</li> <li>• For more product information <a href="http://www.horreds.se">www.horreds.se</a></li> </ul> <p><u>Veneer gr 1:</u> Oak (03), Ash (06).  <u>Veneer gr 2:</u> White pigm. oak (30), White pigm.ash (10), Black stained ash (86), Dark stained ash (76), Burgundy stained ash (C8), Conifer stained ash (D3), Smokey blue stained ash (D4).  <u>White HPL:</u> Closest NCS S0502-Y (31)  <u>Optional HPL:</u> Light grey 0419 (2A), light grey 1365 (2B), medium grey 1023 (2C), anthracite 1397 (2D), black F2253 (2E)  <u>Linoleum:</u> 4132 Ash (1B), 4154 Burgundy (1C), 4166 Charcoal (1G), 4172 Mauve (1U), 4174 Conifer (1H), 4175 Pebble (1I), 4176 Mushroom (1J), 4177 Vapour (1K), 4179 Smokey Blue (1M), 4184 Olive (1R).</p>				
	Desk top 800x600mm R100 rear corner. Including 1 black Powerdot (PM50) and black moulded hand control.	53 xxz <b>09254H</b>	White HPL Optional HPL Linoleum Veneer gr 1 Veneer gr 2	534 583 766 672 672
	Leg box / outer gable 660x610x100mm Incl.electric legs, black or white	53 xxz <b>09255</b>	White dir.lam. Veneer gr 1 Veneer gr 2	933 1 154 1 154
	Leg box / centre gable 660x610x100mm Incl.electric legs, black or white.	53 xxz <b>09292</b>	White dir.lam. Veneer gr 1 Veneer gr 2	933 1 154 1 154
	Cable tray 842x390x191mm including 2 x 6way power sockets.  Metal cover for cable tray.	53 xxz <b>09260</b>  53 37 <b>09274</b> 53 31 <b>09274</b>	White dir.lam. Veneer gr 1 Veneer gr 2  Black White	585 659 659  79 79
	Desk screen 2 pieces (5309324H+5309324V) including 2 sets of fittings (2x533709312-3), black.		Felt anthrazite Camira Blazer Cami. Blazer Lite Camira Synergy Kvadrat Hero Kv. Hero Heather	493 716 716 776 896 896
	Cable sock ø 20mm in braied textile.  Length 1500 mm. With zipper.	32 54 <b>000109</b> 32 54 <b>000101</b>	Black  White	39  39

**PRICE EXAMPLE**

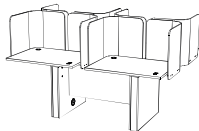
• Below prices are based on white laminate/white direct laminate and screen in moulded felt.

**A. 4-group without screens**



Table top 800x600mm	53 xxy <b>09254H</b>	4	534	2 136
Leg box / outer gable 660x610x100mm	53 xxy <b>09255</b>	2	933	1 866
Cable tray 842x390x191	53 xxz <b>09260</b>	1	585	585
Cover for cable tray	53 xx <b>09274</b>	1	79	79
<b>Totalt</b>				<b>4 666</b>

**B. 4-grupp with screens**



Like A above		1	4666	4 666
Screen left, grey moulded felt	53 <b>09324V-xxx</b>	4	175	700
Screen right, grey moulded felt	53 <b>09324H-xxx</b>	4	175	700
Screen fittings	53 37 <b>09312-3</b>	8	71	568
<b>Totalt</b>				<b>6 634</b>

**C. 6-group without screens**

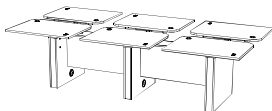
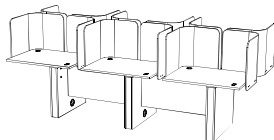


Table top 800x600mm	53 xxy <b>09254H</b>	6	534	3 204
Leg box / outer gable 660x610x100mm	53 xxy <b>09255</b>	2	933	1 866
Leg box / centre gable 660x610x100mm	53 xxy <b>09292</b>	1	933	933
Cable tray 842x390x191	53 xxy <b>09260</b>	2	585	1 170
Cover for cable tray	53 xx <b>09274</b>	2	79	158
<b>Totalt</b>				<b>7 331</b>

**D. 6-group with screens**



Like C above		1	7331	7 331
Screen left, grey moulded felt	53 <b>09324V-xxx</b>	6	175	1 050
Screen right, grey moulded felt	53 <b>09324H-xxx</b>	6	175	1 050
Screen fittings	53 37 <b>09312-3</b>	12	71	852
<b>Totalt</b>				<b>10 283</b>

**E. 8-group without screens**

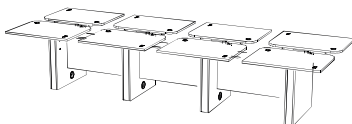
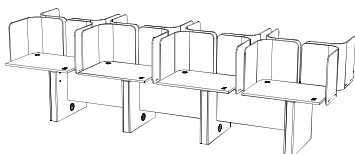


Table top 800x600mm	53 xxy <b>09254H</b>	8	534	4 272
Leg box / outer gable 660x610x100mm	53 xxy <b>09255</b>	2	933	1 866
Leg box / centre gable 660x610x100mm	53 xxy <b>09292</b>	2	933	1 866
Cable tray 842x390x191	53 xxy <b>09260</b>	3	585	1 755
Cover for cable tray	53 xx <b>09274</b>	3	79	237
<b>Totalt</b>				<b>9 996</b>

**F. 8-group with screens**



Like E above		1	9996	9 996
Screen left, grey moulded felt	53 <b>09324V-xxx</b>	8	175	1 400
Screen right, grey moulded felt	53 <b>09324H-xxx</b>	8	175	1 400
Screen fittings	53 37 <b>09312-3</b>	16	71	1 136
<b>Totalt</b>				<b>13 932</b>



# Nomono



NOMONO is specially designed to work in open plan offices.

Its clear and firm horizontal tables calms down an environment can sometimes be perceived as a bit chaotic with the desktop screens at different altitudes. The legs have covered sides to further tidy up the office.

In Nomono there are integrated cable boxes that hide the cable clutter that usually occurs in an office. The box is handy for laptop, ipod or phone charger. It can also be equipped with a USB or other technology that connects the office.

Nomono has also another type of leg, a more classic height-adjustable leg, we call it Nomono T. Everything to make it possible to use Nomono in all kinds of environments and offices.

It is important that the workplace may look different. You can choose the accessories you want and color after taste or to suit the corporate image.

Nomono is truly worked out in every detail. A reliable, highly competent and attractive fellow worker.

Design: Fredrik Mattson

5520

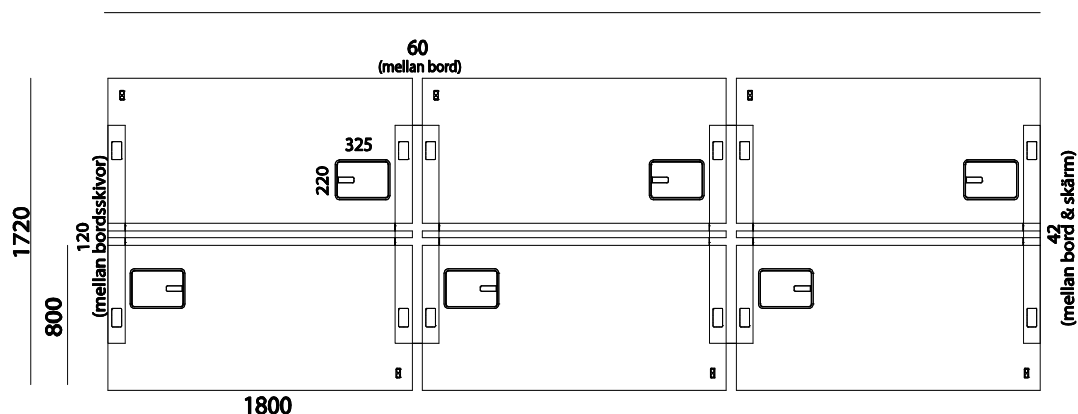


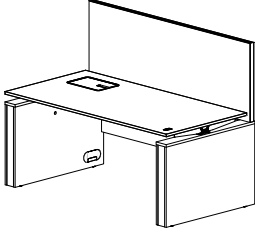
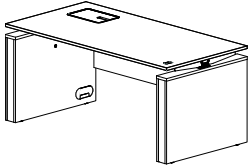
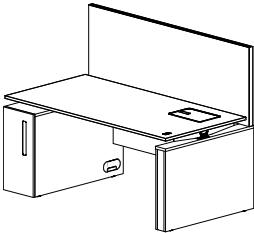
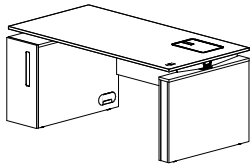
Illustration	Description	Article number	Pcs	Price/ piece	EUR
<b>Nomono Design: Fredrik Mattson</b>					
<b>Nomono ARRANGEMENTS</b>					
<p>• We have in the examples below made use of desk tops 1800x800 mm in white laminate. If you choose a different size of desk top, please make sure to adjust to correct size of desk screen, cable etc as well.</p>					
<b>A. <u>Single desk</u></b>					
	Desk top 1800x800	53 31 <b>5303SEK</b>	1	1002	1 002
	Gable 880x100 mm	53 31 <b>W2500V/H</b>	2	1085	2 170
	Desk screen, fabric in price group 1	34 97 <b>06632-x</b>	1	437	437
	Screen brackets	53 37 <b>01069</b>	1	126	126
	Cable box	53 31 <b>5300xx</b>	1	293	293
	Front panel	53 31 <b>80184</b>	1	264	264
	Cable tray	53 31 <b>03790-2</b>	1	237	237
	<b>Total</b>				
<b>B. <u>Single desk</u></b>					
	Desk top 1800x800	53 31 <b>5303SEK</b>	1	1002	1 002
	Gable 800x100 mm	53 31 <b>W02445V/H</b>	2	1027	2 054
	Cable box	53 31 <b>5300xx</b>	1	293	293
	Front panel	53 31 <b>80184</b>	1	264	264
	Cable tray	53 31 <b>03790-2</b>	1	237	237
	<b>Total</b>				
<b>C. <u>Singelplats med boxförvaring</u></b>					
	Desk top 1800x800	53 31 <b>5322SEK</b>	1	1002	1 002
	Gable 880x100 mm, right	53 31 <b>W02500H</b>	1	1085	1 085
	Gable 880x300 with storage, left	53 31xx <b>W02505V</b>	1	1496	1 496
	Desk screen, fabric in price group 1	34 97 <b>06632-x</b>	1	437	437
	Screen brackets	53 37 <b>01069</b>	1	126	126
	Cable box	53 31 <b>5300xx</b>	1	293	293
	Cable tray	53 31 <b>03790-2</b>	1	237	237
	<b>Total</b>				
<b>D. <u>Single desk with storage</u></b>					
	Desk top 1800x800	53 31 <b>5322SEK</b>	1	1002	1 002
	Gable 800x100 mm, right	53 31 <b>W02445H</b>	1	1027	1 027
	Gable 800x300 with storage, left	53 31xx <b>W02450V</b>	1	1437	1 437
	Cable box	53 31 <b>5300xx</b>	1	293	293
	Cable tray	53 31 <b>03790-2</b>	1	237	237
	<b>Total</b>				

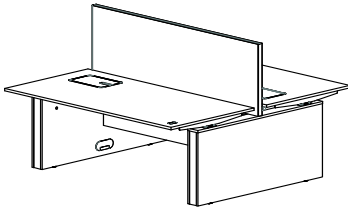
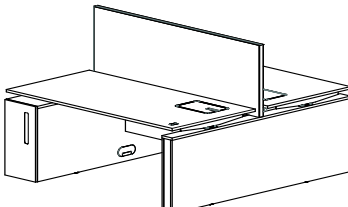
Illustration	Description	Article number	Pcs	Price/ piece	EUR
<b>E. 2-group</b>					
					
	Desk top 1800x800	53 31 <b>5303SEK</b>	2	1002	2 004
	Gable 1200x100 mm	53 31 <b>W02460</b>	2	1525	3 050
	Desk screen, fabric in price group 1	34 97 <b>06632-x</b>	1	437	437
	Screen brackets	53 37 <b>01069</b>	1	126	126
	Cable tray	53 31 <b>03790-4</b>	1	283	283
	Cable box	53 31 <b>5300xx</b>	2	293	586
	Mittpanel	53 31 <b>02490-3</b>	1	169	169
	<b>Total</b>				<b>6 655</b>
<b>F. 2-group with storage</b>					
					
	Desktop 1800x800	53 31 <b>5303SEK</b>	1	1002	1 002
	Desktop 1800x800	53 31 <b>5322SEK</b>	1	1002	1 002
	Gable 1720x100 mm	53 31 <b>W02470</b>	1	1555	1 555
	Gable 1720x300 mm with storage	53 31xx <b>W02485</b>	1	2230	2 230
	Desk screen, fabric in price group 1	34 97 <b>06632-x</b>	1	437	437
	Screen brackets	53 37 <b>01069</b>	1	126	126
	Cable tray	53 31 <b>03790-4</b>	1	283	283
	Cable box	53 31 <b>5300xx</b>	2	293	586
	<b>Total</b>				<b>7 221</b>



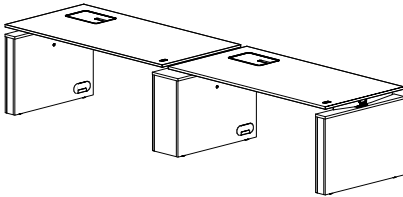
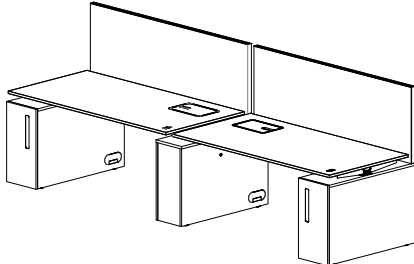
Illustration	Description	Article number	Pcs	Price/ piece	EUR
<b>G1. <u>2-group side by side</u></b>					
					
	Desk top 1800x800	53 31 <b>5303SEK</b>	2	1002	2 004
	Gable 800x100 mm	53 31 <b>W02445V/H</b>	2	1027	2 054
	Gable 800x260 mm	53 31 <b>W02455</b>	1	1525	1 525
	Cable box	53 31 <b>5300xx</b>	2	293	586
	Cable tray	53 31 <b>03790-2</b>	2	237	474
	<b>Total</b>				<b>6 643</b>
<b>G2. <u>2-group side by side with storage</u></b>					
					
	Desk top 1800x800	53 31 <b>5303SEK</b>	1	1002	1 002
	Desk top 1800x800	53 31 <b>5322SEK</b>	1	1002	1 002
	Gable 880x300 with storage	53 31 <b>W02505V/H</b>	2	1496	2 992
	Gable 880x260 mm	53 31 <b>W03075</b>	1	1584	1 584
	Desk screen, fabric in price group 1	34 97 <b>06632-x</b>	2	437	874
	Screen brackets	53 37 <b>01069</b>	2	126	252
	Cable box	53 31 <b>5300xx</b>	2	293	586
	Cable tray	53 31 <b>03790-2</b>	2	237	474
	<b>Total</b>				<b>8 766</b>

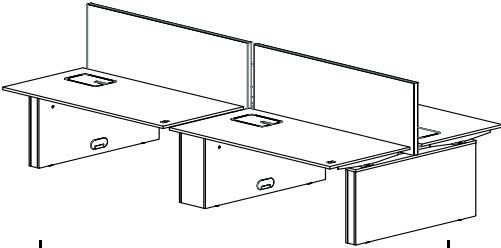
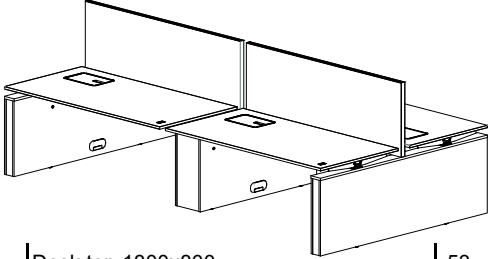
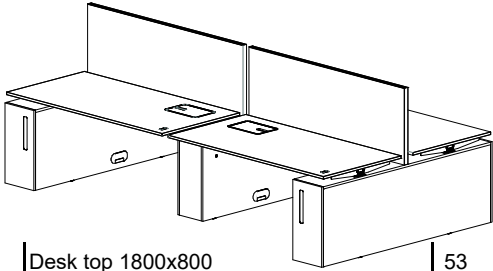
Illustration	Description	Article number	Pcs	Price/ piece	EUR
<b>H. 4-group (with gables 1200 mm)</b>					
					
	Desk top 1800x800	53 31 5303SEK	4	1002	4 008
	Gable 1200x100 mm	53 31 W02460	2	1525	3 050
	Gable 1200x260 mm	53 31 W02465	1	2318	2 318
	Desk screen, fabric in price group 1	34 97 06632-x	2	437	874
	Screen brackets	53 37 01069	2	126	252
	Cable tray	53 31 03790-4	2	283	566
	Cable box	53 31 5300xx	4	293	1 172
	<b>Total</b>				<b>12 240</b>
<b>I. 4-group (with outer gables 1720 mm)</b>					
					
	Desk top 1800x800	53 31 5303SEK	4	1002	4 008
	Gable 1720x100	53 31 W02470	2	1555	3 110
	Gable 1200x260 mm	53 31 W02465	1	2318	2 318
	Desk screen, fabric in price group 1	34 97 06632-x	2	437	874
	Screen brackets	53 37 01069	2	126	252
	Cable tray	53 31 03790-4	2	283	566
	Cable box	53 31 5300xx	4	293	1 172
	<b>Total</b>				<b>12 300</b>
<b>J. 4-grup with storage</b>					
					
	Desk top 1800x800	53 31 5303SEK	2	1002	2 004
	Desk top 1800x800	53 31 5322SEK	2	1002	2 004
	Gable 1720x300 with storage	53 31xx W02485	2	2230	4 460
	Gable 1200x260	53 31 W02465	1	2318	2 318
	Desk screen, fabric in price group 1	34 97 06632-x	2	437	874
	Screen brackets	53 37 01069	2	126	252
	Cable tray	53 31 03790-4	2	283	566
	Cable box	53 31 5300xx	4	293	1 172
	<b>Total</b>				<b>13 650</b>

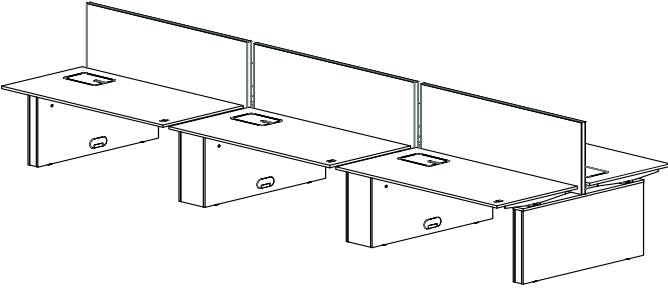
Illustration	Description	Article number	Pcs	Price/ piece	EUR
<b>K. 6-group</b>					
					
	Desk top 1800x800	53 31 <b>5303SEK</b>	6	1002	6 012
	Gable 1200x100 mm	53 31 <b>W02460</b>	2	1525	3 050
	Gable 1200x260 mm	53 31 <b>W02465</b>	2	2318	4 636
	Desk screen, fabric in price group 1	34 97 <b>06632-x</b>	3	437	1 311
	Screen brackets	53 37 <b>01069</b>	3	126	378
	Cable tray	53 31 <b>03790-4</b>	3	283	849
	Cable box	53 31 <b>5300xx</b>	6	293	1 758
	<b>Total</b>				<b><u>17 994</u></b>





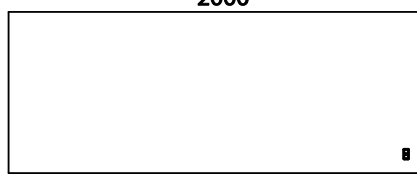
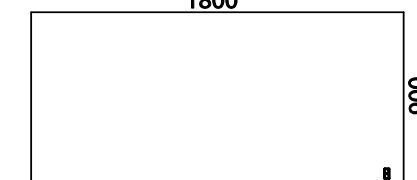
Illustration	Description	Article number	Material	EUR		
<p><b>Nomono</b> Design: Fredrik Mattson </p>						
<p><b>Nomono</b> DESK TOPS</p> <ul style="list-style-type: none"> <li>Nomono desk tops are made of 19 mm MDF. Radius 0.</li> <li>Gables not included in below prices. Order separately.</li> <li>Price for cable lid is not included in below prices. Order separately.</li> <li>For additional product information: please see <a href="http://www.horreds.se">www.horreds.se</a></li> </ul> <p><u>White HPL:</u> closest NCS S0502-Y  <u>Optional HPL:</u> Light grey, medium grey, anthracite and black.  <u>Linoleum:</u> 4132 Ash, 4154 Burgundy, 4166 Charcoal, 4172 Mauve, 4174 Conifer, 4175 Pebble, 4176 Mushroom, 4177 Vapour, 4179 Smokey Blue, 4184 Olive.  <u>Veneer group 1:</u> Oak (03) / Ash (06)  <u>Veneer group 2:</u> White pigmented Oak (30), White pigmented Ash (10), Black stained Ash (86), Dark stained Ash (76), Burgundy stained ash (C8), Conifer stained ash (D3), Smokey Blue stained ash (D4).</p>						
	Desk top 2000x900 mm. Including touchpad, frame and trafo. Prepared for cable box <b>left</b> side	53 31 <b>5306SEK</b> 53 xx <b>5306SEK</b> 53 xx <b>5306SEK</b> 53 xx <b>5306SEK</b> 53 xx <b>5306SEK</b>	White HPL Optional HPL Linoleum Veneer group 1 Veneer group 2	1 002 1 116 1 201 1 008 1 008		
	Desk top 2000x900 mm. Including touchpad, frame and trafo. Prepared for cable box <b>right</b> side	53 31 <b>5321SEK</b> 53 xx <b>5321SEK</b> 53 xx <b>5321SEK</b> 53 xx <b>5321SEK</b> 53 xx <b>5321SEK</b>	White HPL Optional HPL Linoleum Veneer group 1 Veneer group 2	1 002 1 116 1 201 1 008 1 008		
		Desk top 2000x800 mm. Including touchpad, frame and trafo. Prepared for cable box <b>left</b> side	53 31 <b>5305SEK</b> 53 xx <b>5305SEK</b> 53 xx <b>5305SEK</b> 53 xx <b>5305SEK</b>	White HPL Optional HPL Linoleum Veneer group 1 Veneer group 2	1 002 1 116 1 201 1 008 1 008	
		Desk top 2000x800 mm. Including touchpad, frame and trafo. Prepared for cable box <b>right</b> side	53 31 <b>5324SEK</b> 53 xx <b>5324SEK</b> 53 xx <b>5324SEK</b> 53 xx <b>5324SEK</b> 53 xx <b>5324SEK</b>	White HPL Optional HPL Linoleum Veneer group 1 Veneer group 2	1 002 1 116 1 201 1 008 1 008	
			Desk top 1800x900 mm. Including touchpad, frame and trafo. Prepared for cable box <b>left</b> side	53 31 <b>5304SEK</b> 53 xx <b>5304SEK</b> 53 xx <b>5304SEK</b> 53 xx <b>5304SEK</b> 53 xx <b>5304SEK</b>	White HPL Optional HPL Linoleum Veneer group 1 Veneer group 2	1 002 1 116 1 201 1 008 1 008
			Desk top 1800x900 mm. Including touchpad, frame and trafo. Prepared for cable box <b>right</b> side	53 31 <b>5318SEK</b> 53 xx <b>5318SEK</b> 53 xx <b>5318SEK</b> 53 xx <b>5318SEK</b> 53 xx <b>5318SEK</b>	White HPL Optional HPL Linoleum Veneer group 1 Veneer group 2	1 002 1 116 1 201 1 008 1 008





Illustration	Description	Article number	Material	EUR
	Desk top 1800x800 mm.	53 31 <b>5303SEK</b>	White HPL	1 002
	Including touchpad, frame and trafo.	53 xx <b>5303SEK</b>	Optional HPL	1 116
	Prepared for cable box <b>left</b> side	53 xx <b>5303SEK</b>	Linoleum	1 201
		53 xx <b>5303SEK</b>	Veneer group 1	1 008
		53 xx <b>5303SEK</b>	Veneer group 2	1 008
	Desk top 1800x800 mm.	53 31 <b>5322SEK</b>	White HPL	1 002
	Including touchpad, frame and trafo.	53 xx <b>5322SEK</b>	Optional HPL	1 116
	Prepared for cable box <b>right</b> side	53 xx <b>5322SEK</b>	Linoleum	1 201
		53 xx <b>5322SEK</b>	Veneer group 1	1 008
		53 xx <b>5322SEK</b>	Veneer group 2	1 008
	Desk top 1600x900 mm.	53 31 <b>5302SEK</b>	White HPL	1 002
	Including touchpad, frame and trafo.	53 xx <b>5302SEK</b>	Optional HPL	1 116
	Prepared for cable box <b>left</b> side	53 xx <b>5302SEK</b>	Linoleum	1 201
		53 xx <b>5302SEK</b>	Veneer group 1	1 008
		53 xx <b>5302SEK</b>	Veneer group 2	1 008
	Desk top 1600x900 mm.	53 31 <b>5320SEK</b>	White HPL	1 002
	Including touchpad, frame and trafo.	53 xx <b>5320SEK</b>	Optional HPL	1 116
	Prepared for cable box <b>right</b> side	53 xx <b>5320SEK</b>	Linoleum	1 201
		53 xx <b>5320SEK</b>	Veneer group 1	1 008
		53 xx <b>5320SEK</b>	Veneer group 2	1 008
	Desk top 1600x800 mm.	53 31 <b>5301SEK</b>	White HPL	964
	Including touchpad, frame and trafo.	53 xx <b>5301SEK</b>	Optional HPL	1 000
	Prepared for cable box <b>left</b> side	53 xx <b>5301SEK</b>	Linoleum	1 131
		53 xx <b>5301SEK</b>	Veneer group 1	983
		53 xx <b>5301SEK</b>	Veneer group 2	983
	Desk top 1600x800 mm.	53 31 <b>5323SEK</b>	White HPL	964
	Including touchpad, frame and trafo.	53 xx <b>5323SEK</b>	Optional HPL	1 000
	Prepared for cable box <b>right</b> side	53 xx <b>5323SEK</b>	Linoleum	1 131
		53 xx <b>5323SEK</b>	Veneer group 1	983
		53 xx <b>5323SEK</b>	Veneer group 2	983
	Desk top 1400x900 mm.	53 31 <b>5311SEK</b>	White HPL	964
	Including touchpad, frame and trafo.	53 xx <b>5311SEK</b>	Optional HPL	1 000
	Prepared for cable box <b>left</b> side	53 xx <b>5311SEK</b>	Linoleum	1 131
		53 xx <b>5311SEK</b>	Veneer group 1	983
		53 xx <b>5311SEK</b>	Veneer group 2	983
	Desk top 1400x900 mm.	53 31 <b>5339SEK</b>	White HPL	964
	Including touchpad, frame and trafo.	53 xx <b>5339SEK</b>	Optional HPL	1 000
	Prepared for cable box <b>right</b> side	53 xx <b>5339SEK</b>	Linoleum	1 131
		53 xx <b>5339SEK</b>	Veneer group 1	983
		53 xx <b>5339SEK</b>	Veneer group 2	983

Illustration	Description	Article number	Material	EUR	
	Desk top 1400x800 mm. Including touchpad, frame and trafo. Prepared for cable box <b>left</b> side	53 31 <b>5312SEK</b> 53 xx <b>5312SEK</b> 53 xx <b>5312SEK</b> 53 xx <b>5312SEK</b> 53 xx <b>5312SEK</b>	White HPL Optional HPL Linoleum Veneer group 1 Veneer group 2	964 1 000 1 131 983 983	
	Desk top 1400x800 mm. Including touchpad, frame and trafo. Prepared for cable box <b>right</b> side	53 31 <b>5338SEK</b> 53 xx <b>5338SEK</b> 53 xx <b>5338SEK</b> 53 xx <b>5338SEK</b> 53 xx <b>5338SEK</b>	White HPL Optional HPL Linoleum Veneer group 1 Veneer group 2	964 1 000 1 131 983 983	
	<b>Nomono GABLES</b>				
	<b>Color handles / closest NCS:</b>				
	31 White S 0300-N				
	37 Black S 9000-N				
	32 Yellow S 1070-Y				
	36 Green S 2570-G30Y				
	33 Red S 1580-Y80R				
	35 Turquoise S0540-B30G				
42 Orange S 1080-Y50R					
<ul style="list-style-type: none"> <li>• Including electrical legs, adjustable 73-120 cm</li> <li>• Height from floor to top of gable: 618 mm</li> </ul>					
<p><u>Veneer group 1:</u> Oak (03) / Ash (06)</p> <p><u>Veneer group 2:</u> white oak (30), black ash (86), white ash (10), dark ash (76) Burgundy st. ash(C8) Conifer st.ash (D3), Smokey Blue st.ash (D4).</p>					
Options:					
<ul style="list-style-type: none"> <li>• Gable door with lock: additional € 65 / door</li> <li>• Cable hole outer side of gable: additional € 92 / gable</li> <li>• Handles in Elmosoft 54035 Light Brown € 35:- / handle</li> </ul>					
<b>Depth 800 mm - for single desk <u>without</u> desk screen</b>					
	Gable 800x100, left	53 31W <b>02445V</b> 53 xxX <b>02445V</b> 53 xxX <b>02445V</b>	White dir.laminate Veneer group 1 Veneer group 2	1 027 1 467 1 467	
	Gable 800x100, right	53 31W <b>02445H</b> 53 xxX <b>02445H</b> 53 xxX <b>02445H</b>	White dir.laminate Veneer group 1 Veneer group 2	1 027 1 467 1 467	
	Gable 800x300 mm, left, with storage	53 31Wxx <b>02450V</b> 53 xxXxx <b>02450V</b> 53 xxXxx <b>02450V</b>	White dir.laminate Veneer group 1 Veneer group 2	1 437 2 288 2 288	
	Gable 800x300 mm, right, with storage	53 31Wxx <b>02450H</b> 53 xxXxx <b>02450H</b> 53 xxXxx <b>02450H</b>	White dir.laminate Veneer group 1 Veneer group 2	1 437 2 288 2 288	
	Gable 800x400 mm, left, with withdrawable storage	53 31Wxx <b>03330V</b> 53 xxXxx <b>03330V</b> 53 xxXxx <b>03330V</b>	White dir.laminate Veneer group 1 Veneer group 2	2 171 2 816 2 816	
	Gable 800x400 mm, right with withdrawable storage	53 31Wxx <b>03330H</b> 53 xxXxx <b>03330H</b> 53 xxXxx <b>03330H</b>	White dir.laminate Veneer group 1 Veneer group 2	2 171 2 816 2 816	
	Gable, middle, 800x260 mm	53 31W <b>02455</b> 53 xxX <b>02455</b> 53 xxX <b>02455</b>	White dir.laminate Veneer group 1 Veneer group 2	1 525 1 995 1 995	

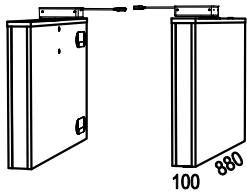
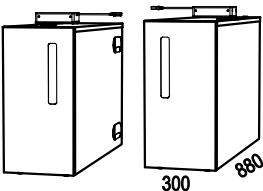
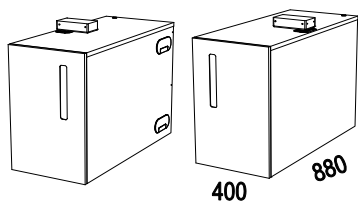
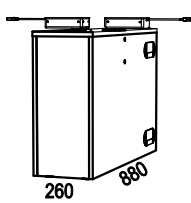
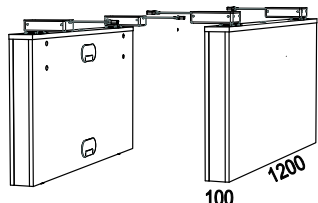
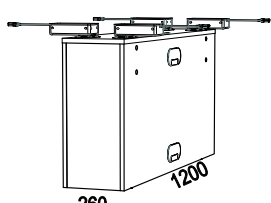
Illustration	Description	Article number	Material	EUR	
<b>Depth 880 mm - for single desk with desk screen</b>					
	Gable 880x100 mm, left	53 31W <b>02500V</b> 53 xxX <b>02500V</b> 53 xxX <b>02500V</b>	White dir.laminate Veneer group 1 Veneer group 2	1 085 1 584 1 584	
	Gable 880x100 mm, right	53 31W <b>02500H</b> 53 xxX <b>02500H</b> 53 xxX <b>02500H</b>	White dir.laminate Veneer group 1 Veneer group 2	1 085 1 584 1 584	
		Gable 880x300 mm, left, with storage	53 31Wxx <b>02505V</b> 53 xxXxx <b>02505V</b> 53 xxXxx <b>02505V</b>	White dir.laminate Veneer group 1 Veneer group 2	1 496 2 406 2 406
		Gable 880x300 mm, right with storage	53 31Wxx <b>02505H</b> 53 xxXxx <b>02505H</b> 53 xxXxx <b>02505H</b>	White dir.laminate Veneer group 1 Veneer group 2	1 496 2 406 2 406
			Gable 880x400 mm, left, with withdrawable storage	53 31Wxx <b>03955V</b> 53 xxXxx <b>03955V</b> 53 xxXxx <b>03955V</b>	White dir.laminate Veneer group 1 Veneer group 2
	Gable 880x400 mm, right, with withdrawable storage		53 31Wxx <b>03955H</b> 53 xxXxx <b>03955H</b> 53 xxXxx <b>03955H</b>	White dir.laminate Veneer group 1 Veneer group 2	2 230 2 934 2 934
	Gable, middle, 880x260 mm		53 31W <b>03075</b> 53 xxX <b>03075</b> 53 xxX <b>03075</b>	White dir.laminate Veneer group 1 Veneer group 2	1 584 2 112 2 112
	<b>Depth 1200 mm</b>				
		Gable 1200x100 mm.	53 31W <b>02460</b> 53 xxX <b>02460</b> 53 xxX <b>02460</b>	White dir.laminate Veneer group 1 Veneer group 2	1 525 2 024 2 024
		Gable, middle, 1200x260 mm.	53 31W <b>02465</b> 53 xxX <b>02465</b> 53 xxX <b>02465</b>	White dir.laminate Veneer group 1 Veneer group 2	2 318 2 816 2 816

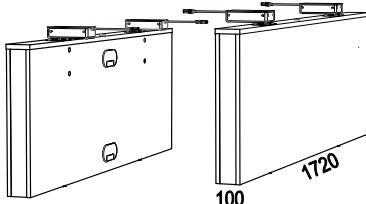
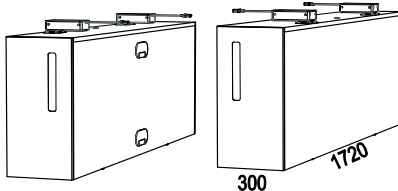
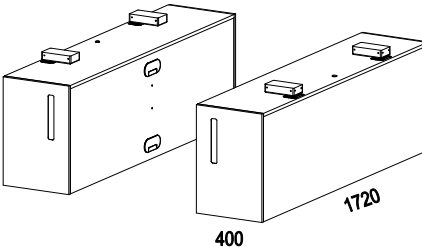
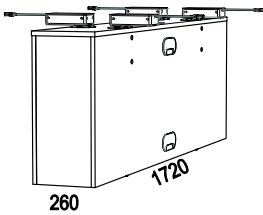
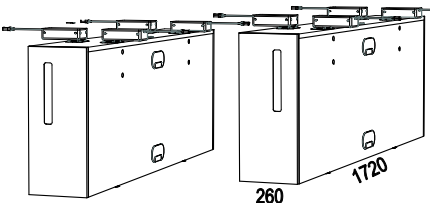
Illustration	Description	Article number	Material	EUR
Depth 1720 mm				
	Gable 1720x100 mm	53 31W <b>02470</b> 53 xxX <b>02470</b> 53 xxX <b>02470</b>	White dir.laminate Veneer group 1 Veneer group 2	1 555 2 054 2 054
	Gable 1720x300 mm, with storage	53 31Wxx <b>02485</b> 53 xxXxx <b>02485</b> 53 xxXxx <b>02485</b>	White dir.laminate Veneer group 1 Veneer group 2	2 230 3 520 3 520
	Gable, 1720x400 mm, with withdrawable storage	53 31Wxx <b>04024</b> 53 xxXxx <b>04024</b> 53 xxXxx <b>04024</b>	White dir.laminate Veneer group 1 Veneer group 2	3 755 4 459 4 459
	Gable, middle, 1720x260 mm	53 31W <b>02475</b> 53 xxX <b>02475</b> 53 xxX <b>02475</b>	White dir.laminate Veneer group 1 Veneer group 2	2 464 3 051 3 051
	Gable, middle, 1720x260 mm, with storage	53 31Wxx <b>02480</b> 53 xxXxx <b>02480</b> 53 xxXxx <b>02480</b>	White dir.laminate Veneer group 1 Veneer group 2	3 081 4 400 4 400





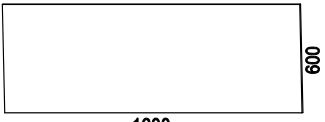
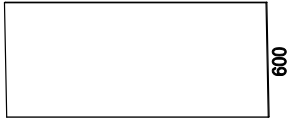
Illustration	Description	Article number	Material	EUR	
<p><b>Nomono SOUND ABSORBING DESK SCREENS</b></p> <ul style="list-style-type: none"> <li>• For mounting in gables</li> <li>• Thickness approx.35 mm, of which 30 mm sound absorber</li> <li>• Fixed height from floor: 120 cm.</li> <li>• Brackets to be ordered separately</li> <li>• For fabric codes: please see the supplier's website</li> </ul>					
<p><b>Price group 1:</b></p> <p><u>Camira:</u> <b>Cara, Carlow</b></p> <p><u>Gabriel:</u> <b>Event Screen, Hush</b></p>		<p><b>Price group 2:</b></p> <p><u>Camira:</u> <b>Blazer Lite</b></p> <p><u>Gabriel:</u> <b>Soul, Soul Mel., Twist, Twist Mel.</b></p> <p><b>Focus Melange Screen, Cura Screen</b></p> <p><u>Kvadrat:</u> <b>Hint</b></p>		<p><b>Price group 3:</b></p> <p><u>Camira:</u> <b>Blazer, Main Line Flax</b></p> <p><u>Gabriel:</u> <b>Step Melange Screen</b></p> <p><u>Kvadrat:</u> <b>Remix, Remix Screen, Floyd Screen</b></p>	
	Sound absorbing desk screen, excluding brackets, length 2000 mm	34 97 <b>04230-x</b>	PG 1	524	
	Brackets	53 37 <b>01069</b>	PG 2 PG 3	619 700	
	Sound absorbing desk screen, excluding brackets, length 1800 mm	34 97 <b>06632-x</b>	PG 1	437	
	Brackets	53 37 <b>01069</b>	PG 2 PG 3	515 583	
	Sound absorbing desk screen, excluding brackets, length 1600 mm	34 97 <b>04207-x</b>	PG 1	377	
	Brackets	53 37 <b>01069</b>	PG 2 PG 3	431 528	
	Sound absorbing desk screen, excluding brackets, length 1400 mm	34 97 <b>07052-x</b>	PG 1	367	
	Brackets	53 37 <b>01069</b>	PG 2 PG 3	420 491	
				126	

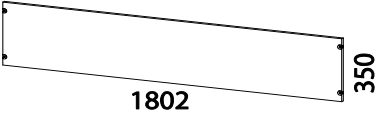
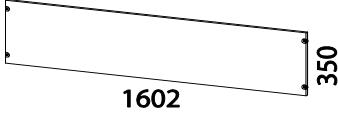
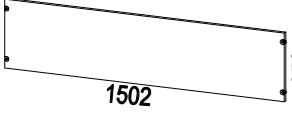

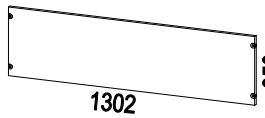
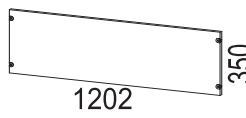
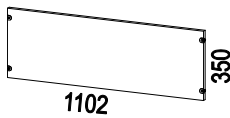
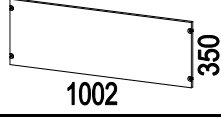

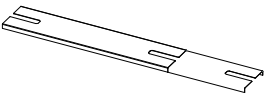

Illustration	Description	Article number	Material	EUR
<b>Nomono FRONT PANELS</b> • Required for single desks with gables without storage in order to obtain sufficient stability. • For single desks with storage the front panels are optional.				
	Front panel 1802x350 mm. For desk: 2000 mm with gables without storage	53 31 <b>80204</b> 53 xx <b>80204</b> 53 xx <b>80204</b>	White dir.laminate Veneer group 1 Veneer group 2	264 411 411
	Front panel 1602x350 mm. For desks: 1800 mm with gables without storage 2000 mm with gable storage one side	53 31 <b>80184</b> 53 xx <b>80184</b> 53 xx <b>80184</b>	White dir.laminate Veneer group 1 Veneer group 2	264 411 411
	Front panel 1502x350 mm. For desk: 2000 mm with gable with withdrawable storage one side	53 31 <b>80205</b> 53 xx <b>80205</b> 53 xx <b>80205</b>	White dir.laminate Veneer group 1 Veneer group 2	264 411 411
	Front panel 1402x350 mm. For desks: 1600 mm with gables without storage 1800 mm with gable w.storage one side	53 31 <b>80164</b> 53 xx <b>80164</b> 53 xx <b>80164</b>	White dir.laminate Veneer group 1 Veneer group 2	264 411 411
	Front panel 1302x350 mm. For desk: 1800 mm with gable with withdrawable storage one side	53 31 <b>80185</b> 53 xx <b>80185</b> 53 xx <b>80185</b>	White dir.laminate Veneer group 1 Veneer group 2	264 411 411
	Front panel 1202x350 mm. For desks: 1400 mm with gables without storage 1600 mm with gable storage one side	53 31 <b>80144</b> 53 xx <b>80144</b> 53 xx <b>80144</b>	White dir.laminate Veneer group 1 Veneer group 2	264 411 411
	Front panel 1102x350 mm. For desk: 1600 mm with gable with withdrawable storage one side	53 31 <b>80165</b> 53 xx <b>80165</b> 53 xx <b>80165</b>	White dir.laminate Veneer group 1 Veneer group 2	264 411 411
	Front panel 1002x350 mm. For desk: 1400 mm with gable storage one side	53 31 <b>80124</b> 53 xx <b>80124</b> 53 xx <b>80124</b>	White dir.laminate Veneer group 1 Veneer group 2	264 411 411
<b>Nomono MIDDLE PANELS</b> • Required for 2-groups (desks placed opposite each other) with gables without storage in order to obtain sufficient stability.				
	Middle panel 1802x200 mm. For desk 2000 mm with gables without storage	53 31 <b>02490-4</b> 53 xx <b>02490-4</b> 53 xx <b>02490-4</b>	White dir.laminate Veneer group 1 Veneer group 2	169 262 262
	Middle panel 1602x200 mm. For desk 1800 mm with gables without storage	53 31 <b>02490-3</b> 53 73 <b>02490-3</b> 53 xx <b>02490-3</b>	White dir.laminate Veneer group 1 Veneer group 2	169 262 262
	Middle panel 1402x200 mm. For desk 1600 mm with gables without storage	53 31 <b>02490-2</b> 53 73 <b>02490-2</b> 53 xx <b>02490-2</b>	White dir.laminate Veneer group 1 Veneer group 2	169 262 262
	Middle panel 1202x200 mm. For desk 1400 mm with gables without storage	53 31 <b>02490-1</b> 53 73 <b>02490-1</b> 53 xx <b>02490-1</b>	White dir.laminate Veneer group 1 Veneer group 2	169 262 262

Illustration	Description	Article number	Material	EUR	
<p><b>Nomono CABLE TRAYS</b></p> <p>• Flexible cable tray for mounting in gables</p> <p style="text-align: right;"><b>31</b> White RAL 9016 <b>37</b> Black RAL 9005</p>					
	Flexible cable tray to single desks and groups side by side. Incl 2xpower 1 cable tray/desk is required.	53 31 <b>03790-2</b> 53 37 <b>03790-2</b>	White Black	237 237	
	Flexible cable tray for groups with 2 desks opposite each other. Ink'cl. 4xpower. 1 cable tray/2 desks is required.	53 31 <b>03790-4</b> 53 37 <b>03790-4</b>	White Black	283 283	
	<i>Not suitable to desk length 1400 mm with withdrawable gable.</i>				
		Lid for flexible cable tray	53 31 <b>03792</b> 53 37 <b>03792</b>	White Black	90 90
		<p><b>Nomono CABLE LID</b></p> <p>• Cable lid made of the same material as the desk top, with MDF edges.</p> <p style="text-align: right;"><b>31</b> White RAL 9016 <b>37</b> Black RAL 9005</p>			
		Extra cost for shutter on desk top. Incl. 3-way standard socket and cable pipe in textile.	53 31 <b>5300xx</b> 53 xx <b>5300xx</b> 53 xx <b>5300xx</b> 53 xx <b>5300xx</b> 53 xx <b>5300xx</b>	White HPL Optional HPL Linoleum Veneer group 1 Veneer group 2	293 293 293 293 293

**Nomono T** Design: Fredrik Mattson

**NOMONO T DESK TOPS**



- Choose desk top from format B or E.
- Complete prices including desk top, frame and electrical T-legs.
- Nomono T desk tops are made of 19 mm MDF with straight edge.
- Height adjustment control (touch pad) always on the right side of the desk top.
- Radius 0.
- Shape rectangular
- The cable box is always placed on the left side of the desk top.

• **Desktop from Forbo Flooring:**

4132 Ash	5502-G
4154 Burgundy	7010-R10B
4166 Charcoal	8502-B
4172 Mauve	7005-Y80R
4174 Conifer	8010-B90G
4175 Pebble	3502-Y
4176 Mushroom	2002-Y
4177 Vapour	2005-G10Y
4179 Smokey Blue	7010-R90B
4184 Olive	5010-G50Y

• **Veneer group 1:**

- Oak nature (03)
- Ash nature (06)

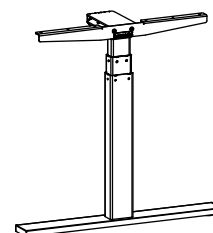
• **Veneer group 2:**

- White pigmented oak (30)
- Black stained ash (86)
- White pigmented ash (10)
- Dark stained ash (76)
- Burgundy stained ash (C8)
- Conifer stained ash (D3)
- Smokey Blue stained ash (D4)

• **High Pressure Laminate:**

	Closest NCS:
White HPL (lam0754)	S0502-Y
Light grey HPL (optional lam 0419)	S2002-Y
Light grey HPL (optional lam 1365)	S2005-R80B
Medium grey HPL (opt. Lam 1023)	S5500-N
Anthracite HPL (opt. lam 1397)	S7500-N
Black HPL (optional lam 2253)	S9000-N

- Electrical T-leg with anti-collision-solution
- Massive feet
- Brackets information is referring to the desk height (inkl the top)
- For additional product information: please see [www.horreds.se](http://www.horreds.se)



**Nomono T** Design: Fredrik Mattson

**B** Desks within size 2000x900 mm

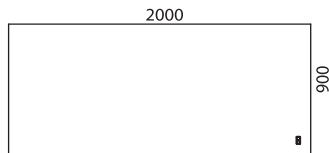
Complete package with desk top, frame and electrical T-legs.

Please replace the first 2 xx in the article number with the material code for the desk top.  
Next 4 xxxx should be replaced with the code for the desk (the code under the desk symbol)

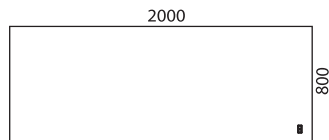
	Colour stand	Article number	White HPL (31)	Optional HPL (39)	Lineoleum (88)	Veneer group 1	Veneer group 2
Desk top incl electrical T-legs (61-126 cm)	White	53B xx xxxxx 31-E	2 183	2 297	2 382	2 189	2 189
	Black	53B xx xxxxx 37-E	2 183	2 297	2 382	2 189	2 189
Desk top only		53B xx xxxxE	521	635	721	528	528

OPTIONS:

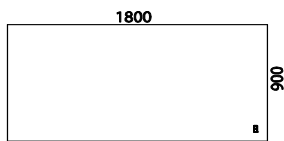
Additional cost for cable box			293	293	293	293	293
-------------------------------	--	--	-----	-----	-----	-----	-----



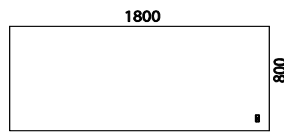
5306E



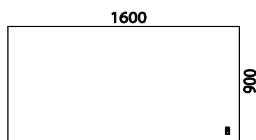
5305E



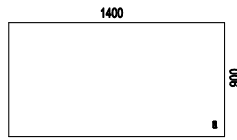
5304E



5303E



5302E



5311E

**Nomono T** Design: Fredrik Mattson

**E** Desks within size 1600x800 mm

Complete package with desk top, frame and electrical T-legs.

Please replace the first 2 xx in the article number with the material code for the desk top.  
Next 4 xxxx should be replaced with the code for the desk (the code under the desk symbol)

	Colour stand	Article number	White HPL (31)	Optional HPL (39)	Lineoleum (88)	Veneer group 1	Veneer group 2
Desk top incl electrical T-legs (61-126 cm)	White	53E xx xxxxx 31-E	2 145	2 180	2 311	2 164	2 164
	Black	53E xx xxxxx 37-E	2 145	2 180	2 311	2 164	2 164
Desk top only		53E xx xxxxE	484	519	650	502	502

OPTIONS:

Additional cost for cable box			293	293	293	293	293
-------------------------------	--	--	-----	-----	-----	-----	-----

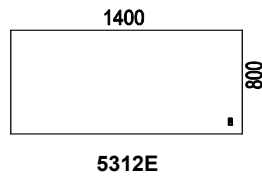
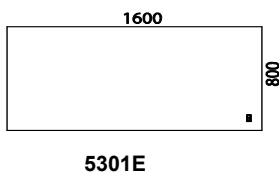
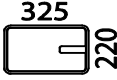
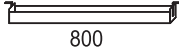
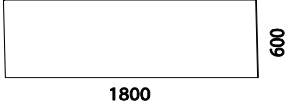
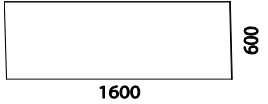
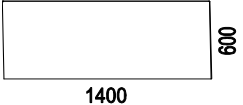




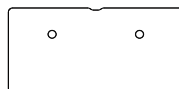
Illustration	Description	Article number	Material	Pris	
<b>Nomono T</b> Design: Fredrik Mattson					
<p><b>Nomono T ACCESSORIES</b></p> <p>The cable lid is made of the same material as the desk top, with MDF edges.</p>					
	Extra cost for shutter on desk top.	53 31 <b>5300xx</b>	White HPL	293	
	Incl. 3-way standard socket and cable pipe in textile.	53 39 <b>5300xx</b>	Optional HPL	293	
		53 88 <b>5300xx</b>	Lineleum	293	
		53 xx <b>5300xx</b>	Veneer gr 1	293	
		53 xx <b>5300xx</b>	Veneer gr 2	293	
	Cable tray. Length 800 mm.	29 31 <b>142</b>	White	102	
	Adjustable in 3 heights	29 37 <b>142</b>	Black	102	
<p><b>Nomono T FABRIC DESK SCREENS</b></p> <ul style="list-style-type: none"> <li>• For mounting in desk top</li> <li>• Thickness approx. 35 mm, of which 30 mm are sound absorbent</li> <li>• Height over desk: 450 mm</li> <li>• Brackets to be ordered separately.</li> <li>• For fabric codes: please see the supplier's website</li> </ul>					
<p><b>Price group 1:</b></p> <p><u>Camira:</u> <b>Cara, Carlow</b></p> <p><u>Gabriel:</u> <b>Event Screen, Hush</b></p>		<p><b>Price group 2:</b></p> <p><u>Camira:</u> <b>Blazer Lite</b></p> <p><u>Gabriel:</u> <b>Soul, Soul Mel., Twist, Twist Mel.</b></p> <p><b>Focus Melange Screen, Cura Screen</b></p> <p><u>Kvadrat:</u> <b>Hint</b></p>		<p><b>Price group 3:</b></p> <p><u>Camira:</u> <b>Blazer, Main Line Flax</b></p> <p><u>Gabriel:</u> <b>Step Melange Screen</b></p> <p><u>Kvadrat:</u> <b>Remix, Remix Screen, Floyd Screen</b></p>	
	Sound absorbing desk screen, Length 1800 mm, excluding brackets	34 97 <b>81800-x</b>	PG 1	380	
	Brackets	34 37 <b>06794-4</b>	PG 2	459	
	Sound absorbing desk screen, Length 1600 mm, excluding brackets	34 97 <b>81600-x</b>	PG 3	526	
	Brackets	34 37 <b>06794-4</b>	svart	93	
	Sound absorbing desk screen, Length 1400 mm, excluding brackets	34 97 <b>81400-x</b>	PG 1	320	
	Brackets	34 37 <b>06794-4</b>	PG 2	374	
			PG 3	471	
			svart	93	
			PG 1	309	
			PG 2	364	
			PG 3	434	
			svart	93	

**Siglo** Design: Henrik Schulz**Siglo** DESK TOPS

- Siglo desk tops in veneer, laminate and linoleum are made of 19 mm MDF with a straight pp-edge. White edge to veneer and matching edge to laminate and linoleum. Additional cost for chamfered edge.
- Siglo desk tops in white direct lam. are made of 19 mm particle board with straight pp-edge.
- Radius 35 mm.
- Siglo has a cut-out for cables as standard. Cable holes against additional fee.

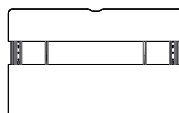
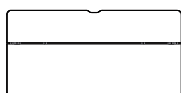


Standard



Med kabelhål (tillval)

- Electric stand, VX11, to be ordered separately. White, black and silver, range 65 cm.
- Siglo sliding tops are always delivered with chamfered edge (included in the price). Veneered tops always have a clear varnished MDF edge. Tops in laminate and linoleum have matching plastic edge. Electric stand and cable tray in felt is included.

• **Linoleum Forbo Flooring:**

4132 Ash (1B)	Closest NCS: 5502-G
4154 Burgundy (1C)	7010-R10B
4166 Charcoal (1G)	8502-B
4172 Mauve (1U)	7005-Y80R
4174 Conifer (1H)	8010-B90G
4175 Pebble (1I)	3502-Y
4176 Mushroom (1J)	2002-Y
4177 Vapour (1K)	2005-G10Y
4179 Smokey Blue (1M)	7010-R90B
4184 Olive (1R)	5010-G50Y

• **High Pressure laminate:**

White HPL (standard 0754)	Closest NCS: S0502-Y
Light grey HPL (opt. lam 0419)	S2002-Y
Light grey HPL (opt. lam 1365)	S2005-R80B
Medium grey HPL (opt. lam 1023)	S5500-N
Anthracite HPL (opt. lam 1397)	S7500-N
Black HPL (optional lam 2253)	S9000-N

• **Veneer group 1:**

Ek natur (03)  
Ask natur (06)

• **Veneer group 2:**

Vitpigmenterad ek (30)  
Vitpigmenterad ask (10)  
Svartbetsad ask (86)  
Mörkbetsad ask (76)  
Burgundy betsad ask (C8)  
Conifer betsad ask (D3)  
Smokey Blue betsad ask (D4)

- For additional product information please see [www.horreds.se](http://www.horreds.se)

**Siglo** Design: Henrik Schulz

**B** Desks within size 1800x900 mm.

Desk tops Siglo with cut-out for cables.

Electric stand VX11 to be ordered separately.

Replace the first 2 xx in the article number with the material code for desk top.

Next 5 xxxxx should be replaced with the code for the desk required (the code under the desk symbol)

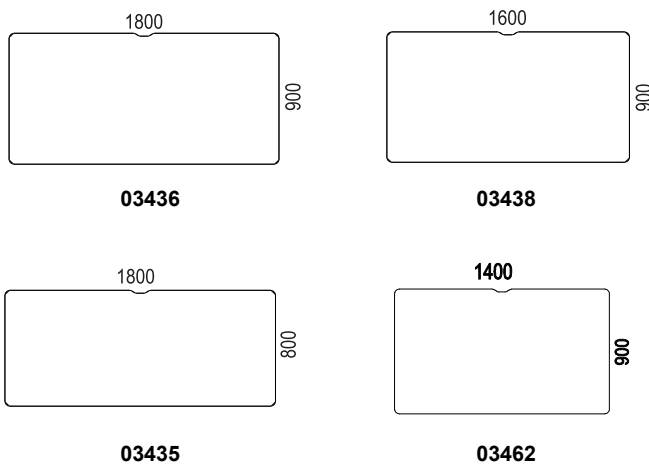
Desk tops Siglo:	Artikelnummer	White direct lam. (31D)	White HPL (31)	Optional HPL (39)	Lino-leum (88)	Veneer group 1	White oak (30) White ash (10) *
Siglo desk top	60B xx 16-xxxxx	310	453	549	701	425	425
* Stained only available with chamfered edge, additional cost:							86

**Electric stand:**

VX11, see Page 42

**Options:**

Chamfered edge Note: not in combination with direct laminate		20	86
Touchpad milled into desk top		343707444	55
Cable holes, incl. 2 lids, white/black	Plastic	60xx03118x2	150
Cable holes, incl. 2 lids	Brass	601603118x2	241
Cable holes, incl. 2 lids	Stainless	601703118x2	241



**Siglo** Design: Henrik Schulz

**E** Desks within size 1600x800 mm.

Desk tops Siglo with cut-out for cables.  
Electric stand VX11 to be ordered separately.

Replace the first 2 xx in the article number with the material code for desk top.  
Next 5 xxxxx should be replaced with the code for the desk required (the code under the desk symbol)

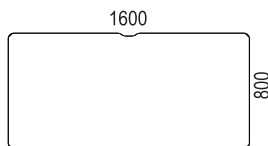
Desk tops Siglo:	Artikelnummer	White direct lam. (31D)	White HPL (31)	Optional HPL (39)	Lino-leum (88)	Veneer group 1	White oak (30) White ash (10) *
Siglo desk top	60E xx 16-xxxxx	299	397	461	650	397	397
* Stained only available with chamfered edge, additional cost:							86

**Electric stand:**

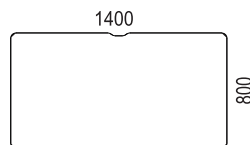
VX11, see page 42

**Options:**

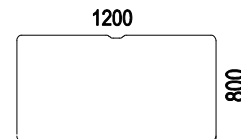
Chamfered edge Note: not in combination with direct laminate		20	86
Touchpad milled into desk top		343707444	55
Cable holes, incl. 2 lids, white/black	Plastic	60xx03118x2	150
Cable holes, incl. 2 lids	Brass	601603118x2	241
Cable holes, incl. 2 lids	Stainless	601703118x2	241



03115



03461



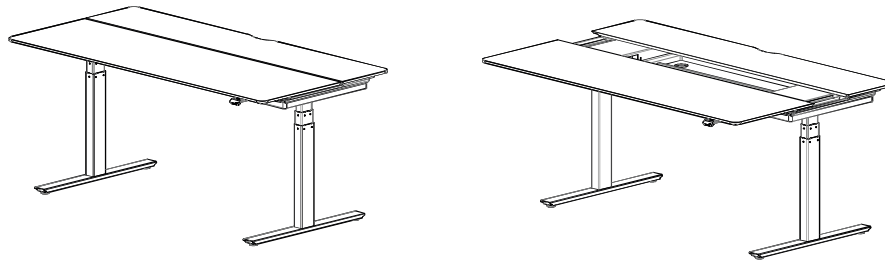
03950\*

\* not available with chamfered edge

**Siglo** Design: Henrik Schulz

**S**

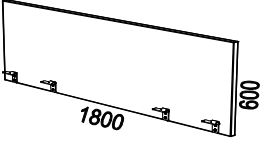
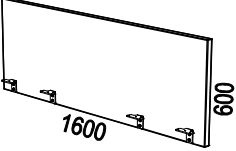
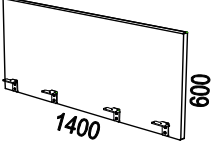
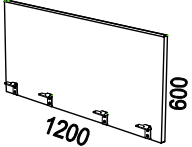
Sliding desk



Complete package including sliding desk top with chamfered edge, frame, electrical T-legs VX8 and grey felt box.

xx in the article number should be replaced with the material code for the desk top.

		Article number	White direct lam. (31D)	White HPL (31)	Optional HPL (39)	Lino-leum (88)	Veneer group 1	Veneer group 2
<b>1800x800:</b>								
Sliding top 1800x800 with electrical adjustable T-legs (61-126 cm)* and grey felt box (art 6003609-2)	White	60B xx 20-03615-31S65		3 253	3 392	3 444	3 128	3 128
	Black	60B xx 20-03615-37S65		3 253	3 392	3 444	3 128	3 128
	Silver	60B xx 20-03615-38S65		3 253	3 392	3 444	3 128	3 128
<b>1600x800:</b>								
Sliding top 1600x800 with electrical adjustable T-legs (61-126 cm)* and grey felt box (art 6003608-2)	White	60E xx 20-03614-31S65		3 166	3 243	3 312	3 041	3 041
	Black	60E xx 20-03614-37S65		3 166	3 243	3 312	3 041	3 041
	Silver	60E xx 20-03614-38S65		3 166	3 243	3 312	3 041	3 041
<b>1400x800:</b>								
Sliding top 1400x800 with electrical adjustable T-legs (61-126 cm)* and grey felt box (art 6003607-2)	White	60E xx 20-03613-31S65		3 144	3 221	3 290	3 019	3 019
	Black	60E xx 20-03613-37S65		3 144	3 221	3 290	3 019	3 019
	Silver	60E xx 20-03613-38S65		3 144	3 221	3 290	3 019	3 019
<b>Options:</b>								
Electronic lock Mifare 13,56 Mhzfor sliding desk incl 1 user card (also includes 1 program card 371401 and 1 service card 371501 per order)		60372020		438				
Extra user card		371781		17				

Illustration	Description	Article number	EUR			
<b>Siglo</b> Design: Henrik Schulz						
<p><b>Siglo</b> SOUND ABSORBING DESK SCREEN</p> <ul style="list-style-type: none"> <li>• Height 600 mm (of which 500 mm over desk)</li> <li>• Thickness 35mm</li> <li>• Including black fittings</li> <li>• 3 different price groups</li> <li>• Also fits sliding desk</li> <li>• For additional product information; please see <a href="http://www.horreds.se">www.horreds.se</a></li> </ul>						
<p><b>Price group 1:</b> <u>Camira:</u> Cara, Carlow <u>Gabriel:</u> Event Screen, Hush</p>		<p><b>Price group 2:</b> <u>Camira:</u> Blazer Lite <u>Gabriel:</u> Soul, Soul Mel, Twist, Twist Mel, Focus Melange Screen, Cura Screen <u>Kvadrat:</u> Hint</p>		<p><b>Price group 3:</b> <u>Camira:</u> Blazer, Main Line Flax <u>Gabriel:</u> Step Melange Screen <u>Kvadrat:</u> Remix, Remix Screen, Floyd Scr.</p>		
	<p>Sound absorbing desk screen 1800x600 mm incl black fittings</p>	<p>60 97 81800-xxx</p>	<p>PG 1 570</p>	<p>PG 2 676</p>	<p>PG 3 775</p>	
	<p>Sound absorbing desk screen 1600x600 mm incl black fittings</p>	<p>60 97 81600-xxx</p>	<p>496</p>	<p>566</p>	<p>711</p>	
	<p>Sound absorbing desk screen 1400x600 mm incl black fittings</p>	<p>60 97 81400-xxx</p>	<p>478</p>	<p>552</p>	<p>658</p>	
	<p>Sound absorbing desk screen 1200x600 mm incl black fittings</p>	<p>60 97 81200-xxx</p>	<p>463</p>	<p>537</p>	<p>606</p>	

# HORREDS WORK DESKS

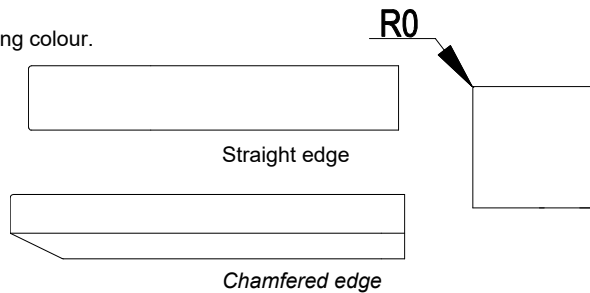


Here is a presentation of our work desks.

For information on desk materials and stands, see next page.

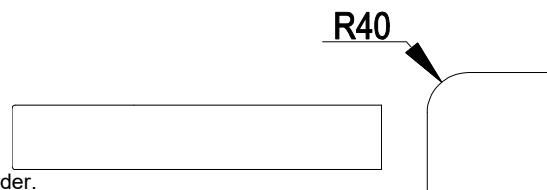
## VX

- VX desk tops are made of 19 mm MDF with edging in matching colour.
- Corner radius 0 mm.
- Option: chamfered edge
- Option: cable entries
- Option: Horreds height adjustment control milled in desk top (touchpad).



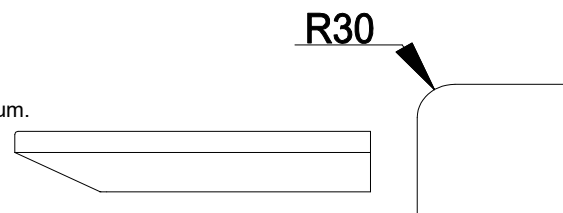
## Henry Design: sandellsandberg

- Henry desk tops are made of 19 mm MDF with white plastic edge.
- Corner radius 40 mm.
- Cable holes with slot as standard unless otherwise stated in the order.
- Option: Horreds height adjustment control milled in desk top (touchpad).



## Fri Design: Bror Boije

- Fri desk tops are made of 19 mm MDF with chamfered edge.
- Clear coated edge on tables in ash, birch, oak, laminate and linoleum.
- Matching colour on stained and white pigmented tables.
- Corner radius 30 mm.
- Option: cable entries
- Option: Horreds height adjustment control milled in desk top (touchpad).





**Desk material**

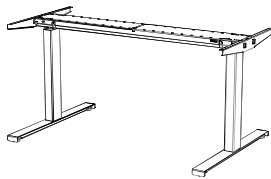
<b>• High Pressure laminate:</b>	Closest NCS:	<b>Linoleum:</b>	Closest NCS:	<b>Veneer group 1:</b>
White HPL (standard 0754)	S0502-Y	4132 Ash	5502-G	Birch (05)
Light grey HPL (opt. lam 0419)	S2002-Y	4154 Burgundy	7010-R10B	Oak (03)
Light grey HPL (opt. lam 1365)	S2005-R80B	4166 Charcoal	8502-B	Ash (06)
Medium grey HPL (opt. lam 1023)	S5500-N	4172 Mauve	7005-Y80R	<b>Veneer group 2:</b>
Anthracite HPL (opt. lam 1397)	S7500-N	4174 Conifer	8010-B90G	White pigmented oak (30)*
Black HPL (optional lam 2253)	S9000-N	4175 Pebble	3502-Y	White pigmented ash (10)*
		4176 Mushroom	2002-Y	Black stained ash (86)*
		4177 Vapour	2005-G10Y	Dark stained ash (76)*
		4179 Smokey Blue	7010-R90B	Burgundy stained ash (C8)*
		4184 Olive	5010-G50Y	Conifer stained ash (D3)*
				Smokey Blue st.ash (D4)*
				(*= <i>not Henry</i> )



**Electric stands**

**VX11:**

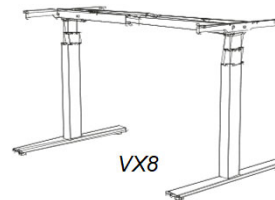
- Has only 0,1 w power consumption in standby mode and is completely PVC-free.
- With anti-collision protection (DS1) and soft start/stop.
- Range 65 cm (table height 61-126 cm)
- Lifting capacity 160 kg, including table top, in widened weighth.
- Complete stand with legs, feet, black flexible frame and hand control under the table.
- Optional: touchpad (hand control milled into desk top).
- Colours: White (RAL9016) / Black (RAL9005) / Silver (RAL 9006)
- Feet in two sizes; 56cm / 71cm.



VX11

**VX8:**

- Has only 0,1 w power consumption in standby mode and is completely PVC-free.
- Lift capacity 60mm/s is standard, 80mm/s is optional..
- Can be programmed in different elevation intervals, has piezo (anti-collision protection) and soft start/stop.
- Range 65 cm (table height 61-126 cm)
- Lifting capacity 140 kg, including table top, in widened weighth
- Premium design with leg profiles without holes / visible sliding pads.
- Complete stand with legs, feet, black flexible frame and hand control under the table.
- Optional: touchpad (hand control milled into desk top)
- Colours: Whjite (RAL9016) and Blakc (RAL9005as sandard, with massive feet as option.
- Available in 8 Horreds optional colours, see page 164.
- Feet in two sizes; 55cm / 70cm.



VX8

**Stand with fixed height**

**VX10:**

- Fixed height 73 cm
- Complete stand with legs, feet, black frame.
- Colours: White (RAL9016) / Black (RAL9005) / Silver (RAL 9006)
- Feet in two sizes; 55cm / 70cm..

• For additional product information please see [www.horreds.se](http://www.horreds.se)

### HORREDS WORK DESKS



**E** Desks within size 1600X800 mm.

Note: Table tops and frames are priced separately.

Table top (excluding stand)	art nr	White HPL (31)	Optional HPL (39)	Linoleum (88)	Veneer group 1	Veneer group 2
<b>Series: Radius: Edge profile:</b>						
VX (3416) 0 mm Straight / matching list	34xx16xxxxE	446	499	609	464	464
VX (3417) 0 mm Chamfered / matching list	34xx17xxxxE	558	611	721	576	576
Henry (80) 40 mm Straight/white pp-list, inc cable hole	80xxxxxE	477	532	691	502	
Fri (3513) 30 mm Chamfered / MDF	35xx13xxxxE	490	544	703	461	461
Option: Horreds touchpad	343707444	55	55	55	55	55
Option: Veneered edge on laminate		104	104			
Option: Veneered edge on linoleum: NB: Only oak/ash nature and white pigmented (not stained!)				104		

Cable holes: Henry has cable hole with slot as standard, for VX and Fri it is optional.

Stands (excl.table top)	Art nr	White (31)	Black (37)	Silver (38)	Horreds opt.colour (xx)
VX11 electric stand, range 65 cm, feet 71 cm	VX11xx657-x	549	549	549	
VX11 electric stand, range 65 cm, feet 56 cm	VX11xx655-x	549	549	549	
VX8 electric stand, range 65 cm	VX8xx2657F2	788	788		931
VX10 fixed height 73 cm	VX10xx2007F2	602	602	602	
Upcharge massive feet 700 mm to VX8+VX10		202	202		

	Rectangular (mm):	Drawing number:		
1600 - 1400 - 1200		VX	Henry	Fri
	1600x800	7025	8402	2068
	1400x800	7024	8419	2067
	1200x800	7023	8523	2066
1600 - 1400 - 700				
	1600x700	7063	8542	2153
	1400x700	7109	8421	2245
	1200x700	7183	8594	2846

## HORREDS WORK DESKS

### **B** Desks within size 2000X900 mm.

Note: Table tops and frames are priced separately.

Table top (excluding stand)	art nr	White HPL (31)	Optional HPL (39)	Linoleum (88)	Veneer group 1	Veneer group 2
<b>Series: Radius: Edge profile:</b>						
VX (3416) 0 mm Straight / matching list	34xx16xxxxB	482	592	702	488	488
VX (3417) 0 mm Chamfered / matching list	34xx17xxxxB	594	704	814	600	600
Henry (80) 40 mm Straight/white pp-list, inc cable hole	80xxxxxB	515	629	788	528	
Fri (3513) 30 mm Chamfered / MDF	35xx13xxxxB	528	642	801	487	487
<i>Option: Horreds touchpad</i>	343707444	55	55	55	55	55
<i>Option: Veneered edge on laminate</i>		104	104			
<i>Option: Veneered edge on linoleum: NB: Only oak/ash nature and white pigmented (not stained!)</i>				104		

Cable holes: Henry has cable hole with slot as standard, for VX and Fri it is optional.

Stands (excl. table top)	Art nr	White (31)	Black (37)	Silver (38)	Horreds opt.colour (xx)
VX11 electric stand, range 65cm <b>Note: max desk length 1800 mm.</b>	VX11xx657-x	549	549	549	
VX8 electric stand, range 65cm	VX8xx2657F2	788	788		931
VX10 fixed height 73 cm	VX10xx2007F2	602	602	602	
<i>Upcharge massive feet 700 mm to VX8+VX10</i>		202	202		

Drawing number:

	Rectangular (mm):	VX	Henry	Fri
	2000x900	7037	8403	2341
	2000x800	7027	8404	2069
	1800x900	7036	8405	2662
	1800x800	7026	8401	2028
	1600x900	7035	8408	2729
	Magbord (mm):			
	2000x900			2447
	1800x900			3149
	Magbord (mm):			
	2000x900			3701
	1800x900			3013
	1600x900			2980

## HORREDS SKRIVBORD

**C** Desks within size 1200X600 mm.

Note: Table tops and frames are priced separately.

Table top (excluding stand)	art nr	White HPL (31)	Optional HPL (39)	Linoleum (88)	Veneer group 1	Veneer group 2
<b>Series: Radius: Edge profile:</b>						
VX (3416) 0 mm Straight / matching list	34xx16xxxxC	395	425	513	392	392
VX (3417) 0 mm Chamfered / matching list	34xx17xxxxC	507	537	625	504	504
Henry (80) 40 mm Straight/white pp-list, inc cable hole	80xxxxxC	426	559	594	430	
Fri (3513) 30 mm Chamfered / MDF	35xx13xxxxC	439	465	607	389	389
<i>Option: Horreds touchpad</i>	343707444	55	55	55	55	55
<i>Option: Veneered edge on laminate</i>		104	104			
<i>Option: Veneered edge on linoleum: NB: Only oak/ash nature and white pigmented (not stained!)</i>				104		

*Cable holes: Henry has cable hole with slot as standard, for VX and Fri it is optional.*

Stands (excl.table top)	Art nr	White (31)	Black (37)	Silver (38)	Horreds opt.colour (xx)
VX11 electric stand, range 65 cm	VX11xx655-x	549	549	549	
VX8 electric stand, range 65 cm	VX8xx2655F2	788	788		931
VX10 stand, fixed height 73 cm	VX10xx2005F2	602	602	602	

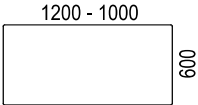


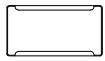
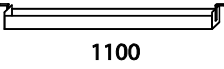
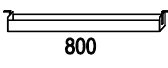
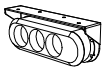
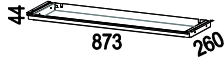
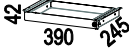
	Rectangular (mm):	Drawing number:		
		VX	Henry	Fri
	1200x600	7013	8513	2162
1000x600	7012	8567	2139	

Illustration	Description	Article number	Material	EUR					
<b>CABLE ENTRIES &amp; CABLE TRAYS FOR DESKS</b>									
<ul style="list-style-type: none"> <li>• Cable entries, diameter 80 mm, including lid.</li> <li>• For desks in series Fri and VX.</li> <li>• If other entry than our standard; please contact customer service for price.</li> </ul>									
Entry codes									
	Cable entry 80 mm, including lid in plastic	<b>3931850</b>	white	Y1	Y2	Y3	Y4	Y5	Y8
		<b>3937850</b>	black	32	32	32	38	38	38
	Lid only	<b>573180</b>	white	6					
		<b>573780</b>	black	6					
<b>Power dot entries 80mm</b>				<b>Y1</b>	<b>Y2</b>	<b>Y3</b>			
	Powerdot cable entry 80 mm with 1xpower and 4 Magic Holes	<b>935-PD10</b>	black	66	66	66			
		<b>935-PD10W</b>	white	66	66	66			
	Powerdot cable entry 80 mm. 1 power, 2 USB-C charger (2x30W), 1 magic hole ø8 mm).	<b>935-PD17</b>	black	190	190	190			
		<b>935-PD17W</b>	white	190	190	190			
<b>Power dot entries 60mm</b>				<b>F1</b>	<b>F2</b>	<b>F3</b>			
	Powerdot cable entry 60 mm 1 x power + 1 x USB-A charger	<b>935-PM61</b>	black	103	103	103			
		<b>935-PM61W</b>	white	103	103	103			
	Powerdot cable entry 60 mm 1 x power + 1 x USB-C PD charger	<b>935-PM62</b>	black	144	144	144			
		<b>935-PM62W</b>	white	144	144	144			
	Axessline cordless charger ø 60 mm. Qi-standard for smartphones	<b>935-QI60B</b>	black	176	176	176			
		<b>935-QI60W</b>	white	176	176	176			

Illustration	Description	Article number	Material	EUR		
	<b>Power dot entries 51mm</b>			Entry codes		
				D1	D2	D3
	Powerdot cable entry <b>51</b> mm. 1 power.	<b>935-PM50</b> <b>935-PM50W</b>	Svart Vit	63 63	63 63	63 63
	Powerdot cable entry <b>51</b> mm. 2 USB-C PD charger	<b>935-PM52</b> <b>935-PM52W</b>	Svart Vit	144 144	144 144	144 144
	Cable entries 30mm			J1	J2	J3
	Powerdot cable entry <b>30</b> mm 2 x USB-A charger	<b>935-PM30</b> <b>935-PM30W</b>	Svart Vit	89 89	89 89	89 89
	Powerdot cable entry <b>30</b> mm 1 x USB-A and 1 USB-C charger	<b>935-PM32</b> <b>935-PM32W</b>	Svart Vit	140 140	140 140	140 140
	Cable entry including lid 233x128 in Same material as desk top Note: no matching of veneer	<b>57xx6253K</b>		R1 center	R2 right	R3 left
	Cable entry, customized (without lid)	<b>HAL1</b>		115		
	Cable tray. Length 1100 mm. Adjustable 3 heights.. Minimum desk length: 1400 mm.	<b>2937140</b> <b>2931140</b> <b>2938140</b>	silver white silver	102 102 102		
	Cable tray. Length 800 mm. Adjustable 3 heights.	<b>2937142</b> <b>2931142</b> <b>2938142</b>	black white silver	102 102 102		
	Power socket, 3-ways, with bracket.	<b>343707434</b>	black	97		
	Power socket 3-ways, 3 m cable	<b>936-E3V30B</b>	black	27		
	Power socket 6-ways, 3 m cable	<b>936-E6V30B</b>	black	32		
	Cable pipe ø 20mm in braided textile. Length 1500 mm. With zipper.	<b>3254000109</b> <b>3254000101</b>	black white	40 40		
	Cable pipe in textile. Length 1500 mm.	<b>29371500</b> <b>29311500</b>	black white	119 119		
	Cable cover 1300 mm i tyg (Gabriel Runner 60999)	<b>341300-600</b>	black	87		

**ACCESSORIES DESKS**

• For additional product information: please see [www.horreds.se](http://www.horreds.se)

	Metallic pen drawer 390x245x42 mm,	<b>4048</b>	black	229
	Metallic pen drawer 390x245x42 mm, with lock.	<b>4015-L</b>	black	191

**VX****VX8 & VX11 STANDS**

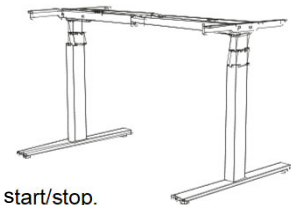
VX8 is the premium stand option, available in 10 colours and completely PVC-free.

Anti-collision, 60mm/s lifting speed and 140kg lifting capacity are standard.

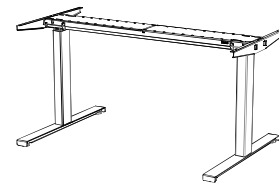
VX11 is a stand with easy assembly. The four parts of the concept are carefully designed to either click together or to be attached with a few screws. The beam is the heart of the system because the motor, electronics and wiring already are pre-assembled.

**VX8 ELECTRICAL STAND**

- Has only 0,1 w power consumption in standby mode and is completely PVC-free.
- Lift capacity 60mm/s is standard, 80mm/s is optional..
- Can be programmed in different elevation intervals, has piezo (anti-collision protection) and soft start/stop.
- Range 65 cm (table height 61-126 cm)
- Lifting capacity 140 kg, including table top, in widened weight.
- Premium design with leg profiles without holes / visible sliding pads.
- Complete stand with legs, feet, black flexible frame and hand control under the table.
- Optional: touchpad (hand control milled into desk top)
- Colours: White (RAL9016) and Black (RAL9005) as standard, with massive feet as option..
- Available in 8 Horreds optional colours, see page 164.
- Feet in two sizes; 55cm / 70cm.

**VX11 ELECTRICAL STAND**

- Has only 0,1 w power consumption in standby mode and is completely PVC-free.
- With anti-collision protection (DS1) and soft start/stop.
- Range 65 cm (table height 61-126 cm)
- Lifting capacity 160 kg, including table top, in widened weight.
- Complete stand with legs, feet, black flexible frame and hand control under the table.
- Optional: touchpad (hand control milled into desk top)
- Colours: White (RAL9016) / Black (RAL9005) / Silver (RAL 9006)
- Feet in two sizes; 56cm / 71cm.

**VX10 T-LEGS**

- Fixed height 73 cm.
- Complete stand with legs, feet, black frame.
- Colours: White (RAL9016) / Black (RAL9005) / Silver (RAL 9006)
- Feet in two sizes; 55cm / 70cm.

- For additional product information please see [www.horreds.se](http://www.horreds.se)



Description	Art.nr	EUR
<b>VX STANDS WITH T-LEGS</b>		
<p>VX11 with desk depth 800-900mm is delivered with feet 710mm, table depth 600-700mm with feet 560mm.                      VX8 with desk depth 800-900mm is delivered with feet 700mm, table depth 600-700mm with feet 550mm.                      VX10 with desk depth 800-900mm is delivered with feet 700mm, table depth 600-700mm with feet 550mm.</p> <p><b>Standard colours RAL VX10 / VX11:</b> White 9016 (31), Black 9005 (37), Grey 9006 (38)</p> <p><b>Standard colours RAL VX8:</b> White 9016 (31), Black 9005 (37)</p> <p><b>Optional colours RAL VX8:</b>                      1019 Grey beige (3H), 1024 Ochre yellow (3G), 3007 Black red (3D), 5008 Grey blue (3C)                      6009 Fir green (3L), 6013 Reed green (3K), 7039 Quartz grey (3J), 7044 Silk grey (3A)</p>		

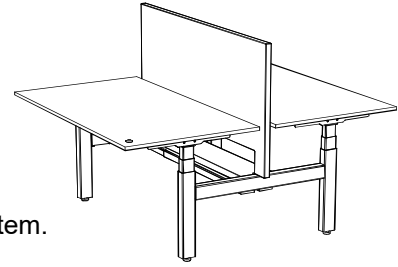
VX11	Article number	White (31) Black (37) Grey (38)
<b>T-stand with flexible frame 1156-1756 mm, range 650mm</b>		
VX11 to desk length 1200-1800mm and depth 800-900mm, feet 710mm	VX11xx657-x	549
VX11 till desk length 1200-1800mm and depth 600-700mm, feet 560mm	VX11xx655-x	549
Disassembly tool VX11	SA1023W1241	19

VX8	Article number	White (31) Black (37)	Horreds optional colours
<b>T-stand with flexible frame (choose F1, F2, F3) feet 700mm / 550mm</b>			
VX8, range 650mm, for desk length 1100-1600mm	VX8xx265xF1	788	931
VX8, range 650mm, for desk length 1300-1700mm	VX8xx265xF2	788	931
VX8, range 650mm, for desk length 1600-2200mm	VX8xx265xF3	788	931
<b>Option: High Speed 80mm/s lifting capacity</b>		17	17
<b>Option: Massive feet 700mm (white/black)</b>	52xx02640	202	

VX10	Article number	White (31) Black (37) Grey (38)
<b>T-bensstativ med fast höjd, flexibel sarg (välj F1, F2, F3) fot 700mm / 550mm</b>		
VX10, desk height 730mm, for table lengths 1100-1600mm	VX8xx265xF1	602
VX10, desk height 730mm, for table lengths 1300-1700mm	VX8xx265xF2	602
VX10, desk height 730mm, for table lengths 1600-2200mm	VX10xx200xF3	602
<b>Option: Massive feet 700mm (white/black only)</b>	52xx02640	202

**VX DUO**

**D** DOUBLE STAND

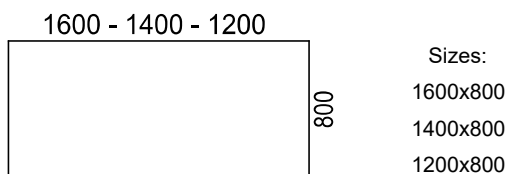
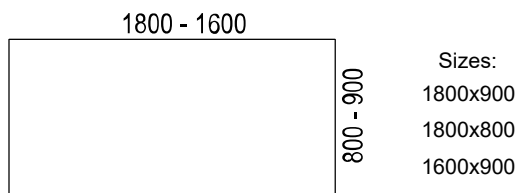


Complete package containing 2 pcs VX table top and 1 Duo stand.  
Duo stand with Piezo anti-collision, High Speed (80mm/s), PVC-free system.

	Colour	Article number	White HPL (31)	Optional HPL (39)	Linoleum (88)	Veneer group 1	Veneer group 2
<b>1800x900, 1800x800, 1600x900mm:</b> 2 x table tops and 1 x Duo stand. (60-125 cm)	White	3431DUOxxx	2 805	3 035	3 245	2 816	2 816
	Black	3437DUOxxx	2 805	3 035	3 245	2 816	2 816
<b>1600x800, 1400x800, 1200x800mm:</b> 2 x table tops and 1 x Duo stand. (60-125 cm)	White	3431DUOxxx	2 733	2 838	3 058	2 769	2 769
	Black	3437DUOxxx	2 733	2 838	3 058	2 769	2 769

TILLVAL:

Flexible cable tray with lid	White	34311870	178				
Flexible cable tray with lid	Black	34371870	178				
Option: Horreds touchpad. Price per desk	Black	343707444	63				
Option: Veneered edge on laminate			104				
Option: Veneered edge on linoleum*			104				*only clear coated and white pigmented oak/ash
Cable entries and accessories		See page 39					
Desk screens, table-mounted		See page 45					
Desk screen mounted in the stand		See next page					



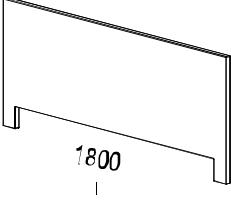
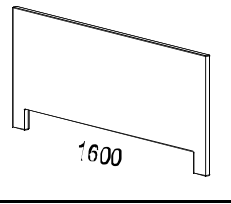
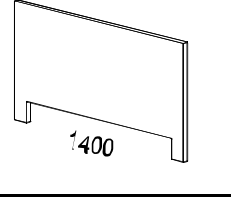
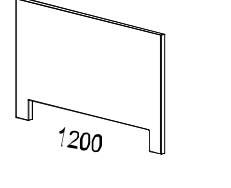
<b>VX DUO DESK SCREENS IN FABRIC</b> • For mounting in VX Duo stand. • Thickness approx.ca 35 mm, of which 30mm sound absorbent. • Fixed height 12cm above floor. • Brackets are ordered separatley. Choose white or black. • Don't forget to enter the colour code; see respectively fabric supplier's website.				
<b>Price group 1:</b> Camira: <b>Cara, Carlow</b> Gabriel: <b>Event Screen, Hush</b>	<b>Price group 2:</b> Camira: <b>Blazer Lite</b> Gabriel: <b>Soul, Soul Mel., Twist, Twist Mel.</b> <b>Focus Melange Screen, Cura Screen</b> Kvadrat: <b>Hint Screen</b>	<b>Price group 3:</b> Camira: <b>Blazer, Main Line Flax</b> Gabriel: <b>Step Melange Screen</b> Kvadrat: <b>Remix, Remix Screen, Floyd Screen</b>		
	Sound absorbing desk screen Lenght 1800 mm, exklusive beslag  Brackets	34 97 <b>09440</b>  34 xx <b>09441</b>	PG 1 PG 2 PG 3 white/black	332 404 470 34
	Sound absorbing desk screen Lenght 1600 mm, exklusive beslag  Brackets	34 97 <b>09439</b>  34 xx <b>09441</b>	PG 1 PG 2 PG 3 white/black	301 361 432 34
	Sound absorbing desk screen Lenght 1400 mm, exklusive beslag  Brackets	34 97 <b>09438</b>  34 xx <b>09441</b>	PG 1 PG 2 PG 3 white/black	279 332 397 34
	Sound absorbing desk screen Lenght 1200 mm, exklusive beslag  Brackets	34 97 <b>09437</b>  34 xx <b>09441</b>	PG 1 PG 2 PG 3 white/black	265 314 364 34



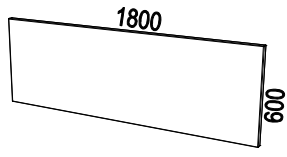
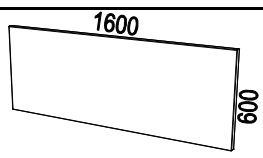
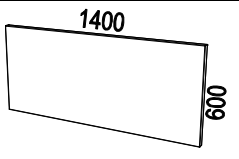
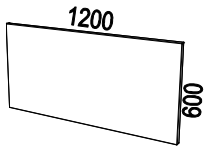
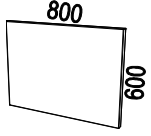
Illustration	Description	Article number	EUR		
<b>VX</b>					
	<p><b>VX sound absorbing desk screen</b></p> <ul style="list-style-type: none"> <li>• Height 600 mm (of which 500 mm over desk).</li> <li>• Two different corner edges: radius 0 and radius 50.</li> <li>• Thickness 35 mm, of which 30 mm sound absorber</li> <li>• Specification sound absorbent:                             <ul style="list-style-type: none"> <li>- 30 mm polyester wadding (1000g/m2)</li> <li>- 100% polyester, up to 80% regenerated fibres</li> <li>- Certified according to Ökotex, class 1.</li> </ul> </li> <li>• Max weight capacity 25 kg.</li> <li>• Fittings to be ordered separately.</li> <li>• Also suitable for desks Henry and Fri.</li> <li>• For fabric codes: please see the supplier's website</li> <li>• For additional product information, please see <a href="http://www.horreds.se">www.horreds.se</a></li> </ul>				
<p><b>Price group 1:</b> Camira: <b>Cara, Carlow</b> Gabriel: <b>Event Screen, Hush</b></p>		<p><b>Price group 2:</b> Camira: <b>Blazer Lite</b> Gabriel: <b>Soul, Soul Mel, Twist, Twist Mel, Focus Melange Screen, Cura Screen</b> Kvadrat: <b>Hint</b></p>		<p><b>Price group 3:</b> Camira: <b>Blazer, Main Line Flax</b> Gabriel: <b>Step Melange Screen</b> Kvadrat: <b>Remix, Remix Screen, Floyd Scr.</b></p>	
			PG 1	PG 2	PG 3
	<p>Sound absorbing desk screen, straight corners. Lenght 1800 mm, exkl brackets</p> <p>Brackets, 4-pcs, black</p>	<p>34 97 <b>81800-x</b></p> <p>34 37 <b>06794-4</b></p>	380 93	459 93	526 93
	<p>Sound absorbing desk screen, straight corners. Lenght 1600 mm, exkl brackets</p> <p>Brackets, 4-pcs, black</p>	<p>34 97 <b>81600-x</b></p> <p>34 37 <b>06794-4</b></p>	320 93	374 93	471 93
	<p>Sound absorbing desk screen, straight corners. Lenght 1400 mm, exkl brackets</p> <p>Brackets, 4-pcs, black</p>	<p>34 97 <b>81400-x</b></p> <p>34 37 <b>06794-4</b></p>	309 93	364 93	434 93
	<p>Sound absorbing desk screen, straight corners. Lenght 1200 mm, exkl brackets</p> <p>Brackets, 3-pcs, black</p>	<p>34 97 <b>81200-x</b></p> <p>34 37 <b>06794-3</b></p>	299 77	353 77	400 77
	<p>Sound absorbing desk screen, straight corners. Lenght 800 mm, exkl brackets</p> <p>Brackets, 2-pcs, black</p>	<p>34 97 <b>08354-x</b></p> <p>34 37 <b>06780</b></p>	200 58	237 58	268 58

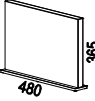
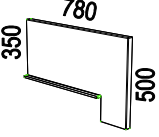

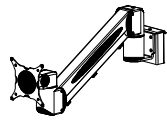

Illustration	Description	Article number	EUR		
			PG 1	PG 2	PG 3
	Sound absorbing desk screen, 480x365x35 mm. Incl foot in laquered steel. Choose colour of foot: white or black.	34 xx <b>03374-x</b>	292	310	338
	Sound absorbing desk screen, 780x365x35 mm. Incl foot in laquered steel. Choose colour of foot: white or black.	34 xx <b>06360-x</b>	362	398	434
<b>Tillbehör till VX bordsskärmar</b>					
			Material	EUR	
	Accessory strip in extruded aluminum. Can be attached to the table screen or to the wall.				
	Freewall 1750 mm	<b>670 175</b>	Silver	175	
		<b>670 175-1</b>	Vit	175	
	Freewall 1550 mm	<b>670 155</b>	Silver	160	
		<b>670 155-1</b>	Vit	160	
	Freewall 1350 mm	<b>670 135</b>	Silver	141	
		<b>670 135-1</b>	Vit	141	
	Monitor arm D-Zine Toolbar 3 (1,5-8,5 kg) To be attached in Freewall. VESA 75 och 100.	<b>611 325</b> <b>611 325-1</b>	Silver Vit	403 403	
<b>Tillbehör till VX fristående sidoskärm</b>					
	Pennfack till fristående sidoskärm	34 31 <b>03357</b>	Vit	68	
		34 37 <b>03357</b>	Svart	68	


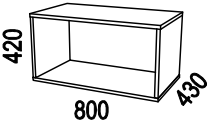
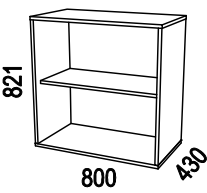
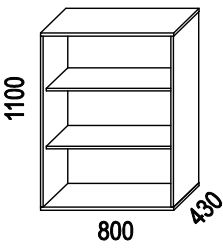
Illustration	Description	Article number	Material	EUR
<p><b>STORAGE BASIC UNITS</b></p>  <ul style="list-style-type: none"> <li>• Basic unit in direct laminated or veneered particle board</li> <li>• White direct laminate = closest NCS S0300-N</li> <li>• Stationary shelves</li> <li>• For additional product information; please see <a href="http://www.horreds.se">www.horreds.se</a></li> </ul> <p><u>Veneer group 1:</u> Birch (05), Oak (03), Ash (06).</p> <p><u>Veneer group 2:</u> White pigmented Oak (30), White pigmented Ash (10), Black stained Ash (86), Dark stained Ash (76).</p> <p>Note! Price is for basic unit only</p> <ul style="list-style-type: none"> <li>• Base to be ordered separately.</li> <li>• Sliding doors to be ordered separately.</li> </ul>				
<b>WIDTH 800 MM:</b>				
	<p>Basic unit 800x420x430 mm. 1xA4-height prepared for sliding doors.</p> <p>As above but <b>not</b> prepared for sliding doors</p>	<p>57 31 <b>71310</b> 57 xx <b>71310</b> 57 xx <b>71310</b></p> <p>57 31 <b>71300</b> 57 xx <b>71300</b> 57 xx <b>71300</b></p>	<p>White direct lam. Veneer group 1 Veneer group 2</p> <p>White direct lam. Veneer group 1 Veneer group 2</p>	<p>427 662 662</p> <p>427 662 662</p>
	<p>Basic unit 800x821x430 mm. 2xA4-height prepared for sliding doors.</p> <p>As above but <b>not</b> prepared for sliding doors</p>	<p>57 31 <b>72310</b> 57 xx <b>72310</b> 57 xx <b>72310</b></p> <p>57 31 <b>72300</b> 57 xx <b>72300</b> 57 xx <b>72300</b></p>	<p>White direct lam. Veneer group 1 Veneer group 2</p> <p>White direct lam. Veneer group 1 Veneer group 2</p>	<p>467 863 863</p> <p>467 863 863</p>
	<p>Basic unit 800x1100x430 mm. 3xA4-height prepared for sliding doors.</p> <p>As above but <b>not</b> prepared for sliding doors</p>	<p>57 31 <b>73310</b> 57 xx <b>73310</b> 57 xx <b>73310</b></p> <p>57 31 <b>73300</b> 57 xx <b>73300</b> 57 xx <b>73300</b></p>	<p>White direct lam. Veneer group 1 Veneer group 2</p> <p>White direct lam. Veneer group 1 Veneer group 2</p>	<p>596 1 181 1 181</p> <p>596 1 181 1 181</p>

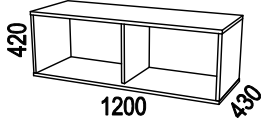
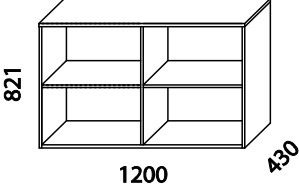
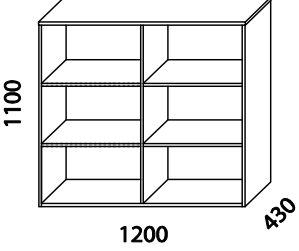
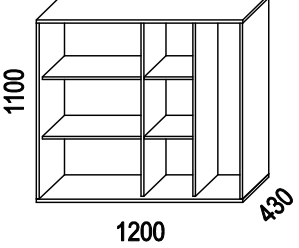
Illustration	Description	Article number	Material	EUR
<b>WIDTH 1200 MM:</b>				
	Basic unit 1200x420x430 mm. 1xA4-height prepared for sliding doors.	57 31 <b>71510</b>	White direct lam.	484
		57 xx <b>71510</b>	Veneer group 1	877
		57 xx <b>71510</b>	Veneer group 2	877
	As above but <b>not</b> prepared for sliding doors	57 31 <b>71500</b>	White direct lam.	484
		57 xx <b>71500</b>	Veneer group 1	877
		57 xx <b>71500</b>	Veneer group 2	877
	Basic unit 1200x821x430 mm. 2xA4-height prepared for sliding doors.	57 31 <b>72510</b>	White direct lam.	563
		57 xx <b>72510</b>	Veneer group 1	1 159
		57 xx <b>72510</b>	Veneer group 2	1 159
	As above but <b>not</b> prepared for sliding doors	57 31 <b>72500</b>	White direct lam.	563
		57 xx <b>72500</b>	Veneer group 1	1 159
		57 xx <b>72500</b>	Veneer group 2	1 159
	Basic unit 1200x1100x430 mm. 3xA4-height prepared for sliding doors.	57 31 <b>73510</b>	White direct lam.	643
		57 xx <b>73510</b>	Veneer group 1	1 223
		57 xx <b>73510</b>	Veneer group 2	1 223
	As above but <b>not</b> prepared for sliding doors	57 31 <b>73500</b>	White direct lam.	643
		57 xx <b>73500</b>	Veneer group 1	1 223
		57 xx <b>73500</b>	Veneer group 2	1 223
	Basic unit 1200x1100x430 mm with wardrobe compartment. 3xA4-height, prepared for sliding doors.	57 31 <b>73512</b>	White direct lam.	866
		57 xx <b>73512</b>	Veneer group 1	1 531
		57 xx <b>73512</b>	Veneer group 2	1 531

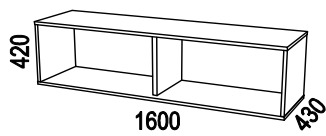
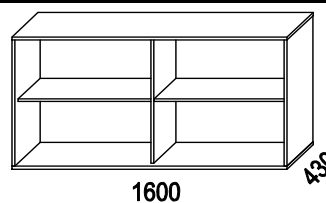
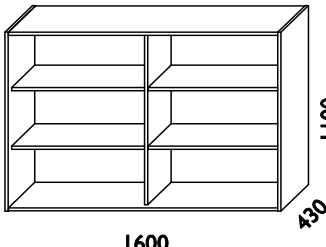
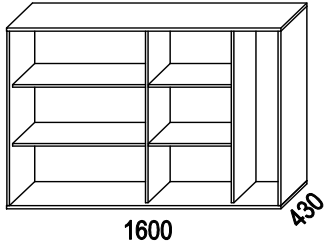
Illustration	Description	Article number	Material	EUR
<b>WIDTH 1600 MM:</b>				
	Basic unit 1600x420x430 mm. 1xA4-height, prepared for sliding doors.	57 31 <b>71710</b>	White direct lam.	616
		57 xx <b>71710</b>	Veneer group 1	1 035
		57 xx <b>71710</b>	Veneer group 2	1 035
	As above but <b>not</b> prepared for sliding doors	57 31 <b>71700</b>	White direct lam.	616
		57 xx <b>71700</b>	Veneer group 1	1 035
		57 xx <b>71700</b>	Veneer group 2	1 035
	Basic unit 1600x821x430 mm. 2xA4-height, prepared for sliding doors.	57 31 <b>72710</b>	White direct lam.	686
		57 xx <b>72710</b>	Veneer group 1	1 395
		57 xx <b>72710</b>	Veneer group 2	1 395
	As above but <b>not</b> prepared for sliding doors	57 31 <b>72700</b>	White direct lam.	686
		57 xx <b>72700</b>	Veneer group 1	1 395
		57 xx <b>72700</b>	Veneer group 2	1 395
	Basic unit 1600x1100x430 mm. 3xA4-height, prepared for sliding doors.	57 31 <b>73710</b>	White direct lam.	858
		57 xx <b>73710</b>	Veneer group 1	1 511
		57 xx <b>73710</b>	Veneer group 2	1 511
	As above but <b>not</b> prepared for sliding doors	57 31 <b>73700</b>	White direct lam.	858
		57 xx <b>73700</b>	Veneer group 1	1 511
		57 xx <b>73700</b>	Veneer group 2	1 511
	Basic unit 1600x1100x430 mm with wardrobe compartment. 3xA4-height, prepared for sliding doors.	57 31 <b>73712</b>	Vit direktlaminat	1 016
		57 xx <b>73712</b>	Faner grupp 1	1 866
		57 xx <b>73712</b>	Faner grupp 2	1 866




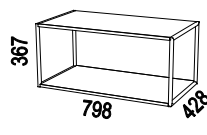
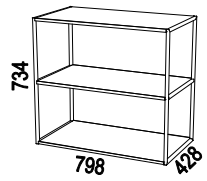
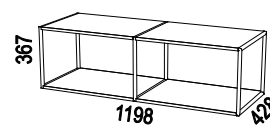
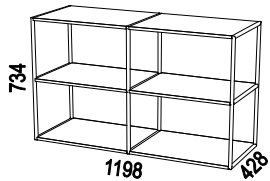
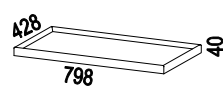
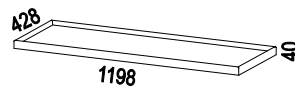
Illustration	Description	Article number	Material	EUR
<b>Biblio</b> Design: Anderssen & Voll				
 <b>BIBLIO EXTENSION UNITS</b> <ul style="list-style-type: none"> <li>• Metallic extension unit I: white (RAL 9016 str) and black (RAL 9005 str)</li> <li>• Shelves: <ul style="list-style-type: none"> <li>-White lacquer NCS S0300-N</li> <li>-Veneer group 1: Oak (03), Ash (06)</li> <li>- Veneer group 2: Black ash (86), Dark ash (76), White oak (30), White ash (10)</li> </ul> </li> <li>• For additional product information see <a href="http://www.horreds.se">www.horreds.se</a></li> </ul>				
	Extension unit 798x367x428 mm	64 xx31 <b>-0801</b>	White shelves	533
	in white or black metal with shelves	64 xxxx <b>-0801</b>	Veneer gr 1 shelves	669
	in white lacquer or veneer	64 xxxx <b>-0801</b>	Veneer gr 2 shelves	669
	Extension unit 798x734x428 mm	64 xx31 <b>-0802</b>	White shelves	651
	in white or black metal with shelves	64 xxxx <b>-0802</b>	Veneer gr 1 shelves	866
	in white lacquer or veneer	64 xxxx <b>-0802</b>	Veneer gr 2 shelves	866
	Extension unit 1198x367x428 mm	64 xx31 <b>-1201</b>	White shelves	764
	in white or black metal with shelves	64 xxxx <b>-1201</b>	Veneer gr 1 shelves	1 028
	in white lacquer or veneer	64 xxxx <b>-1201</b>	Veneer gr 2 shelves	1 028
	Extension unit 1198x734x428 mm	64 xx31 <b>-1202</b>	White shelves	1 093
	in white or black metal with shelves	64 xxxx <b>-1202</b>	Veneer gr 1 shelves	1 459
	in white lacquer or veneer	64 xxxx <b>-1202</b>	Veneer gr 2 shelves	1 459
<b>BIBLIO TRAYS</b> <ul style="list-style-type: none"> <li>• Tray in veneer with massive edges.</li> <li>-Veneer group 1: Oak (03), Ash (06)</li> <li>- Veneer group 2: Black ash (86), Dark ash (76), White oak (30), White ash (10)</li> <li>• For additional product information see <a href="http://www.horreds.se">www.horreds.se</a></li> </ul>				
	Tray 798x428x40 mm	64 xx <b>07525-080</b>	Veneer group 1	474
			Venner group 2	474
	Tray 1198x428x40 mm	64 xx <b>07525-120</b>	Veneer group 1	500
			Venner group 2	500

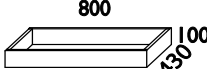
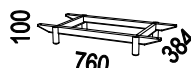
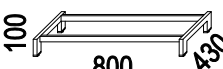

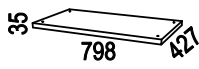
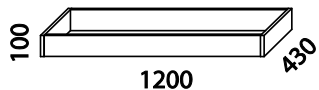
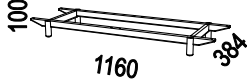
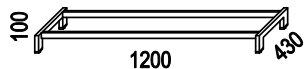

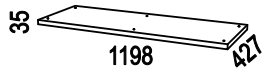
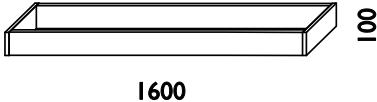
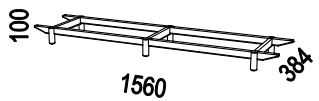
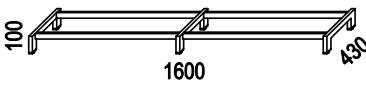

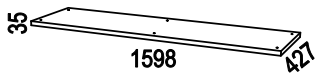
Illustration	Description	Article number	Material	EUR
<p><b>BASES</b></p> <p>• For basic units with depth 430 mm. • For additional product information; please see <a href="http://www.horreds.se">www.horreds.se</a></p> <p><b>MÖBELFAKTA</b></p> <p><u>Veneer group 1:</u> Birch (05) Oak (03) Ash (06)</p> <p><u>Veneer group 2:</u> White pigmented Oak (30) White pigmented Ash (10) Black stained Ash (86) Dark stained Ash (76)</p>				
<b>WIDTH 800 MM:</b>				
	Base 800x100x430 mm	57 31 <b>70310</b> 57 xx <b>70310</b> 57 xx <b>70310</b>	White dir.lam. Veneer group 1 Veneer group 2	119 137 137
	Leg base, solid wood, height 100 mm.	57 03 <b>70340</b> 57 06 <b>70340</b> 57 xx <b>70340</b>	Oak Ash Veneer group 2	315 315 315
	Leg base 800x100x430 mm, steel	57 31 <b>70330</b> 57 37 <b>70330</b>	White Black	144 144
	Castors. Height 100 mm. For 800 mm wide storage (4 castors of which 2 lockable)	<b>39 08 28</b>	Grey/zink	66
	Base plate with small adjustable feet, 798x35x427 mm	57 31 <b>70381</b> 57 xx <b>70381</b> 57 xx <b>70381</b>	White dir.lam. Veneer group 1 Veneer group 2	63 96 96
	Clamping knobs (4 pieces)	57 00 <b>04-19</b>		23

Illustration	Description	Article number	Material	EUR
<b>WIDTH 1200 MM:</b>				
	Base 1200x100x430 mm	57 31 <b>70510</b> 57 xx <b>70510</b> 57 xx <b>70510</b>	White dir.lam. Veneer group 1 Veneer group 2	130 168 168
	Leg base, solid wood, height 100 mm.	57 03 <b>70540</b> 57 06 <b>70540</b> 57 xx <b>70540</b>	Oak Ash Veneer group 2	377 377 377
	Leg base 1200x100x430 mm, steel	57 31 <b>70530</b> 57 37 <b>70530</b>	White Blacke	161 161
	Castors. Height 100 mm. to 1600 mm wide storage (5 castors of which 2 lockable)	<b>39 08 28-1</b>	Grey/zink	84
	Base plate with small adjustable feet, 1198x35x427 mm	57 31 <b>70581</b> 57 xx <b>70581</b> 57 xx <b>70581</b>	White dir.lam. Veneer group 1 Veneer group 2	92 109 109
	Clamping knobs (6 pieces)	57 00 <b>06-19</b>		28
<b>WIDTH 1600 MM:</b>				
	Base 1600x100x430 mm	57 31 <b>70710</b> 57 xx <b>70710</b> 57 xx <b>70710</b>	White dir.lam. Veneer group 1 Veneer group 2	136 211 211
	Leg base, solid wood, height 100 mm.	57 03 <b>70740</b> 57 06 <b>70740</b> 57 xx <b>70740</b>	Oak Ash Veneer group 2	483 483 483
	Leg base 1600x100x430 mm, steel	57 31 <b>70730</b> 57 37 <b>70730</b>	White Black	187 187
	Castors. Height 100 mm. to 1600 mm wide storage (6 castors of which 3 lockable)	<b>39 08 28-2</b>	Grey/zink	103
	Base plate with small adjustable feet, 1598x35x427 mm	57 31 <b>70781</b> 57 xx <b>70781</b> 57 xx <b>70781</b>	White dir.lam. Veneer group 1 Veneer group 2	99 121 121
	Clamping knobs (6 pieces)	57 00 <b>06-19</b>		28

Description	Article number	Material	EUR
-------------	----------------	----------	-----

**Biblio** Design: Anderssen & Voll

**Biblio** SLIDING DOORS



- Sliding doors in lacquered or veneered MDF
- Handles in veneered steel
- Fronts in optional NCS: delivery time 6 weeks.
- Including lock with 2 keys
- For additional product information please see [www.horreds.se](http://www.horreds.se)

Note! Price is for sliding doors only.

- Basic unit and base to be ordered separately.

**Material:**

**Veneer group 1:**

Oak (03)

Ash (06)

**Veneer group 2:**

White pigmented Oak (30)

White pigmented Ash (10)

Black stained Ash (86)

Dark stained Ash (76)

**White laquer:**

NCS S0300-N (31)

**Handles:**

**03** Oak

**06** Ash

**30** White pigmented oak

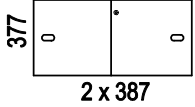
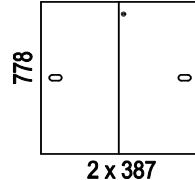
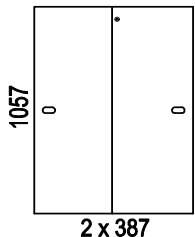
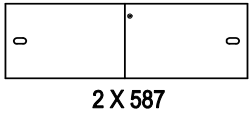
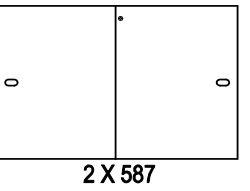
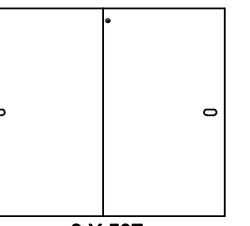
**10** White pigmented ash

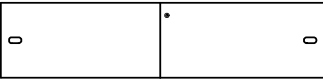
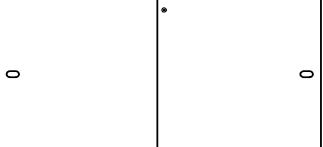
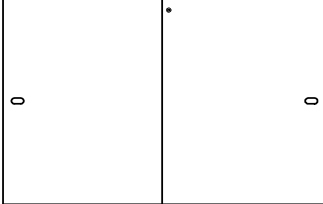
**86** Black stained ash

**76** Dark stained ash

**31** White (RAL 9016)



Description	Article number	Material	EUR		
<b>FOR STORAGE WIDTH 800 MM:</b>					
 <p>377 0 0 2 x 387</p>	Biblio sliding doors 1xA4-height. Fit on basic unit 800x420x430 mm (art 71310)	64 31xx <b>713481A</b> White direct laminate 64 xxxx <b>713481A</b> Veneer group 1 64 xxxx <b>713481A</b> Veneer group 2 64 99xx <b>713481A</b> Optional NCS	538 634 634 773		
	 <p>778 0 0 2 x 387</p>	Biblio sliding doors 2xA4-height. Fit on basic unit 1200x821x430 mm (art 72510)	64 31xx <b>723481A</b> White direct laminate 64 xxxx <b>723481A</b> Veneer group 1 64 xxxx <b>723481A</b> Veneer group 2 64 99xx <b>723481A</b> Optional NCS	557 654 654 793	
		 <p>1057 0 0 2 x 387</p>	Biblio sliding doors 3xA4-height. Fit on basic unit 800x1100x430 mm (art 73310)	64 31xx <b>733481A</b> White direct laminate 64 xxxx <b>733481A</b> Veneer group 1 64 xxxx <b>733481A</b> Veneer group 2 64 99xx <b>733481A</b> Optional NCS	576 672 672 812
			<b>FOR STORAGE WIDTH 1200 MM:</b>		
 <p>377 0 0 2 X 587</p>			Biblio sliding doors 1xA4-height. Fit on basic unit 1200x420x430 mm (art 71510)	64 31xx <b>715481A</b> White direct laminate 64 xxxx <b>715481A</b> Veneer group 1 64 xxxx <b>715481A</b> Veneer group 2 64 99xx <b>715481A</b> Optional NCS	544 640 640 780
	 <p>778 0 0 2 X 587</p>		Biblio sliding doors 2xA4-height. fit on basic unit 1200x821x430 mm (art 72510)	64 31xx <b>725481A</b> White direct laminate 64 xxxx <b>725481A</b> Veneer group 1 64 xxxx <b>725481A</b> Veneer group 2 64 99xx <b>725481A</b> Optional NCS	583 679 679 818
		 <p>1057 0 0 2 X 587</p>	Biblio sliding doors 3xA4-height. Fit on basic unit 1200x1100x430 mm (art 73510 och 73512)	64 31xx <b>735481A</b> White direct laminate 64 xxxx <b>735481A</b> Veneer group 1 64 xxxx <b>735481A</b> Veneer group 2 64 99xx <b>735481A</b> Optional NCS	608 704 704 844

Description	Article number	Material	EUR
<b>FOR STORAGE WIDTH 1600 MM:</b>			
<p>377</p>  <p style="text-align: center;">2 X 791</p>	<p>Biblio sliding doors 1xA4-height. Fit on basic unit 1600x420x430 mm (art 71710)</p>	<p>64 31xx <b>717481A</b> 64 xxxx <b>717481A</b> 64 xxxx <b>717481A</b> 64 99xx <b>717481A</b></p>	<p>White direct laminate 576 Veneer group 1 672 Veneer group 2 672 Optional NCS 812</p>
<p>778</p>  <p style="text-align: center;">2 X 791</p>	<p>Biblio sliding doors 2xA4-height. Fit on basic unit 1600x821x430 mm (art 72710)</p>	<p>64 31xx <b>727481A</b> 64 xxxx <b>727481A</b> 64 xxxx <b>727481A</b> 64 99xx <b>727481A</b></p>	<p>White direct laminate 621 Veneer group 1 791 Veneer group 2 791 Optional NCS 857</p>
<p>1057</p>  <p style="text-align: center;">2 X 791</p>	<p>Biblio sliding doors 3xA4-height. Fit on basic unit 1600x1100x430 mm (art 73710 och 73712)</p>	<p>64 31xx <b>737481A</b> 64 xxxx <b>737481A</b> 64 xxxx <b>737481A</b> 64 99xx <b>737481A</b></p>	<p>White direct laminate 669 Veneer group 1 826 Veneer group 2 826 Optional NCS 905</p>

Description	Article number	Material	EUR
-------------	----------------	----------	-----

**Nomono** Design: Fredrik Mattson

**Nomono** SLIDING DOORS



- Sliding doors in lacquered or veneered MDF
- Handles in lacquered steel sheet
- Fronts in optional NCS: delivery time 6 weeks.
- Including lock with 2 keys
- For additional product information please see [www.horreds.se](http://www.horreds.se)

Note! Price is for sliding doors only.

- Basic unit and base to be ordered separately.

**Material:**

**Veneer group 1:**

- Birch (05)
- Oak (03)
- Ash (06)

**Veneer group 2:**

- White pigmented Oak (30)
- White pigmented Ash (10)
- Black stained Ash (86)
- Dark stained Ash (76)

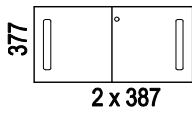
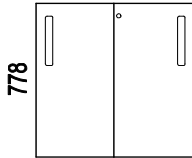
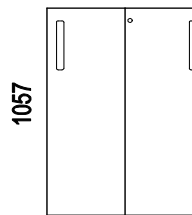

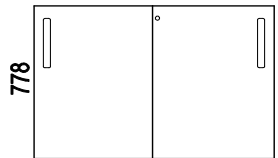
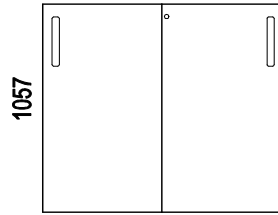
**White laquer:**

- NCS S0300-N (31)

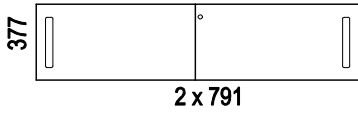
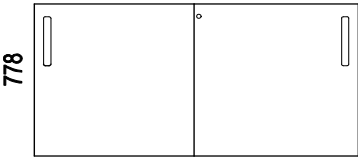
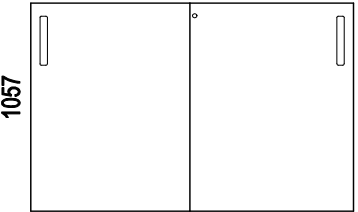
**Colour handles / Closest NCS**

- 31** White S0300-N
- 37** Black S9000-N
- 32** Yellow S1070-Y
- 36** Green S2570-G30Y
- 33** Red S1580-Y80R
- 35** Turq.Blue S540-B30G
- 42** Orange S1080-Y50R
- xx** \*Elmosoft Light Brown 54035  
\* additional cost € 70



Description	Article number	Material	EUR
<b>FOR STORAGE WIDTH 800 MM:</b>			
 <p>377 2 x 387</p>	Nomono sliding doors 1xA4-height. Fit on basic unit 800x420x430 mm (art 71310)	53 31xx <b>713381A</b> White laquer	508
		53 xxxx <b>713381A</b> Veneer group 1	603
		53 xxxx <b>713381A</b> Veneer group 2	603
		53 99xx <b>713381A</b> Optional NCS	740
 <p>778 2 x 387</p>	Nomono sliding doors 2xA4-height. Fit on basic unit 800x821x430 mm (art 72510)	53 31xx <b>723381A</b> White laquer	528
		53 xxxx <b>723381A</b> Veneer group 1	622
		53 xxxx <b>723381A</b> Veneer group 2	622
		53 99xx <b>723381A</b> Optional NCS	759
 <p>1057 2 x 387</p>	Nomono sliding doors 3xA4-height. Fit on basic unit 800x1100x430 mm (art 73310)	53 31xx <b>733381A</b> White laquer	546
		53 xxxx <b>733381A</b> Veneer group 1	641
		53 xxxx <b>733381A</b> Veneer group 2	641
		53 99xx <b>733381A</b> Optional NCS	778
<b>FOR STORAGE WIDTH 1200 MM:</b>			
 <p>377 2 x 587</p>	Nomono sliding doors 1xA4-height. Fit on basic unit 1200x420x430 mm (art 71510)	53 31xx <b>715381A</b> White laquer	515
		53 xxxx <b>715381A</b> Veneer group 1	609
		53 xxxx <b>715381A</b> Veneer group 2	609
		53 99xx <b>715381A</b> Optional NCS	746
 <p>778 2 x 587</p>	Nomono sliding doors 2xA4-height. fit on basic unit 1200x821x430 mm (art 72510)	53 31xx <b>725381A</b> White laquer	553
		53 xxxx <b>725381A</b> Veneer group 1	647
		53 xxxx <b>725381A</b> Veneer group 2	647
		53 99xx <b>725381A</b> Optional NCS	784
 <p>1057 2 x 587</p>	Nomono sliding doors 3xA4-height. Fit on basic unit 1200x1100x430 mm (art 73510 och 73512)	53 31xx <b>735381A</b> White laquer	578
		53 xxxx <b>735381A</b> Veneer group 1	672
		53 xxxx <b>735381A</b> Veneer group 2	672
		53 99xx <b>735381A</b> Optional NCS	809



Description	Article number	Material	EUR
<b>FOR STORAGE WIDTH 1600 MM:</b>			
 <p>377 2 x 791</p>	<p>Nomono sliding doors 1xA4-height. Fit on basic unit 1600x420x430 mm (art 71710)</p>	<p>53 31xx <b>717381A</b> 53 xxxx <b>717381A</b> 53 xxxx <b>717381A</b> 53 99xx <b>717381A</b></p>	<p>White laquer 546 Veneer group 1 641 Veneer group 2 641 Optional NCS 778</p>
 <p>778 2 x 791</p>	<p>Nomono sliding doors 2xA4-height. Fit on basic unit 1600x821x430 mm (art 72710)</p>	<p>53 31xx <b>727381A</b> 53 xxxx <b>727381A</b> 53 xxxx <b>727381A</b> 53 99xx <b>727381A</b></p>	<p>White laquer 591 Veneer group 1 757 Veneer group 2 757 Optional NCS 822</p>
 <p>1057 2 x 791</p>	<p>Nomono sliding doors 3xA4-height. Fit on basic unit 1600x1100x430 mm (art 73710 och 73712)</p>	<p>53 31xx <b>737381A</b> 53 xxxx <b>737381A</b> 53 xxxx <b>737381A</b> 53 99xx <b>737381A</b></p>	<p>White laquer 638 Veneer group 1 791 Veneer group 2 791 Optional NCS 869</p>

Description	Article number	Material	EUR
-------------	----------------	----------	-----

**VX**

**VX SLIDING DOORS**



- Sliding doors in white direct laminated particle board or veneered MDF
- Steel handle
- Fronts in optional NCS (lacquered MDF): delivery time 6 weeks
- Including lock with 2 keys
- For additional product information please see [www.horreds.se](http://www.horreds.se)

Note! Price is for sliding doors only.

- Basic unit and base be ordered separately.

**Material:**

**Veneer group 1:**

Birch (05)

Oak (03)

Ash (06)

**Veneer group 2:**

White pigmented Oak (30)

White pigmented Ash (10)

Black stained Ash (86)

Dark stained Ash (76)

**White direct laminate:**

NCS S0300-N (31)

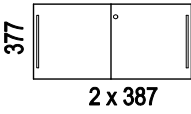
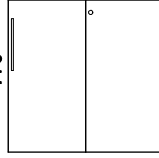
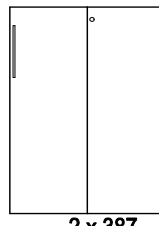
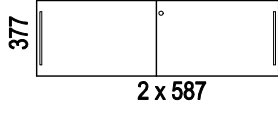
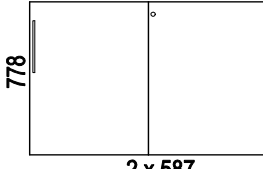
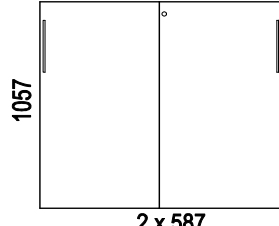
**Colour handles**

**31** White

**37** Black

**17** Stainless steel look



Description	Article number	Material	EUR	
<b>FOR STORAGE WIDTH 800 MM:</b>				
 <p>377 2 x 387</p>	VX sliding doors 1xA4-height. Fit on basic unit 800x420x430 mm (art 71310)	34 31xx <b>713481A</b>	White direct laminate	274
		34 xxxx <b>713481A</b>	Veneer group 1	482
		34 xxxx <b>713481A</b>	Veneer group 2	482
		34 99xx <b>713481A</b>	Optional NCS	505
 <p>778 2 x 387</p>	VX sliding doors 2xA4-height. Fit on basic unit 800x821x430 mm (art 72510)	34 31xx <b>723481A</b>	White direct laminate	289
		34 xxxx <b>723481A</b>	Veneer group 1	500
		34 xxxx <b>723481A</b>	Veneer group 2	500
		34 99xx <b>723481A</b>	Optional NCS	521
 <p>1057 2 x 387</p>	VX sliding doors 3xA4-height. Fit on basic unit 800x1100x430 mm (art 73310)	34 31xx <b>733481A</b>	White direct laminate	302
		34 xxxx <b>733481A</b>	Veneer group 1	519
		34 xxxx <b>733481A</b>	Veneer group 2	519
		34 99xx <b>733481A</b>	Optional NCS	533
<b>FOR STORAGE WIDTH 1200 MM:</b>				
 <p>377 2 x 587</p>	VX sliding doors 1xA4-height. Fit on basic unit 1200x420x430 mm (art 71510)	34 31xx <b>715481A</b>	White direct laminate	280
		34 xxxx <b>715481A</b>	Veneer group 1	488
		34 xxxx <b>715481A</b>	Veneer group 2	488
		34 99xx <b>715481A</b>	Optional NCS	512
 <p>778 2 x 587</p>	VX sliding doors 2xA4-height. fit on basic unit 1200x821x430 mm (art 72510)	34 31xx <b>725481A</b>	White direct laminate	305
		34 xxxx <b>725481A</b>	Veneer group 1	524
		34 xxxx <b>725481A</b>	Veneer group 2	524
		34 99xx <b>725481A</b>	Optional NCS	535
 <p>1057 2 x 587</p>	VX sliding doors 3xA4-height. Fit on basic unit 1200x1100x430 mm (art 73510 och 73512)	34 31xx <b>735481A</b>	White direct laminate	323
		34 xxxx <b>735481A</b>	Veneer group 1	549
		34 xxxx <b>735481A</b>	Veneer group 2	549
		34 99xx <b>735481A</b>	Optional NCS	554

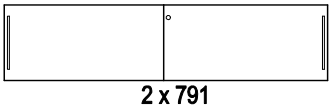
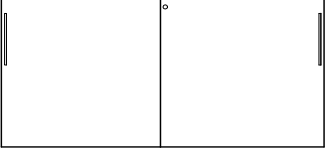
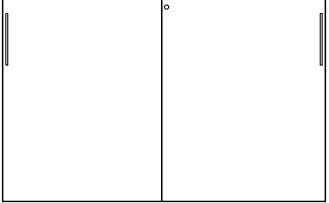
Description	Article number	Material	EUR
<b>FOR STORAGE WIDTH 1600 MM:</b>			
 <p>377 2 x 791</p>	<p>VX sliding doors 1xA4-height. Fit on basic unit 1600x420x430 mm (art 71710)</p>	<p>34 31xx <b>717481A</b> 34 <b>717481A</b> 34 <b>717481A</b> 34 <b>717481A</b></p>	<p>White direct laminate 295 Veneer group 1 519 Veneer group 2 519 Optional NCS 527</p>
 <p>778 2 x 791</p>	<p>VX sliding doors 2xA4-height. Fit on basic unit 1600x821x430 mm (art 72710)</p>	<p>34 31xx <b>727481A</b> 34 xxxx <b>727481A</b> 34 xxxx <b>727481A</b> 34 99xx <b>727481A</b></p>	<p>White direct laminate 323 Veneer group 1 630 Veneer group 2 630 Optional NCS 554</p>
 <p>1057 2 x 791</p>	<p>VX sliding doors 3xA4-height. Fit on basic unit 1600x1100x430 mm (art 73710 och 73712)</p>	<p>34 31xx <b>737481A</b> 34 xxxx <b>737481A</b> 34 xxxx <b>737481A</b> 34 99xx <b>737481A</b></p>	<p>White direct laminate 359 Veneer group 1 664 Veneer group 2 664 Optional NCS 590</p>

Illustration	Description	Article number	Material	EUR
<b>Siglo</b> Design: Henrik Schulz				
	<p><b>Siglo I STORAGE</b></p> <ul style="list-style-type: none"> <li>• Basic unit in direct laminated alt. veneered particle board</li> <li>• Doors in direct laminate alt. veneered MDF</li> <li>• Back in melamine</li> <li>• Works also as a room divider</li> <li>• Stationary shelves</li> <li>• Clamping knobs as standard. Wooden base as option</li> <li>• For additional product information; please see <a href="http://www.horreds.se">www.horreds.se</a></li> </ul> <p><u>Material:</u></p> <p><b>Veneer group 1:</b>                      Birch (05)                      Oak (03)                      Ash (06)</p> <p><b>Veneer group 2:</b>                      Black stained Ash (86)                      Dark stained Ash (76)                      White pigmented Oak (30)                      White pigmented Ash (10)</p> <p><b>White direct laminate:</b>                      Closest NCS: S0300-N</p> <p><u>Handles standard:</u></p> <p>31 White plastic                      37 Black plastic</p> <p><u>Handles optional:</u></p> <p>16 Brass                      17 Stainless</p> <p><u>Options:</u></p> <ul style="list-style-type: none"> <li>• Handles in brass or stainless steel: additional fee € 269.</li> <li>• Doors in optional NCS: additional fee € 249. Delivery time 6 weeks.</li> </ul>			
<b>WIDTH 800 MM:</b>			Unit / doors	
	Unit 800x420x430 mm (art 71310) including sliding doors (art 713081A) and clamping knobs (art 600004-19).	60 3131xx <b>S1A1</b> 60 31xxxx <b>S1A1</b> 60 31xxxx <b>S1A1</b> 60 xx31xx <b>S1A1</b> 60 xx31xx <b>S1A1</b> 60 xxxxxx <b>S1A1</b> 60 xxxxxx <b>S1A1</b>	White/white White/veneer gr 1 White/veneer gr 2 Veneer gr 1 / White Veneer gr 2 / White Veneer/veneer gr 1 Veneer/veneer gr 2	785 1 018 1 018 1 046 1 046 1 297 1 297
	Unit 800x821x430 mm (art 72310) including sliding doors (art 723081A) and clamping knobs (art 600004-19).	60 3131xx <b>S1A2</b> 60 31xxxx <b>S1A2</b> 60 31xxxx <b>S1A2</b> 60 xx31xx <b>S1A2</b> 60 xx31xx <b>S1A2</b> 60 xxxxxx <b>S1A2</b> 60 xxxxxx <b>S1A2</b>	White/white White/veneer gr 1 White/veneer gr 2 Veneer gr 1 / White Veneer gr 2 / White Veneer/veneer gr 1 Veneer/veneer gr 2	913 1 149 1 149 1 275 1 275 1 530 1 530

Illustration	Description	Article number	Material	EUR
<p>1100 800 430 1057 2 x 387</p>	Unit 800x1100x430 mm (art 73310) including sliding doors (art 733081A) and clamping knobs (art 600004-19).	60 3131xx <b>S1A3</b>	White/white	1 009
		60 31xxxx <b>S1A3</b>	White/veneer gr 1	1 253
		60 31xxxx <b>S1A3</b>	White/veneer gr 2	1 253
		60 xx31xx <b>S1A3</b>	Veneer gr 1 / White	1 623
		60 xx31xx <b>S1A3</b>	Veneer gr 2 / White	1 623
		60 xxxxxx <b>S1A3</b>	Veneer/veneer gr 1	1 885
		60 xxxxxx <b>S1A3</b>	Veneer/veneer gr 2	1 885
<p>100 800 430</p>	Add. fee for base 800x100x430 mm instead of clamping knobs	60 31 <b>70310</b>	White direct lam.	117
		60 xx <b>70310</b>	Veneer group 1	129
		60 xx <b>70310</b>	Veneer group 2	129
<b>WIDTH 1200 MM:</b>				
<p>420 1200 430 377 2 x 587</p>	Unit 1200x420x430 mm (art 71510) including sliding doors (art 715081A) and clamping knobs (art 600006-19).	60 3131xx <b>S1B1</b>	White/white	891
		60 31xxxx <b>S1B1</b>	White/veneer gr 1	1 124
		60 31xxxx <b>S1B1</b>	White/veneer gr 2	1 124
		60 xx31xx <b>S1B1</b>	Veneer gr 1 / White	1 280
		60 xx31xx <b>S1B1</b>	Veneer gr 2 / White	1 280
		60 xxxxxx <b>S1B1</b>	Veneer/veneer gr 1	1 531
		60 xxxxxx <b>S1B1</b>	Veneer/veneer gr 2	1 531
<p>821 1200 430 778 2 x 587</p>	Unit 1200x821x430 mm (art 72510) including sliding doors (art 725081A) and clamping knobs (art 600006-19).	60 3131xx <b>S1B2</b>	White/white	1 090
		60 31xxxx <b>S1B2</b>	White/veneer gr 1	1 337
		60 31xxxx <b>S1B2</b>	White/veneer gr 2	1 337
		60 xx31xx <b>S1B2</b>	Veneer gr 1 / White	1 604
		60 xx31xx <b>S1B2</b>	Veneer gr 2 / White	1 604
		60 xxxxxx <b>S1B2</b>	Veneer/veneer gr 1	1 870
		60 xxxxxx <b>S1B2</b>	Veneer/veneer gr 2	1 870
<p>1100 1200 430 1057 2 x 587</p>	Unit 1200x1100x430 mm (art 73510) including sliding doors (art 735081A) and clamping knobs (art 600006-19).	60 3131xx <b>S1B3</b>	White/white	1 111
		60 31xxxx <b>S1B3</b>	White/veneer gr 1	1 371
		60 31xxxx <b>S1B3</b>	White/veneer gr 2	1 371
		60 xx31xx <b>S1B3</b>	Veneer gr 1 / White	1 687
		60 xx31xx <b>S1B3</b>	Veneer gr 2 / White	1 687
		60 xxxxxx <b>S1B3</b>	Veneer/veneer gr 1	1 967
		60 xxxxxx <b>S1B3</b>	Veneer/veneer gr 2	1 967

Illustration	Description	Article number	Material	EUR
	Unit 1200x1100x430 mm with wardrobe (art 73512) including sliding doors (art 735081A) and clamping knobs (art 600006-19).	60 3131xx <b>S1BG</b>	White/white	1 510
		60 31xxxx <b>S1BG</b>	White/veneer gr 1	1 770
		60 31xxxx <b>S1BG</b>	White/veneer gr 2	1 770
		60 xx31xx <b>S1BG</b>	Veneer gr 1 / White	2 009
		60 xx31xx <b>S1BG</b>	Veneer gr 2 / White	2 009
		60 xxxxxx <b>S1BG</b>	Veneer/veneer gr 1	2 290
		60 xxxxxx <b>S1BG</b>	Veneer/veneer gr 2	2 290
	Add. fee for base 1200x100x430 mm instead of clamping knobs	60 31 <b>70510</b>	White direct lam.	127
		60 xx <b>70510</b>	Veneer group 1	157
		60 xx <b>70510</b>	Veneer group 2	157
<b>WIDTH 1600 MM:</b>				
	Unit 1600x420x430 mm (art 71710) including sliding doors (art 717081A) and clamping knobs(art 600006-19).	60 3131xx <b>S1C1</b>	White/white	1 014
		60 31xxxx <b>S1C1</b>	White/veneer gr 1	1 264
		60 31xxxx <b>S1C1</b>	White/veneer gr 2	1 264
		60 xx31xx <b>S1C1</b>	Veneer gr 1 / White	1 463
		60 xx31xx <b>S1C1</b>	Veneer gr 2 / White	1 463
		60 xxxxxx <b>S1C1</b>	Veneer/veneer gr 1	1 732
		60 xxxxxx <b>S1C1</b>	Veneer/veneer gr 2	1 732
	Unit 1600x821x430 mm (art 72710) including sliding doors (art 727081A) and clamping knobs (art 600006-19).	60 3131xx <b>S1C2</b>	White/white	1 246
		60 31xxxx <b>S1C2</b>	White/veneer gr 1	1 502
		60 31xxxx <b>S1C2</b>	White/veneer gr 2	1 502
		60 xx31xx <b>S1C2</b>	Veneer gr 1 / White	1 871
		60 xx31xx <b>S1C2</b>	Veneer gr 2 / White	1 871
		60 xxxxxx <b>S1C2</b>	Veneer/veneer gr 1	2 147
		60 xxxxxx <b>S1C2</b>	Veneer/veneer gr 2	2 147

Illustration	Description	Article number	Material	EUR
	Unit 1600x1100x430 mm (art 73710) including sliding doors (art 737081A) and clamping knobs (art 600006-19).	60 3131xx <b>S1C3</b>	White/white	1 373
		60 31xxxx <b>S1C3</b>	White/veneer gr 1	1 715
		60 31xxxx <b>S1C3</b>	White/veneer gr 2	1 715
		60 xx31xx <b>S1C3</b>	Veneer gr 1 / White	2 040
		60 xx31xx <b>S1C3</b>	Veneer gr 2 / White	2 040
		60 xxxxxx <b>S1C3</b>	Veneer/veneer gr 1	2 407
		60 xxxxxx <b>S1C3</b>	Veneer/veneer gr 2	2 407
	Unit 1600x1100x430 mm with wardrobe (art 73712) including sliding doors (art 737081A) and clamping knobs (art 600006).	60 3131xx <b>S1CG</b>	White/white	1 615
		60 31xxxx <b>S1CG</b>	White/veneer gr 1	1 956
		60 31xxxx <b>S1CG</b>	White/veneer gr 2	1 956
		60 xx31xx <b>S1CG</b>	Veneer gr 1 / White	2 315
		60 xx31xx <b>S1CG</b>	Veneer gr 2 / White	2 315
		60 xxxxxx <b>S1CG</b>	Veneer/veneer gr 1	2 780
		60 xxxxxx <b>S1CG</b>	Veneer/veneer gr 2	2 780
	Add. fee for base 1600x100x430 mm instead of clamping knobs	60 31 <b>70710</b>	White direct lam.	134
		60 xx <b>70710</b>	Veneer group 1	201
		60 xx <b>70710</b>	Veneer group 2	201





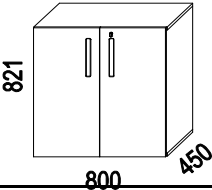
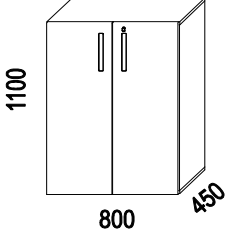
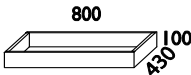
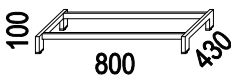
Illustration	Description	Article number	Material	EUR
<b>Nomono</b> Design: Fredrik Mattson				
<b>Nomono WITH HINGED DOORS</b> 				
	<ul style="list-style-type: none"> <li>Basic unit in direct laminated or veneered particleboard.</li> <li>Hinged doors in lacquered or veneered MDF. Opening 110°</li> <li>Including lock with 2 keys</li> <li>Back in melamine</li> <li>Stationary shelves</li> <li>Fronts in optiona NCS: delivery time 6 weeks</li> <li>Base not included, order separately</li> <li>For additional product information please see <a href="http://www.horred.se">www.horred.se</a></li> </ul>	<p><b>Material:</b></p> <p><b>Veneer group 1:</b>            Birch (05)            Oak (03)            Ash (06)</p> <p><b>Veneer group 2:</b>            White pigmented Oak (30)            White pigmented Ash (10)            Black stained Ash (86)            Black stained Ash (76)</p> <p><b>White direct laminate and laquer:</b>            NCS S0300-N (31)</p>		
		<p><b>Colour handles / Closest NCS</b></p> <p><b>31</b> White S0300-N  <b>37</b> Black S9000-N  <b>32</b> Yellow S1070-Y  <b>36</b> Green S2570-G30Y  <b>33</b> Red S1580-Y80R  <b>35</b> Turq.Blue S540-B30G  <b>42</b> Orange S1080-Y50R  <b>xx</b> * Elmosoft light brown 54035            * additional fee € 70.</p>		
	Storage 800x821x450 mm. 2 A4-height with hinged doors.  <i>Upcharge for doors in optional NCS</i>	53 31xx <b>72340</b> 53 xxxx <b>72340</b> 53 xxxx <b>72340</b>	White Veneer group 1 Veneer group 1	1 039 1 352 1 352 141
	Storage 800x1100x450 mm. 3 A4-height with hinged doors.  <i>Upcharge for doors in optional NCS</i>	53 31xx <b>73340</b> 53 xxxx <b>73340</b> 53 xxxx <b>73340</b>	White Veneer group 1 Veneer group 1	1 157 1 513 1 513 141
	Base 800x100x430 mm	57 31 <b>70310</b> 57 xxxx <b>70310</b> 57 xxxx <b>70310</b>	White Veneer group 1 Veneer group 1	119 137 137
	Leg base 800x100x430 mm, steel.	57 31 <b>70330</b> 57 37 <b>70330</b>	White Black	213 213



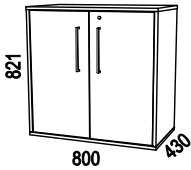
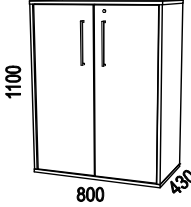
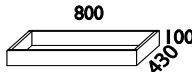
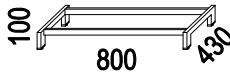




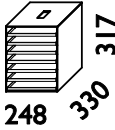
Illustration	Description	Article number	Material	EUR
<b>VX</b>				
<b>VX WITH HINGED DOORS</b>				
	<ul style="list-style-type: none"> <li>• Basic unit in direct laminated or veneered particleboard.</li> <li>• Hinged doors in direct laminated particle board or veneered MDF.</li> <li>• Including lock with 2 keys.</li> <li>• Back in melamine</li> <li>• Stationary shelves</li> <li>• Base not included, order separately</li> <li>• For more product information; please see <a href="http://www.horreds.se">www.horreds.se</a></li> </ul>			
	<p><b>Material:</b></p> <p>Veneer group 1: birch (05), oak (03), ash (06)</p> <p>Veneer group 2: black ash (86), dark ash (76), white oak (30), white ash (10)</p> <p>White direct laminatet: closest NCS S0300-N (31)</p>	<p><b>Colour handles</b></p> <p><b>31</b> White</p> <p><b>37</b> Black</p> <p><b>17</b> Stainless steel look</p>		
	<p>Storage 800x821x430 mm.</p> <p>2 A4-height with hinged doors.</p> <p><i>Upcharge for doors in optional NCS</i></p>	<p>34 31xx <b>72330</b></p> <p>34 xxxx <b>72330</b></p> <p>34 xxxx <b>72330</b></p>	<p>White direct laminate</p> <p>Veneer group 1</p> <p>Veneer group 2</p>	<p>705</p> <p>1 236</p> <p>1 236</p> <p>231</p>
	<p>Storage 800x1100x430 mm.</p> <p>3 A4-height with hinged doors.</p> <p><i>Upcharge for doors in optional NCS</i></p>	<p>34 31xx <b>73330</b></p> <p>34 xxxx <b>73330</b></p> <p>34 xxxx <b>73330</b></p>	<p>White direct laminate</p> <p>Veneer group 1</p> <p>Veneer group 2</p>	<p>754</p> <p>1 327</p> <p>1 327</p> <p>231</p>
	<p>Base 800x100x430 mm</p>	<p>57 31 <b>70310</b></p> <p>57 xx <b>70310</b></p> <p>57 xx <b>70310</b></p>	<p>White direct laminate</p> <p>Veneer group 1</p> <p>Veneer group 2</p>	<p>119</p> <p>137</p> <p>137</p>
	<p>Leg base 800x100x430 mm, steel.</p>	<p>57 31 <b>70330</b></p> <p>57 37 <b>70330</b></p>	<p>White</p> <p>Black</p>	<p>213</p> <p>213</p>
	<p>Castors. Height 100 mm.</p> <p>For 800 mm wide storage (4 castors of which 2 lockable).</p>	<p><b>39 08 28</b></p>	<p>Grey/zink</p>	<p>69</p>
	<p>Base plate with small adjustable feet</p> <p>798x35x427 mm</p>	<p>57 31 <b>70381</b></p> <p>57 xx <b>70381</b></p> <p>57 xx <b>70381</b></p>	<p>White direct laminate</p> <p>Veneer group 1</p> <p>Veneer group 2</p>	<p>63</p> <p>96</p> <p>96</p>
	<p>Clamping knobs (4 pieces)</p>	<p>57 00 <b>04</b></p>		<p>23</p>

Illustration	Description	Article number	Material	EUR
<p><b>ACCESSORIES TO STORAGE WITH DEPTH 43 CM</b></p> <p>• For more product information, see <a href="http://www.horreds.se">www.horreds.se</a></p>				
	<p>Insert in direct laminate with fronts in lacquer. 3 drawers. The top drawer is lockable.</p> <p><i>NB: does not fit VX width 80 cm with sliding doors.</i></p>	<p>57 31 <b>076</b></p> <p>57 3199 <b>076</b></p>	<p>White/white fronts</p> <p>White/opt.NCS fronts</p>	<p>353</p> <p>462</p>
	<p>Hanging file drawer, assembled on expansion racks.</p> <p>Fits in all units with slidings doors and in Nomono with hinged doors.</p>	<p>57 31 <b>03160</b></p>	<p>White</p>	<p>177</p>
	<p>C4-letter stack. Including 7 letter trays.</p>	<p>50 047 <b>134</b></p>	<p>Black</p>	<p>70</p>

**VX**

**VX Personal Storage**

- Basic unit in white chipboard with direct laminate coating.
- Doors in white direct laminate (chipboard) or lacquered and veneered (MDF).
- Movable shelves are ordered separately.
- Bases are ordererd separately
- Knobs/handles are ordered separately.
- Cover plates and top shelves as options.
- Must be anchored to the wall due to tipping risk.
- When ordering, specify whether doores should be right-hung (A, B) or left-hung (C, D). If nothing is specified, they are delivered right-hung.
- Doors with knob/handle with/without lock have soft-closed hinges, not push-open.
- Electronic locks: Mifare 13,56 MHz incl. battery.
- Battery replacement is recommended at 2-year intervals.
- Configurator to quickly see the price for your desired setup; see [www.horreds.se/Productst/Storage/Personal Stoage](http://www.horreds.se/Productst/Storage/Personal Stoage).



Basic units: White direct laminate, closest NCS S0300-N (31).




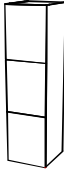


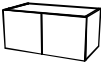
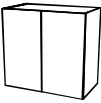
Doors white direct laminate: closest NCS S0300-N (31).


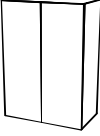
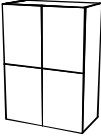
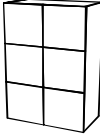

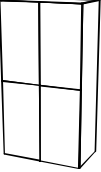
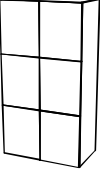
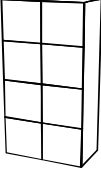
Doors Horreds optional NCS: see page 165





Doors customized optional NCS: Optional NCS (99).




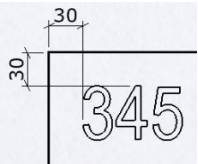

Doors veneer group 1: Oak (03), Ash (06), White oak (30), White Ash (10), Black Ash (86) Dark Ash (76), Stained ash, Burgundy (C8), Stained ash Conifer (D3), Stained ash Smokey Blue (D4).

		<u>Door model</u>	<u>Article number</u>	<u>White</u>	<u>Horreds NCS</u>	<u>Optional NCS</u>	<u>Veneer</u>
	Storage white direct laminate 432x432x477mm (BxHxD) incl 1 door.	Push-open, no lock	34 xx A00 <b>A11D</b>	24	26	29	32
		Electronic lock	34 xx zyy <b>A11A</b>	43	45	49	51
		Code lock	34 xx zyy <b>A11B</b>	30	32	35	38
		Cylinder lock	34 xx zyy <b>A11C</b>	28	30	34	36
	Storage white direct laminate 432x864x477mm (BxHxD) incl 1 door.	Push-open, no lock	34 xx A00 <b>A21D</b>	27	31	33	39
		Electronic lock	34 xx zyy <b>A21A</b>	46	50	53	59
		Code lock	34 xx zyy <b>A21B</b>	33	37	40	46
		Cylinder lock	34 xx zyy <b>A21C</b>	31	35	38	44
	Storage white direct laminate 432x864x477mm (BxHxD) incl 2 doors and 1 fixed shelf.	Push-open, no lock	34 xx A00 <b>A22D</b>	35	39	46	51
		Electronic lock	34 xx zyy <b>A22A</b>	74	78	85	90
		Code lock	34 xx zyy <b>A22B</b>	48	52	59	64
		Cylinder lock	34 xx zyy <b>A22C</b>	45	48	55	61
	Storage white direct laminate 432x1296x477mm (BxHxD) incl 1 dörr.	Push-open, no lock	34 xx A00 <b>A31D</b>	36	42	45	56
		Electronic lock	34 xx zyy <b>A31A</b>	55	61	65	76
		Code lock	34 xx zyy <b>A31B</b>	42	48	52	63
		Cylinder lock	34 xx zyy <b>A31C</b>	40	46	50	61
	Storage white direct laminate 432x1296x477mm (BxHxD) incl 2 doors and 1 fixed shelf.	Push-open, no lock	34 xx A00 <b>A32D</b>	40	46	52	65
		Electronic lock	34 xx zyy <b>A32A</b>	79	85	91	104
		Code lock	34 xx zyy <b>A32B</b>	53	59	65	77
		Cylinder lock	34 xx zyy <b>A32C</b>	50	56	62	74
	Storage white direct laminate 432x1296x477mm (BxHxD) incl 3 doors and 2 fixed shelves.	Push-open, no lock	34 xx A00 <b>A33D</b>	47	53	63	71
		Electronic lock	34 xx zyy <b>A33A</b>	105	111	122	130
		Code lock	34 xx zyy <b>A33B</b>	66	72	82	91
		Cylinder lock	34 xx zyy <b>A33C</b>	61	67	77	85

		<u>Door model</u>	<u>Article number</u>	<u>White</u>	<u>Horreds</u> <u>NCS</u>	<u>Optional</u> <u>NCS</u>	<u>Veneer</u>
	Wardrobe white direct lam. 432x1296x477mm (BxHxD) incl 1 door, clothes rail, 1 movable shelf and rubber mat.	Push-open, no lock Electronic lock Code lock Cylinder lock	34 xx A00 <b>A31DG</b> 34 xx zyy <b>A31AG</b> 34 xx zyy <b>A31BG</b> 34 xx zyy <b>A31CG</b>	511 681 567 552	565 734 620 606	596 766 652 637	689 859 745 730
	Storage white direct laminate 432x1728x477mm (BxHxD) incl 1 door and 1 fixed shelf.	Push-open, no lock Electronic lock Code lock Cylinder lock	34 xx A00 <b>A41D</b> 34 xx zyy <b>A41A</b> 34 xx zyy <b>A41B</b> 34 xx zyy <b>A41C</b>	360 530 416 401	432 602 488 473	468 638 524 509	553 722 608 593
	Storage white direct laminate 432x1728x477mm (BxHxD) incl 2 doors and 1 fixed shelf.	Push-open, no lock Electronic lock Code lock Cylinder lock	34 xx A00 <b>A42D</b> 34 xx zyy <b>A42A</b> 34 xx zyy <b>A42B</b> 34 xx zyy <b>A42C</b>	390 729 501 472	462 802 574 544	511 850 622 592	611 950 722 692
	Storage white direct laminate 432x1728x477mm (BxHxD) incl 3 doors and 2 fixed shelves.	Push-open, no lock Electronic lock Code lock Cylinder lock	34 xx A00 <b>A43D</b> 34 xx zyy <b>A43A</b> 34 xx zyy <b>A43B</b> 34 xx zyy <b>A43C</b>	453 961 620 575	520 1 029 687 642	610 1 118 777 732	715 1 224 882 837
	Storage white direct laminate 432x1728x477mm (BxHxD) incl 4 doors and 2 fixed shelves.	Push-open, no lock Electronic lock Code lock Cylinder lock	34 xx A00 <b>A44D</b> 34 xx zyy <b>A44A</b> 34 xx zyy <b>A44B</b> 34 xx zyy <b>A44C</b>	508 1 187 731 672	577 1 256 800 741	697 1 375 920 860	791 1 470 1 014 955
	Wardrobe white direct lam. 432x1728x477mm (BxHxD) incl 1 door, clothes rail, 1 movable shelf and rubber mat.	Push-open, no lock Electronic lock Code lock Cylinder lock	34 xx A00 <b>A41DG</b> 34 xx zyy <b>A41AG</b> 34 xx zyy <b>A41BG</b> 34 xx zyy <b>A41CG</b>	570 740 626 611	643 813 699 684	679 848 734 719	763 933 819 804
	Storage white direct laminate 864x432x477mm (BxHxD) incl 2 doors.	Push-open, no lock Electronic lock Code lock Cylinder lock	34 xx A00 <b>B12D</b> 34 xx zyy <b>B12A</b> 34 xx zyy <b>B12B</b> 34 xx zyy <b>B12C</b>	356 695 467 438	390 730 502 472	450 790 562 532	497 837 609 579
	Storage white direct laminate 864x864x477mm (BxHxD) incl 2 doors..	Push-open, no lock Electronic lock Code lock Cylinder lock	34 xx A00 <b>B22D</b> 34 xx zyy <b>B22A</b> 34 xx zyy <b>B22B</b> 34 xx zyy <b>B22C</b>	402 741 513 484	474 814 586 556	523 862 634 604	623 962 734 704

		<u>Door model</u>	<u>Article number</u>	<u>White</u>	<u>Horreds</u> <u>NCS</u>	<u>Optional</u> <u>NCS</u>	<u>Veneer</u>
	Storage white direct laminate 864x864x477mm (BxHxD) incl 4 doors and 2 fixed shelf.	Push-open, no lock	34 xx A00 <b>B24D</b>	549	618	737	831
		Electronic lock	34 xx zyy <b>B24A</b>	1 227	1 296	1 416	1 510
		Code lock	34 xx zyy <b>B24B</b>	772	841	960	1 055
		Cylinder lock	34 xx zyy <b>B24C</b>	712	781	900	995
	Storage white direct laminate 864x1296x477mm (BxHxD) incl 2 doors.	Push-open, no lock	34 xx A00 <b>B32D</b>	520	627	690	876
		Electronic lock	34 xx zyy <b>B32A</b>	859	966	1 029	1 216
		Code lock	34 xx zyy <b>B32B</b>	631	738	802	988
		Cylinder lock	34 xx zyy <b>B32C</b>	601	708	772	958
	Storage white direct laminate 864x1296x477mm (BxHxD) incl 4 doors and 2 fixed shelf.	Push-open, no lock	34 xx A00 <b>B34D</b>	639	745	849	1 060
		Electronic lock	34 xx zyy <b>B34A</b>	1 318	1 424	1 527	1 739
		Code lock	34 xx zyy <b>B34B</b>	863	968	1 072	1 283
		Cylinder lock	34 xx zyy <b>B34C</b>	803	909	1 012	1 224
	Storage white direct laminate 864x1296x477mm (BxHxD) incl 6 doors and 4 fixed shelf.	Push-open, no lock	34 xx A00 <b>B36D</b>	758	861	1 041	1 182
		Electronic lock	34 xx zyy <b>B36A</b>	1 776	1 879	2 059	2 200
		Code lock	34 xx zyy <b>B36B</b>	1 093	1 196	1 375	1 517
		Cylinder lock	34 xx zyy <b>B36C</b>	1 003	1 106	1 286	1 427
	Storage white direct laminate 864x1728x477mm (BxHxD) incl 2 doors and 2 fixed shelves.	Push-open, no lock	34 xx A00 <b>B42D</b>	641	785	857	1 026
		Electronic lock	34 xx zyy <b>B42A</b>	980	1 125	1 196	1 365
		Code lock	34 xx zyy <b>B42B</b>	752	897	968	1 137
		Cylinder lock	34 xx zyy <b>B42C</b>	722	867	938	1 107
	Storage white direct laminate 864x1728x477mm (BxHxD) incl 4 doors and 2 fixed shelves.	Push-open, no lock	34 xx A00 <b>B44D</b>	698	770	939	1 139
		Electronic lock	34 xx zyy <b>B44A</b>	1 376	1 448	1 618	1 818
		Code lock	34 xx zyy <b>B44B</b>	921	993	1 162	1 362
		Cylinder lock	34 xx zyy <b>B44C</b>	861	933	1 102	1 302
	Storage white direct laminate 864x1728x477mm (BxHxD) incl 6 doors and 4 fixed shelves.	Push-open, no lock	34 xx A00 <b>B46D</b>	826	961	1 140	1 351
		Electronic lock	34 xx zyy <b>B46A</b>	1 844	1 979	2 158	2 369
		Code lock	34 xx zyy <b>B46B</b>	1 161	1 296	1 475	1 685
		Cylinder lock	34 xx zyy <b>B46C</b>	1 071	1 206	1 385	1 596
	Storage white direct laminate 864x1728x477mm (BxHxD) incl 8 doors and 6 fixed shelves.	Push-open, no lock	34 xx A00 <b>B48D</b>	946	1 084	1 324	1 512
		Electronic lock	34 xx zyy <b>B48A</b>	2 304	2 442	2 681	2 869
		Code lock	34 xx zyy <b>B48B</b>	1 393	1 531	1 770	1 959
		Cylinder lock	34 xx zyy <b>B48C</b>	1 273	1 411	1 650	1 839

BASES						
		Article number	White	Horreds	Optional	Veneer
				NCS	NCS	
	Single base in white direct laminate Selectable material in the front. 430x150x454mm, Incl. adjustable feet	34 xx <b>A10</b>	94	113	124	128
	Double base in white direct laminate Selectable material in the front. 862x150x454mm, Incl adjustable feet.	34 xx <b>A20</b>	102	123	135	143
KNOBS AND HANDLES						
			Prices per door			
	Knob, lettered, Ø17mm, height 28mm Available in black, stainless look and brass look.	Dxx	White	Black	Stainless	Brass
			(31)	(37)	(17)	(16)
			8	8	8	8
	Knob, Ø28mm, height 24mm Available in matte white, matte black, stainless look and brass look.	Cxx	White (31)	Black (37)	Stainless (17)	Brass (16)
			8	8	8	8
	Milled down handle, ø45mm, with backing handle plate. Not for doors in direct laminate.	Bxx		Horreds NCS	Optional NCS	Veneer
				38	43	49
ACCESSORIES						
	Movable shelf 400x448.5mm. For width 432mm.	34 xx <b>09449</b>	White dir.lam			
	Movable shelf 400x448.5mm. For width 864mm.	34 xx <b>09470</b>	25			
	Keyboard holder in felt. Inner meas.: W230/D35/H210/80 mm. Attach on inside door. NB: not in combination with the smallest door 432x432 mm.	34 98 <b>08327</b>	(Antracit)	55		
	Removable, shallow shelf 400x402mm. For unit width 432mm. Used in combination with keyboard holder only.	34 31 <b>09479</b>	25			
	Removable, shallow shelf 408x402mm. Till unit width 864mm. Used in combination with keyboard holder only.	34 31 <b>09481</b>	25			

		<u>Article number</u>	<u>White</u>	<u>Horreds NCS</u>	<u>Optional NCS</u>	<u>Veneer</u>
	Shoe shelf 432x270x477mm, including black, rifled rubber mat.	34 xx <b>A001</b>	177	244	304	481
	Shoe shelf 864x270x477mm, including black, rifled rubber mat.	34 xx <b>A002</b>	280	338	408	666
	Add-on module 840x195mm, depth 480mm. Including 2 st plastic plant containers á 170x790x140mm i	34 xx <b>A09480</b>	287	390	473	572
	Seat cushion: contact us for quotation.					
	Foiling numbers Arial 188pt Foil figures, not assembled, price per piece Foil figures, assembled, price per piece	34 37 <b>-F03</b> 34 37 <b>FM03</b>				Black 7 26
	Portable storage box incl pen tray L343/B223/H240 mm.	34 37 <b>06018</b>				51
	User card for electronic lock	<b>371781</b>				16
	Battery for electronic lock Flexlock. Replacment is recommended to be done at a 2 years interval. In order to have your Flexlock work optimally it is required to use this Flexlock battery.	<b>376691</b>				9



COVER PANEL TOP					
<p>• Thickness 19mm</p> <p>• Max length top panel is 5 x door width = 2160mm.</p> <p>For wider sietups than 5 x door width, the top panel is split.</p>					
			<u>Horreds</u> <u>NCS</u>	<u>Optional</u> <u>NCS</u>	<u>Veneer</u>
	Top panel, depth 485mm, price per door width		64	93	106
	Top panel, depth 967mm, price per door width		87	127	148
COVER PANEL SIDE					
<p>• Thickness 19mm</p>					
	Side panel, 419x482mm		64	93	106
	Side panel, 581x482mm		64	93	106
	Side panel, 851x482mm		129	187	213
	Side panel, 1013x482mm		129	187	213
	Side panel, 1283x482mm		193	280	319
	Side panel, 1445x482mm		193	280	319
	Side panel, 1715x482mm		257	373	426
	Side panel, 1877x482mm		257	373	426
	Side panel, 2147x482mm		289	420	479
	Side panel, 419x964mm		87	127	148
	Side panel, 581x964mm		87	127	148
	Side panel, 851x964mm		174	254	296
	Side panel, 1013x964mm		174	254	296
	Side panel, 1283x964mm		260	381	443
	Side panel, 1445x964mm		260	381	443
	Side panel, 1715x964mm		347	508	591
	Side panel, 1877x964mm		347	508	591
	Side panel, 2147x964mm		391	572	665



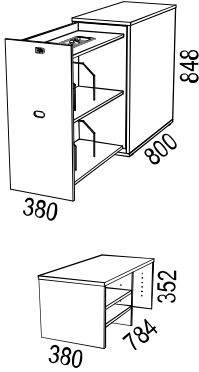
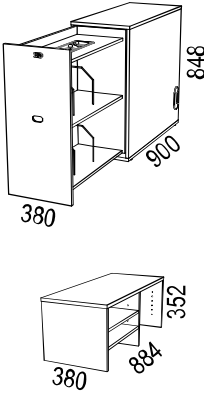
Illustration	Description	Article number	Material	EUR																																													
<p><b>Biblio</b> Design: Anderssen &amp; Voll</p>																																																	
	<p><b>Biblio Side Storage</b></p> <ul style="list-style-type: none"> <li>• Side storage in direct laminated or veneered particle board.</li> <li>• Doors in lacquered or veneered MDF with handles in veneered steel.</li> <li>• The inside is always white.</li> <li>• Stationary shelves.</li> <li>• With clamping knobs.</li> <li>• Max weight capacity: 50 kg.</li> <li>• Lockable.</li> <li>• Chose left or right; images below show units for placement on left side of desk</li> <li>• Can be easily rebuilt from left to right and vice versa.</li> <li>• <b>Note:</b> Dimensions and design changed from 2022.</li> <li>• For additional product information: please see <a href="http://www.horreds.se">www.horreds.se</a></li> </ul> <p><b>Material:</b>  <u>Veneer group 1:</u> Oak (03), Ash (06)  <u>Veneer group 2:</u> Blackst.ash (86), Darkst. ash (76),                      White pigm.oak(30), White pigm.ash (10)  <u>White direct laminate:</u> closest NCS S0300-N</p>		<p><b>Colour handles:</b>  <b>03</b> Oak  <b>06</b> Ash  <b>75</b> Black ash  <b>76</b> Dark ash  <b>30</b> White Oak  <b>10</b> White ash  <b>31</b> White (RAL 9016)</p>																																														
	<p>Biblio side storage height 2xA4.  <u>Depth 800 mm.</u> Incl.pen tray and brackets.</p> <p><i>Upcharge for front in optional NCS</i>  <i>Upcharge for veneered front to white unit</i></p> <p>Open top storage height 1xA4.</p> <p><i>Article numer for side storage prepared for top storage</i></p>	<table border="0"> <tr> <td>64</td> <td>3131xx</td> <td><b>11BV/H</b></td> <td>White</td> <td>1 125</td> </tr> <tr> <td>64</td> <td>xxxxxx</td> <td><b>11BV/H</b></td> <td>Veneer group 1</td> <td>1 707</td> </tr> <tr> <td>64</td> <td>xxxxxx</td> <td><b>11BV/H</b></td> <td>Veneer group 2</td> <td>1 707</td> </tr> <tr> <td></td> <td></td> <td></td> <td></td> <td>231</td> </tr> <tr> <td></td> <td></td> <td></td> <td></td> <td>231</td> </tr> <tr> <td>57</td> <td>31</td> <td><b>06400</b></td> <td>White</td> <td>318</td> </tr> <tr> <td>57</td> <td>xx</td> <td><b>06400</b></td> <td>Veneer group 1</td> <td>622</td> </tr> <tr> <td>57</td> <td>xx</td> <td><b>06400</b></td> <td>Veneer group 2</td> <td>622</td> </tr> <tr> <td>64</td> <td>xx</td> <td><b>11DV/H</b></td> <td></td> <td></td> </tr> </table>	64	3131xx	<b>11BV/H</b>	White	1 125	64	xxxxxx	<b>11BV/H</b>	Veneer group 1	1 707	64	xxxxxx	<b>11BV/H</b>	Veneer group 2	1 707					231					231	57	31	<b>06400</b>	White	318	57	xx	<b>06400</b>	Veneer group 1	622	57	xx	<b>06400</b>	Veneer group 2	622	64	xx	<b>11DV/H</b>				
64	3131xx	<b>11BV/H</b>	White	1 125																																													
64	xxxxxx	<b>11BV/H</b>	Veneer group 1	1 707																																													
64	xxxxxx	<b>11BV/H</b>	Veneer group 2	1 707																																													
				231																																													
				231																																													
57	31	<b>06400</b>	White	318																																													
57	xx	<b>06400</b>	Veneer group 1	622																																													
57	xx	<b>06400</b>	Veneer group 2	622																																													
64	xx	<b>11DV/H</b>																																															
	<p>Biblio side storage height 2xA4.  <u>Depth 900 mm.</u> Incl.pen tray and brackets.</p> <p><i>Upcharge for front in optional NCS</i>  <i>Upcharge for veneered front to white unit</i></p> <p>Open top storage height 1xA4.</p> <p><i>Article numer for side storage prepared for top storage</i></p>	<table border="0"> <tr> <td>64</td> <td>3131xx</td> <td><b>12BV/H</b></td> <td>White</td> <td>1 194</td> </tr> <tr> <td>64</td> <td>xxxxxx</td> <td><b>12BV/H</b></td> <td>Veneer group 1</td> <td>1 724</td> </tr> <tr> <td>64</td> <td>xxxxxx</td> <td><b>12BV/H</b></td> <td>Veneer group 2</td> <td>1 724</td> </tr> <tr> <td></td> <td></td> <td></td> <td></td> <td>231</td> </tr> <tr> <td></td> <td></td> <td></td> <td></td> <td>231</td> </tr> <tr> <td>57</td> <td>31</td> <td><b>06410</b></td> <td>White</td> <td>331</td> </tr> <tr> <td>57</td> <td>xx</td> <td><b>06410</b></td> <td>Veneer group 1</td> <td>644</td> </tr> <tr> <td>57</td> <td>xx</td> <td><b>06410</b></td> <td>Veneer group 2</td> <td>644</td> </tr> <tr> <td>64</td> <td>xx</td> <td><b>12DV/H</b></td> <td></td> <td></td> </tr> </table>	64	3131xx	<b>12BV/H</b>	White	1 194	64	xxxxxx	<b>12BV/H</b>	Veneer group 1	1 724	64	xxxxxx	<b>12BV/H</b>	Veneer group 2	1 724					231					231	57	31	<b>06410</b>	White	331	57	xx	<b>06410</b>	Veneer group 1	644	57	xx	<b>06410</b>	Veneer group 2	644	64	xx	<b>12DV/H</b>				
64	3131xx	<b>12BV/H</b>	White	1 194																																													
64	xxxxxx	<b>12BV/H</b>	Veneer group 1	1 724																																													
64	xxxxxx	<b>12BV/H</b>	Veneer group 2	1 724																																													
				231																																													
				231																																													
57	31	<b>06410</b>	White	331																																													
57	xx	<b>06410</b>	Veneer group 1	644																																													
57	xx	<b>06410</b>	Veneer group 2	644																																													
64	xx	<b>12DV/H</b>																																															

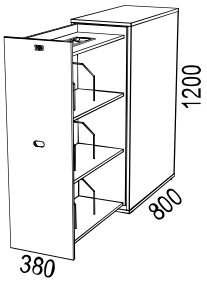
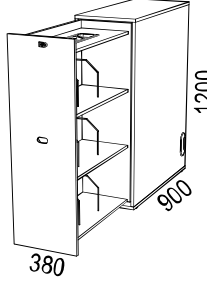
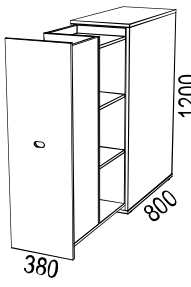
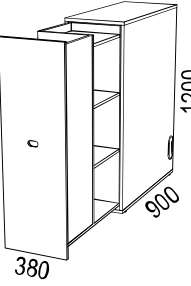
Illustration	Description	Article number	Material	EUR
	<p>Biblio side storage height 3xA4.  <u>Depth 800 mm.</u> Incl.pen tray and brackets.</p> <p><i>Upcharge for front in optional NCS</i>  <i>Upcharge for veneered front to white unit</i></p>	<p>64 3131xx <b>21BV/H</b>  64 xxxxxx <b>21BV/H</b>  64 xxxxxx <b>21BV/H</b></p>	<p>White  Veneer group 1  Veneer group 2</p>	<p>1 266  1 793  1 793  231  231</p>
	<p>Biblio side storage height 3xA4.  <u>Depth 900 mm.</u> Incl.pen tray and brackets.</p> <p><i>Upcharge for front in optional NCS</i>  <i>Upcharge for veneered front to white unit</i></p>	<p>64 3131xx <b>22BV/H</b>  64 xxxxxx <b>22BV/H</b>  64 xxxxxx <b>22BV/H</b></p>	<p>White  Veneer group 1  Veneer group 2</p>	<p>1 335  1 811  1 811  231  231</p>
<p><b>BIBLIO SPLIT</b></p> <ul style="list-style-type: none"> <li>• For 2 users. To be placed between two desks..</li> <li>• The inside is always white.</li> <li>• Stationary shelves.</li> <li>• Max weight capacity 50 kg.</li> <li>• Not lockable.</li> <li>• Inserts and Hanging file drawer do not fit in Split.</li> </ul>				
	<p>Biblio Split height 3xA4. <u>Depth 800 mm.</u></p> <p><i>Upcharge for front in optional NCS</i>  <i>Upcharge for veneered front to white unit</i></p>	<p>64 3131xx <b>21A</b>  64 xxxxxx <b>21A</b>  64 xxxxxx <b>21A</b></p>	<p>White  Veneer group 1  Veneer group 2</p>	<p>1 532  2 058  2 058  231  231</p>
	<p>Biblio Split height 3xA4. <u>Depth 900 mm.</u></p> <p><i>Upcharge for front in optional NCS</i>  <i>Upcharge for veneered front to white unit</i></p>	<p>64 3131xx <b>22A</b>  64 xxxxxx <b>22A</b>  64 xxxxxx <b>22A</b></p>	<p>White  Veneer group 1  Veneer group 2</p>	<p>1 600  2 076  2 076  231  231</p>



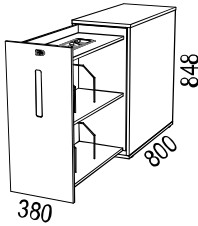
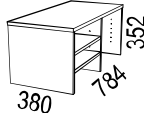
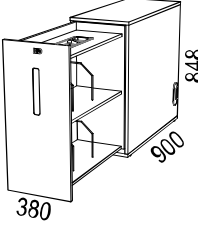
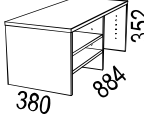
Illustration	Description	Article number	Material	EUR
<b>Nomono Design: Fredrik Mattson</b>				
	<p><b>Nomono Side Storage</b></p> <ul style="list-style-type: none"> <li>• Side storage in direct laminated or veneered particle board.</li> <li>• Doors in lacquered or veneered MDF with handles in lacquered steel sheet.</li> <li>• The inside is always white.</li> <li>• Stationary shelves.</li> <li>• With clamping knobs.</li> <li>• Max weight capacity: 50 kg.</li> <li>• Lockable.</li> <li>• Chose left or right; images below show units for placement on left side of desk</li> <li>• Can be easily rebuilt from left to right and vice versa.</li> <li>• <b>Note:</b> Dimensions and design changed from 2022.</li> <li>• For additional product information: please see <a href="http://www.horreds.se">www.horreds.se</a></li> </ul> <p><b>Material:</b></p> <p><u>Veneer group 1:</u> Oak (03), Ash (06)</p> <p><u>Veneer gr. 2:</u> Black ash (86), Dark Ash (76), White oak (30), White ash (10)</p> <p><u>White direct laminate:</u> Closest NCS 0300-N</p> <p>Handle in light brown Elmosoft 54035, upcharge € 70.</p>	 <p><b>Colour handles:</b></p> <p>31 White</p> <p>37 Black</p> <p>32 Yellow</p> <p>36 Green</p> <p>33 Red</p> <p>35 Blue</p> <p>42 Orange</p>	<p>Closest ncs:</p> <p>S 0300-N</p> <p>S 9000-N</p> <p>S 1070-Y</p> <p>S 2570-G30Y</p> <p>S 1580-Y80R</p> <p>S 0540-B30G</p> <p>S 1080-Y50R</p>	
 	<p>Nomono side storage height 2xA4. <u>Depth 800 mm.</u> Incl.pen tray and brackets.</p> <p><i>Upcharge for front in optional NCS</i> <i>Upcharge for veneered front to white unit</i></p> <p>Open top storage height 1xA4.</p> <p><i>Article numer for side storage prepared for top storage</i></p>	<p>52 3131xx <b>11BV/H</b></p> <p>52 xxxxxx <b>11BV/H</b></p> <p>52 xxxxxx <b>11BV/H</b></p> <p>57 31 <b>06400</b></p> <p>57 xx <b>06400</b></p> <p>57 xx <b>06400</b></p> <p>52 xx <b>11DV/H</b></p>	<p>White</p> <p>Veneer group 1</p> <p>Veneer group 2</p> <p>White</p> <p>Veneer group 1</p> <p>Veneer group 2</p>	<p>1 103</p> <p>1 685</p> <p>1 685</p> <p>231</p> <p>231</p> <p>318</p> <p>622</p> <p>622</p>
 	<p>Nomono side storage height 2xA4. <u>Depth 900 mm.</u> Incl.pen tray and brackets.</p> <p><i>Upcharge for front in optional NCS</i> <i>Upcharge for veneered front to white unit</i></p> <p>Open top storage height 1xA4.</p> <p><i>Article numer for side storage prepared for top storage</i></p>	<p>52 3131xx <b>12BV/H</b></p> <p>52 xxxxxx <b>12BV/H</b></p> <p>52 xxxxxx <b>12BV/H</b></p> <p>57 31 <b>06410</b></p> <p>57 xx <b>06410</b></p> <p>57 xx <b>06410</b></p> <p>52 xx <b>12DV/H</b></p>	<p>White</p> <p>Veneer group 1</p> <p>Veneer group 2</p> <p>White</p> <p>Veneer group 1</p> <p>Veneer group 2</p>	<p>1 172</p> <p>1 702</p> <p>1 702</p> <p>231</p> <p>231</p> <p>331</p> <p>644</p> <p>644</p>

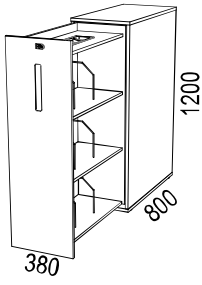
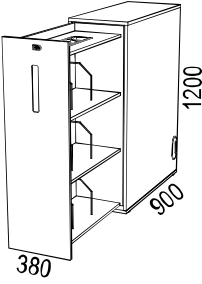
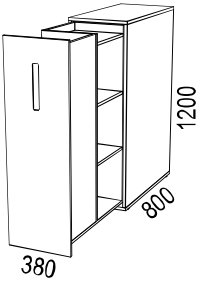
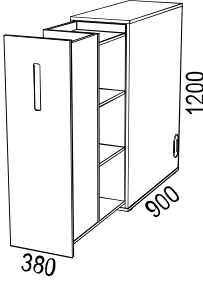
Illustration	Description	Article number	Material	EUR
	Nomono side storage height 3xA4. <u>Depth 800 mm.</u> Incl.pen tray and brackets.  <i>Upcharge for front in optional NCS</i> <i>Upcharge for veneered front to white unit</i>	52 3131xx <b>21BV/H</b>	White	1 244
		52 xxxxxx <b>21BV/H</b>	Veneer group 1	1 771
		52 xxxxxx <b>21BV/H</b>	Veneer group 2	1 771
				231
				231
	Nomono side storage height 3xA4. <u>Depth 900 mm.</u> Incl.pen tray and brackets.  <i>Upcharge for front in optional NCS</i> <i>Upcharge for veneered front to white unit</i>	52 3131xx <b>22BV/H</b>	White	1 312
		52 xxxxxx <b>22BV/H</b>	Veneer group 1	1 788
		52 xxxxxx <b>22BV/H</b>	Veneer group 2	1 788
				231
				231
<h3>NOMONO SPLIT</h3> <ul style="list-style-type: none"> <li>• For 2 users. To be placed between two desks..</li> <li>• The inside is always white.</li> <li>• Stationary shelves.</li> <li>• Max weight capacity 50 kg.</li> <li>• Not lockable.</li> <li>• Inserts and Hanging file drawer do not fit in Split.</li> </ul>				
	Nomono Split height 3xA4. <u>Depth 800 mm.</u>  <i>Upcharge for front in optional NCS</i> <i>Upcharge for veneered front to white unit</i>	52 3131xx <b>21A</b>	White	1 509
		52 xxxxxx <b>21A</b>	Veneer group 1	2 036
		52 xxxxxx <b>21A</b>	Veneer group 2	2 036
				231
				231
	Nomono Split height 3xA4. <u>Depth 900 mm.</u>  <i>Upcharge for front in optional NCS</i> <i>Upcharge for veneered front to white unit</i>	52 3131xx <b>22A</b>	White	1 578
		52 xxxxxx <b>22A</b>	Veneer group 1	2 054
		52 xxxxxx <b>22A</b>	Veneer group 2	2 054
				231
				231



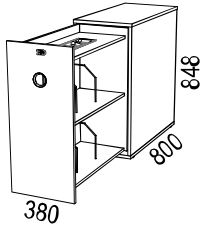
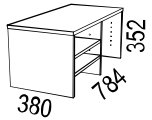
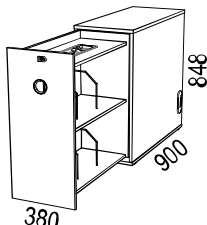
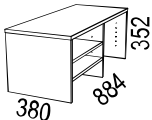
Illustration	Description	Article number	Material	EUR
<p><b>Siglo</b> Design: Henrik Schulz</p>				
	<p><b>Siglo Side Storage</b></p> <ul style="list-style-type: none"> <li>• Side storage in direct laminated or veneered particle board.</li> <li>• Round recess for handle, with ring and plate in white or black plastic as standard.</li> <li>• The inside is always white.</li> <li>• Stationary shelves.</li> <li>• With clamping knobs.</li> <li>• Max weight capacity: 50 kg.</li> <li>• Lockable.</li> <li>• Chose left or right; images below show units for placement on left side of desk</li> <li>• Can be easily rebuilt from left to right and vice versa.</li> <li>• For additional product information; please see <a href="http://www.horreds.se">www.horreds.se</a></li> </ul> <p><b>Material:</b>  <u>Veneer group 1:</u> Oak (03), Ash (06)  <u>Veneer group 2:</u> Blackst.ash (86), Darkst. ash (76),                      White pigm.oak(30), White pigm.ash (10)  <u>White direct laminate:</u> closest NCS S0300-N</p>		<p><b>Handles standard:</b>  <b>31</b> White plastic  <b>37</b> Black plastic</p> <p><b>Handles optional*:</b>  <b>16</b> Brass  <b>17</b> Stainless</p>	
 	<p>Siglo side storage height 2xA4.  <u>Depth 800 mm.</u> Incl.pen tray and brackets.</p> <p><i>Upcharge for front in optional NCS</i>  <i>Upcharge for veneered front to white unit</i></p> <p>Open top storage height 1xA4.</p> <p><i>Article numer for side storage prepared for top storage</i></p>	<p>60 3131xx <b>11BV/H</b>                      60 xxxxxx <b>11BV/H</b>                      60 xxxxxx <b>11BV/H</b></p> <p>60 31 <b>06400</b>                      60 xx <b>06400</b>                      60 xx <b>06400</b></p> <p>60 xx <b>11DV/H</b></p>	<p>White dir.lam.                      Veneer group 1                      Veneer group 2</p> <p>White dir.lam.                      Veneer group 1                      Veneer group 2</p>	<p>1 056                      1 612                      1 612                      259                      259                      356                      696                      696</p>
 	<p>Siglo side storage height 2xA4.  <u>Depth 900 mm.</u> Incl.pen tray and brackets.</p> <p><i>Upcharge for front in optional NCS</i>  <i>Upcharge for veneered front to white unit</i></p> <p>Open top storage height 1xA4.</p> <p><i>Article numer for side storage prepared for top storage</i></p>	<p>60 3131xx <b>12BV/H</b>                      60 xxxxxx <b>12BV/H</b>                      60 xxxxxx <b>12BV/H</b></p> <p>60 31 <b>06410</b>                      60 xx <b>06410</b>                      60 xx <b>06410</b></p> <p>60 xx <b>12DV/H</b></p>	<p>White dir.lam.                      Veneer group 1                      Veneer group 2</p> <p>White dir.lam.                      Veneer group 1                      Veneer group 2</p>	<p>1 129                      1 631                      1 631                      259                      259                      371                      721                      721</p>

Illustration	Description	Article number	Material	EUR
	Siglo side storage height 3xA4. <u>Depth 800 mm.</u> Incl.pen tray and brackets.  <i>Upcharge for front in optional NCS</i> <i>Upcharge for veneered front to white unit</i>	60 3131xx <b>21BV/H</b>	White dir.lam.	1 207
		60 xxxxxx <b>21BV/H</b>	Veneer group 1	1 796
		60 xxxxxx <b>21BV/H</b>	Veneer group 2	1 796
				259
				259
	Siglo side storage height 3xA4. <u>Depth 900 mm.</u> Incl.pen tray and brackets.  <i>Upcharge for front in optional NCS</i> <i>Upcharge for veneered front to white unit</i>	60 3131xx <b>22BV/H</b>	White dir.lam.	1 280
		60 xxxxxx <b>22BV/H</b>	Veneer group 1	1 815
		60 xxxxxx <b>22BV/H</b>	Veneer group 2	1 815
				259
				259
<h3>SIGLO SPLIT</h3> <ul style="list-style-type: none"> <li>• For 2 users. To be placed between two desks..</li> <li>• The inside is always white.</li> <li>• Stationary shelves.</li> <li>• Max weight capacity 50 kg.</li> <li>• Not lockable.</li> <li>• Inserts and Hanging file drawer do not fit in Split.</li> </ul>				
	Siglo Split height 3xA4. <u>Depth 800 mm.</u>  <i>Upcharge for front in optional NCS</i> <i>Upcharge for veneered front to white unit</i>	60 3131xx <b>21A</b>	White dir.lam.	1 489
		60 xxxxxx <b>21A</b>	Veneer group 1	2 079
		60 xxxxxx <b>21A</b>	Veneer group 2	2 079
				259
				259
	Siglo Split height 3xA4. <u>Depth 900 mm.</u>  <i>Upcharge for front in optional NCS</i> <i>Upcharge for veneered front to white unit</i>	60 3131xx <b>22A</b>	White dir.lam.	1 563
		60 xxxxxx <b>22A</b>	Veneer group 1	2 098
		60 xxxxxx <b>22A</b>	Veneer group 2	2 098
				259
				259

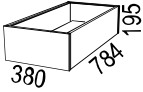
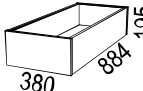
Illustration	Description	Article number	Material	EUR
<b>ACCESSORIES TO SIGLO SIDE STORAGE</b>				
	Add-on module in wood 380x784x195 mm incl. 1 plant container á 170x590x140 mm in recycled plastic	60 31 <b>06365-1</b> 60 xx <b>06365-1</b> 60 xx <b>06365-1</b>	White Veneer group 1 Veneer group 2	347 608 608
	Add-on module in wood 380x884x195 mm incl. 1 plant container á 170x790x140 mm in recycled plastic	60 31 <b>06365-2</b> 60 xx <b>06365-2</b> 60 xx <b>06365-2</b>	White Veneer group 1 Veneer group 2	347 608 608





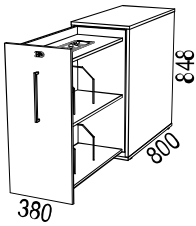
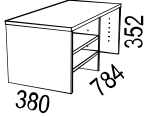
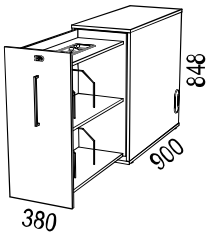
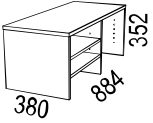
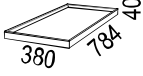
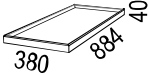

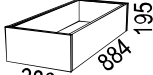


Illustration	Description	Article number	Material	EUR
<b>VX</b>				
<div style="display: flex; justify-content: space-between;"> <div style="width: 25%;">  </div> <div style="width: 50%;"> <h3>VX Side Storage</h3> <ul style="list-style-type: none"> <li>• Side storage in direct laminated or veneered particle board.</li> <li>• The inside is always white.</li> <li>• Stationary shelves.</li> <li>• With clamping knobs.</li> <li>• Max weight capacity: 50 kg.</li> <li>• Lockable.</li> <li>• Chose left or right; images below show units for placement on left side of desk</li> <li>• Can be easily rebuilt from left to right and vice versa.</li> <li>• For additional product information; please see <a href="http://www.horreds.se">www.horreds.se</a></li> </ul> </div> <div style="width: 20%; text-align: right;">  </div> </div> <div style="margin-top: 20px;"> <p><b>Material:</b></p> <p><u>Veneer group 1:</u> Birch (05), Oak (03), Ash (06)</p> <p><u>Veneer group 2:</u> Blackst.ash (86), Darkst. ash (76), White pigm.oak(30), White pigm.ash (10)</p> <p><u>White direct laminate:</u> closest NCS S0300-N</p> </div> <div style="margin-top: 20px;"> <p><b>Colour handles:</b></p> <p><b>31</b> White</p> <p><b>37</b> Black</p> <p><b>17</b> Stanless steel look</p> </div>				
 	<p>VX side storage height 2xA4. <u>Depth 800 mm.</u> Incl.pen tray and brackets.</p> <p><i>Upcharge for front in optional NCS</i> <i>Upcharge for veneered front to white unit</i></p> <p>Open top storage height 1xA4.</p> <p><i>Article numer for side storage prepared for top storage</i></p>	<p>34 3131xx <b>11BV/H</b></p> <p>34 xxxxxx <b>11BV/H</b></p> <p>34 xxxxxx <b>11BV/H</b></p> <p>57 31 <b>06400</b></p> <p>57 xx <b>06400</b></p> <p>57 xx <b>06400</b></p> <p>34 xx <b>11DV/H</b></p>	<p>White dir.lam.</p> <p>Veneer group 1</p> <p>Veneer group 2</p> <p>White dir.lam.</p> <p>Veneer group 1</p> <p>Veneer group 2</p>	<p>942</p> <p>1 438</p> <p>1 438</p> <p>231</p> <p>231</p> <p>318</p> <p>622</p> <p>622</p> 
 	<p>VX side storage height 2xA4. <u>Depth 900 mm.</u> Incl.pen tray and brackets.</p> <p><i>Upcharge for front in optional NCS</i> <i>Upcharge for veneered front to white unit</i></p> <p>Open top storage height 1xA4.</p> <p><i>Article numer for side storage prepared for top storage</i></p>	<p>34 3131xx <b>12BV/H</b></p> <p>34 xxxxxx <b>12BV/H</b></p> <p>34 xxxxxx <b>12BV/H</b></p> <p>57 31 <b>06410</b></p> <p>57 xx <b>06410</b></p> <p>57 xx <b>06410</b></p> <p>34 xx <b>12DV/H</b></p>	<p>White dir.lam.</p> <p>Veneer group 1</p> <p>Veneer group 2</p> <p>White dir.lam.</p> <p>Veneer group 1</p> <p>Veneer group 2</p>	<p>1 007</p> <p>1 455</p> <p>1 455</p> <p>231</p> <p>231</p> <p>331</p> <p>644</p> <p>644</p> 

Illustration	Description	Article number	Material	EUR
	VX side storage height 3xA4. <u>Depth 800 mm.</u> Incl.pen tray and brackets.  <i>Upcharge for front in optional NCS</i> <i>Upcharge for veneered front to white unit</i>	34 3131xx <b>21BV/H</b>	White dir.lam.	1 077
		34 xxxxxx <b>21BV/H</b>	Veneer group 1	1 602
		34 xxxxxx <b>21BV/H</b>	Veneer group 2	1 602
				231
				231
	VX side storage height 3xA4. <u>Depth 900 mm.</u> Incl.pen tray and brackets.  <i>Upcharge for front in optional NCS</i> <i>Upcharge for veneered front to white unit</i>	34 3131xx <b>22BV/H</b>	White dir.lam.	1 142
		34 xxxxxx <b>22BV/H</b>	Veneer group 1	1 619
		34 xxxxxx <b>22BV/H</b>	Veneer group 2	1 619
				231
				231
<b>VX SPLIT</b>				
<ul style="list-style-type: none"> <li>• For 2 users. To be placed between two desks..</li> <li>• The inside is always white.</li> <li>• Stationary shelves.</li> <li>• Max weight capacity 50 kg.</li> <li>• Not lockable.</li> <li>• Inserts and Hanging file drawer do not fit in Split.</li> </ul>				
	VX Split height 3xA4. <u>Depth 800 mm.</u>  <i>Upcharge for front in optional NCS</i> <i>Upcharge for veneered front to white unit</i>	34 3131xx <b>21A</b>	White dir.lam.	1 329
		34 xxxxxx <b>21A</b>	Veneer group 1	1 855
		34 xxxxxx <b>21A</b>	Veneer group 2	1 855
				231
				231
	VX Split height 3xA4. <u>Depth 900 mm.</u>  <i>Tillägg för lackad front i valfri NCS</i> <i>Tillägg för fanerad front (stomme i dir.lam)</i>	34 3131xx <b>22A</b>	White dir.lam.	1 394
		34 xxxxxx <b>22A</b>	Veneer group 1	1 871
		34 xxxxxx <b>22A</b>	Veneer group 2	1 871
				231
				231

Illustration	Description	Article number	Material	EUR
<b>ACCESSORIES TO SIDE STORAGE</b>				
	Tray 380x784x40 mm	64 xx <b>08750-080</b>	Veneer group 1	474
		64 xx <b>08750-080</b>	Veneer group 2	474
	Tray 380x884x40 mm	64 xx <b>08750-090</b>	Veneer group 1	474
		64 xx <b>08750-090</b>	Veneer group 2	474
	Add-on module in wood 380x784x195 mm incl. 1 plant container á 170x590x140 mm in recycled plastic	57 31 <b>06365-1</b>	White dir.lam.	311
		57 xx <b>06365-1</b>	Veneer gr 1	546
		57 xx <b>06365-1</b>	Veneer gr 1	546
	Add-on module in wood 380x884x195 mm incl. 1 plant container á 170x790x140 mm in recycled plastic	57 31 <b>06365-2</b>	White dir.lam.	311
		57 xx <b>06365-2</b>	Veneer gr 1	546
		57 xx <b>06365-2</b>	Veneer gr 1	546
	Hanging file drawer, assembled on expansion track <i>Does not fit in Split.</i>	57 31 <b>03160</b>	White	177
	Shallow insert in direct laminate with fronts in lacquer. 2 drawers. The top drawer incl a plastic pen drawer. <i>Does not fit in Split.</i>	57 31 <b>082</b>	White/White	292
		57 3199 <b>082</b>	White/Opt.NCS fronts	401

## MEETING TABLES INFO



Here is a presentation of our various stands for meeting tables.

Information regarding table tops, see next page.

### VX Conference

- Fixed T-leg stand in height 73 and 90 cm. White RAL9016 and black RAL 9005.
- Electric T-leg stand in height 70-120 cm for format MA, others formats 7. White RAL9016 and black RAL 9005.
- Tables in format MA (max. width 90 cm) is delivered with T-legs in dimension 80x50 mm with standard T-foot 70 cm. Solid foot as an option. Cable entries  $\varnothing$  80 mm and Powerdots max  $\varnothing$  60 mm are suitable for these tables.
- Tables in format MF, MG and MH (max. width 120 cm) are delivered with T-legs in dimension 80x50 mm with solid T-foot 70 cm.
- Tables in formats MG+ and MH+ (width 130-140 cm) are delivered with T-legs in dimension 70x70 mm with solid T-foot 90 cm.



### VX Project

- Square legs (7x7cm) in metal or solid wood (standard).
- Round legs ( $\varnothing$  10cm) in solid wood.
- Metal legs: White RAL9016, Black RAL9005 and 8 optional colours.
- Wooden legs: oak (03), ash (06), white oak (30), white ash (10), black ash (86), dark ash (76), Burgundy stained ash (C8), Conifer stained ash (D3), Smokey Blue stained ash (D4).
- Steel frame (white / black) or anodized aluminum frame.
- Table height 73 and 90 cm.
- Minimum width in standard version is 120 cm due to legroom and cable hole limitations. If you are interested in a table in width 100 or 90 cm; contact us for a proposal/quote.



### A-Frame stativ

Design: Anderssen & Voll

- A-stand in solid oak or ash with steel legs in white RAL9016 or Black RAL9005. Colour codes wooden legs: oak (03), ash (06), white oak (30), white ash (10), black ash (86), dark ash (76), Burgundy stained ash (C8), Conifer stained ash (D3), Smokey Blue stained ash (D4).
- Fits table sizes 1800-2400 x 900-1200 mm.
- Fixed table height 73 and 90 cm.
- Electric table height 70-120 cm for format MA, 73-110cm for format MG



**Table material:****High pressure laminate:**

White HPL 0754 (31)	Closest NCS: S0502-Y
Light grey HPL 0419 (2A)	S2002-Y
Light grey HPL 1365 (2B)	S2005-R80B
Medium grey HPL 1023 (2C)	S5500-N
Anthracite HPL 1397 (2D)	S7500-N
Black HPL 2253 (2E)	S9000-N

**Colours metal:**

1019 Grey Beige (3H)	Optional VX projekt
1024 Ochre yellow (3G)	Optional VX projekt
3007 Black red (3D)	Optional VX projekt
5008 Grey blue (3C)	Optional VX projekt
6009 Fir green (3L)	Optional VX projekt
6013 Reed green (3K)	Optional VX projekt
7039 Quartz grey (3J)	Optional VX projekt
7044 Silk grey (3A)	Optional VX projekt
9005 Jet black (37)	Standard VX / A-Frame
9016 Traffic white (31)	Standard VX / A-Frame

**Linoleum:**

4132 Ash	Closest NCS: 5502-G
4154 Burgundy	7010-R10B
4166 Charcoal	8502-B
4172 Mauve	7005-Y80R
4174 Conifer	8010-B90G
4175 Pebble	3502-Y
4176 Mushroom	2002-Y
4177 Vapour	2005-G10Y
4179 Smokey Blue	7010-R90B
4184 Olive	5010-G50Y

**Veneer group 1:**

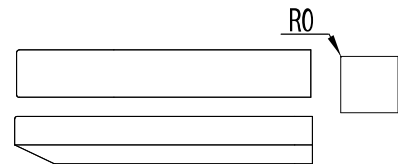
Birch* (05)
Oak (03)
Ash (06)

**Veneer group 2:**

White pigm. oak (30)**
Black stained ash (86)**
White pigmented ash (10)**
Dark stained ash (76)**
Burgundy stained ash (C8)**
Conifer stained ash (D3)**
Smokey Blue stain.ash (D4)**

\*=*not A-frame*\*\*=*not Henry***Bordsskivor:**  MÖBELFAKTA**VX**

- VX desk tops are made of 19 mm MDF with edging in matching colour.
- Option: chamfered edge
- Corner radius 0 mm.

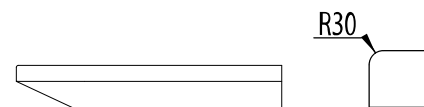
**VX radius 50**

- VX desk tops with rounded corners are made of 19 mm MDF with edging in matching colour
- Corner radius 50

**Fri**

Design: Bror Boije

- Fri desk tops are made of 19 mm MDF with chamfered, clear coated edge.
- Corner radius 30 mm.

**A-Frame**

Design: Anderssen &amp; Voll

- A-Frame desk tops are made of 19 mm MDF with edging in matching colour.
- Corner radius 0 mm.



- For more product information see [www.horreds.se](http://www.horreds.se)

## MEETING TABLES

# MA

Meeting tables within size 2000x900 mm.

VX T-legs are delivered with 700 mm standard foot, massive foot as option.

A-Frame is delivered with a leg stand in solid wood and legs in steel.

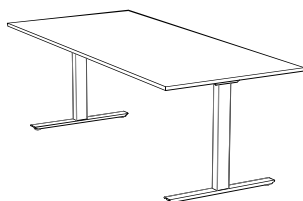
This format is not possible with a centered cable cover.

When ordering, state the desired table size, profile, material and colour and height of the stand.

Table top (excluding legs)	White HPL (31)	Optional HPL (39)	Linoleum (88)	Veneer group 1	Veneer group 2
<b>Series: Radius: Edge profile:</b>					
VX (3416) * 0 mm Straight / matching list	482	592	702	488	488
VX (3417) * 0 mm Chamfered / matching list	594	704	814	600	600
VX (3418) * 50 mm Straight / matching list	515	629	789	528	528
Fri (3513) 30 mm Chamfered / MDF	528	642	801	487	487
A-Frame (64) * 0mm Straight / matching list	516	633	752	523	523
* Upcharge for veneer edging on laminate	104	104			
* Upcharge for veneer edging on linoleum. Note: Only oak/ash nature and white pigmented. Not possible on stained tables.			104		
Possible cable entry: max ø 80 and Powerdot max ø 60 mm.					

Stativ (exklusive bordsskiva):	White (31) Black (37)	Optional colours	Oak (03) Ash (06)	Stain / White pigm..
<b>VX</b> T-legs fixed table height 73cm	602			
<b>VX</b> T-legs fixed table height 90cm	629			
<b>VX</b> T-legs electrical 61-126 cm	1 193			
Upcharge for massive feet	202			
<b>A-Frame</b> fixed table height 73cm			985	985
<b>A-Frame</b> fixed table height 90cm			1020	1020
<b>A-Frame</b> electrical 70-120cm			1917	1917

VX T-legs



Sizes:

Längd 1800-2000 mm

Bredd 900 mm

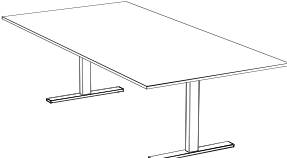

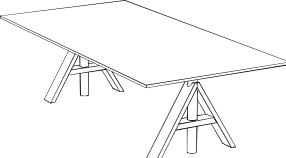
A-Frame

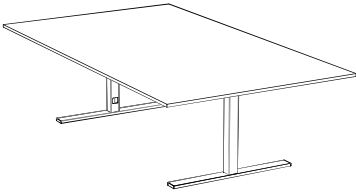
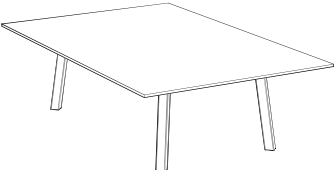


Sizes:

Längd 1800-2000 mm

Bredd 900 mm

MEETING TABLES								
<b>MF</b>		Meeting tables within size 2400x1200 mm.						
<p>VX T-legs are delivered with solid steel foot 700 mm.                      VX Project Stand is delivered with slanted legs in wood or metal.                      A-Frame is delivered with a leg stand in solid wood and legs in steel.                      When ordering, state the desired table size, profile, material and colour and height of the stand.</p>								
Table top (excluding legs)			White dir. laminate (31D)	White HPL (31)	Optional HPL (39)	Linoleum (88)	Veneer group 1	Veneer group 2
<b>Series:</b>	<b>Radius:</b>	<b>Edge profile:</b>						
VX (3416) *	0 mm	Straight / matching list	661	696	751	1 115	803	803
VX (3417) *	0 mm	Chamfered / matching list	697	732	787	1 151	849	849
VX (3418) *	50 mm	Straight / matching list	696	733	790	1 174	845	845
Fri (3513)	30 mm	Chamfered / MDF	734	771	828	1 212	893	893
A-Frame (64)	0mm	Straight / matching list	696	733	790	1 174	845	845
* Upcharge for veneer edging on laminate				104	104			
* Upcharge for veneer edging on linoleum. Note: Only oak/ash nature and white pigmented. Not possible on stained tables.						104		
Stand (excluding table top):					White (31) Black (37)	Optional colours	Oak (03) Ash (06)	Stain / White pigm..
<b>VX Conference</b> , 2xT-legs with solid 70cm foot, table height 73cm					886			
<b>VX Conference</b> , 2xT-legs with solid 70cm foot, table height 90cm					913			
<b>VX Conference</b> 2xT-legs electrical 73-110cm					1 519			
<b>VX Project</b> , 4xlegs, steel frame, table height 73cm					1 366	1 523	1 366	1 445
<b>VX Project</b> , 4xlegs, steel frame, table height 90cm					1 513	1 670	1 513	1 592
Upcharge for wooden legs with round profile							92	92
<b>A-Frame conference</b> , white / black legs, table height 73cm							1 194	1 194
<b>A-Frame conference</b> , white / black legs, table height 90cm							1 228	1 228
<b>A-frame conference</b> electrical 73-110cm							2 089	2 089
<b>VX Conference</b>			<b>VX Project</b>			<b>A-Frame</b>		
								
Sizes: Length 2000-2400 mm Width 900-1200 mm			Sizes: Length 2000-2400 mm Width 1200 mm			Sizes: Length 2000-2400 mm Width 900-1200 mm		

MEETING TABLES						
<h1>MF+</h1> Meeting tables within size 2400x1400 mm.						
VX Conference is delivered with solid steel foot 900 mm. Wiring through the leg possible. VX Project Stand is delivered with slanted legs in wood or metal. When ordering, state the desired table size, profile, material and colour and height of the stand.						
Table top (excluding legs)	White dir. laminate (31D)	White HPL (31)	Optional HPL (39)	Linoleum (88)	Veneer group 1	Veneer group 2
<b>Series:</b> <b>Radius:</b> <b>Edge profile:</b> VX (3416) *    0 mm    Straight / matching list VX (3417) *    0 mm    Chamfered / matching list VX (3418) *    50 mm    Straight / matching list Fri (3513)    30 mm    Chamfered / MDF A-Frame (64)    0mm    Straight / matching list	721	1 153		1 409	1 640	1 640
	757	1 189		1 445	1 687	1 687
	760	1 214		1 483	1 728	1 728
	797	1 252		1 521	1 775	1 775
		104				
* Upcharge for veneer edging on laminate				104		
* Upcharge for veneer edging on linoleum. Note: Only oak/ash nature and white pigmented. Not possible on stained tables.						
Stand (excluding table top):			White (31) Black (37)	Optional colours	Oak (03) Ash (06)	Stain / White pigm..
VX Conference, 2xT-legs with solid 90cm foot, table height 73cm			1 757			
VX Conference, 2xT-legs with solid 90cm foot, table height 90cm			1 859			
VX Conference 2xT-legs electrical 70-106cm			3 551			
VX Project, 4xlegs, steel frame, table height 73cm			1 366	1 523	1 366	1 445
VX Project, 4xlegs, steel frame, table height 90cm			1 513	1 670	1 513	1 592
Upcharge for wooden legs with round profile					92	92
<p><b>VX Conference</b></p>  <p>Sizes: Length 2000-2400 mm Width 1300-1400 mm</p>		<p><b>VX Project</b></p>  <p>Sizes: Length 2000-2400 mm Width 1300-1400 mm</p>				



**MEETING TABLES**

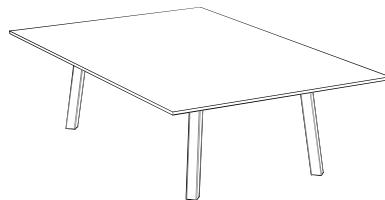
**MF++** Meeting tables within size 2400x1600 mm.

VX Project Stand is delivered with slanted legs in wood or metal.

When ordering, state the desired table size, profile, material and colour and height of the stand.

Table top (excluding legs)	White dir. laminate (31D)	White HPL (31)	Optional HPL (39)	Linoleum (88)	Veneer group 1	Veneer group 2
<b>Series:</b> VX (3416) * <b>Radius:</b> 0 mm <b>Edge profile:</b> Straight / matching list	982	1 522		1 915	1 828	1 828
* Upcharge for veneer edging on laminate		104				
* Upcharge for veneer edging on linoleum. Note: Only oak/ash nature and white pigmented. Not possible on stained tables.				104		
<b>Stand (excluding table top):</b>			White (31) Black (37)	Optional colours	Oak (03) Ash (06)	Stain / White pigm..
VX Project, 4xlegs, steel frame, table height 73cm			1 366	1 523	1 366	1 445
VX Project, 4xlegs, steel frame, table height 90cm			1 513	1 670	1 513	1 592
Upcharge for wooden legs with round profile					92	92

**VX Project**



Sizes:

Length 2000-2400 mm

Width 1500-1600 mm

**MEETING TABLES**

**MG**

2-piece Meeting tables within size 4800x1200

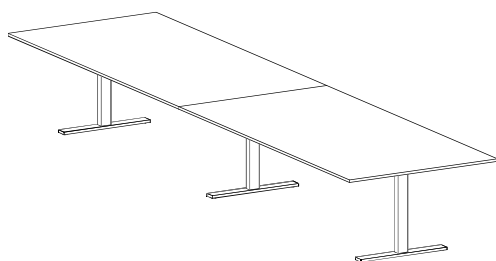
VX T-legs are delivered with solid steel foot 700 mm.

VX Project Stand is delivered with slanted legs in wood or metal.

When ordering, state the desired table size, profile, material and colour and height of the stand.

Table top (excluding legs)	White dir. laminate (31D)	White HPL (31)	Optional HPL (39)	Linoleum (88)	Veneer group 1	Veneer group 2
<b>Series: Radius: Edge profile:</b>						
VX (3416) * 0 mm Straight / matching list, 2 pcs	1 431	1 501	1 556	2 339	1 713	1 713
VX (3417) * 0 mm Chamfered / matching list, 2 pcs	1 503	1 574	1 628	2 411	1 806	1 806
VX (3418) * 50 mm Straight / matching list, 2 pcs	1 506	1 580	1 638	2 462	1 804	1 804
Fri (3513) 30 mm Chamfered / MDF, 2 pcs	1 582	1 656	1 713	2 538	1 901	1 901
* Upcharge for veneer edging on laminate		104	104			
* Upcharge for veneer edging on linoleum. Note: Only oak/ash nature and white pigmented. Not possible on stained tables.				104		
<b>Stand (excluding table top):</b>			White (31) Black (37)	Optional colours	Oak (03) Ash (06)	Stain / White pigm..
<b>VX Conference</b> , 3xT-legs with solid 70cm foot, table height 73cm			1 512			
<b>VX Conference</b> , 3xT-legs with solid 70cm foot, table height 90cm			1 553			
<b>VX Project</b> , 4xlegs, aluminium frame, table height 73cm			2 450	2 606	2 450	2 528
<b>VX Project</b> , 4xlegs, aluminium frame, table height 90cm			2 597	2 754	2 597	2 675
Upcharge for wooden legs with round profile					92	92
<b>VX Projekt</b> , 6xlegs steel frame, table height 73cm			2 297	2 531	2 297	2 414
<b>VX Projekt</b> , 6xlegs steel frame, table height 90cm			2 515	2 750	2 515	2 633
Upcharge for wooden legs with round profile					138	138

**VX Conference**

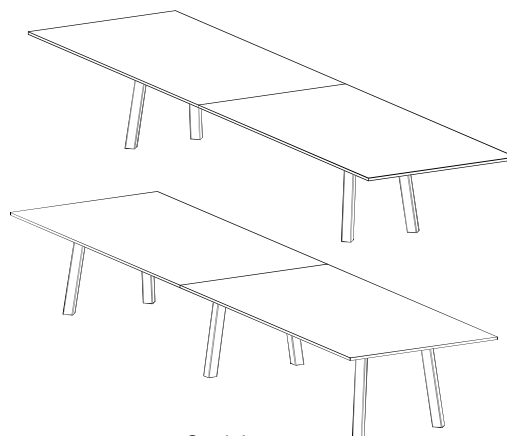


Storlekar:

Length max 4800 mm

Width 900-1200 mm

**VX Project**



Storlekar:

Length max 4800 mm

Width 1200 mm

**MEETING TABLES**

**MG+** 2-piece Meeting tables within size 4800x1400

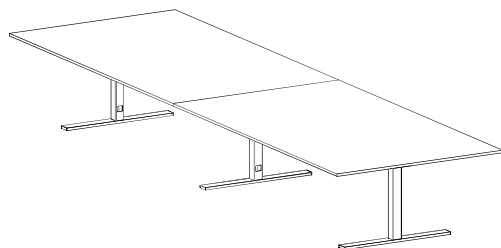
VX T-legs are delivered with solid steel foot 700 mm.

VX Project Stand is delivered with slanted legs in wood or metal.

When ordering, state the desired table size, profile, material and colour and height of the stand.

Table top (excluding legs)			White dir. laminate (31D)	White HPL (31)	Optional HPL (39)	Linoleum (88)	Veneer group 1	Veneer group 2
<b>Serie</b>	<b>Hörnradie</b>	<b>Kantprofil</b>						
VX (3416) *	0 mm	Straight / matching list, 2 pcs	1 552	2 415		2 927	3 389	3 389
VX (3417) *	0 mm	Chamfered / matching list, 2 pcs	1 623	2 488		2 999	3 482	3 482
VX (3418) *	50 mm	Straight / matching list, 2 pcs	1 633	2 543		3 081	3 586	3 586
Fri (3513)	30 mm	Chamfered / MDF, 2 pcs	1 709	2 618		3 157	3 665	3 665
* Upcharge for veneer edging on laminate				104				
* Upcharge for veneer edging on linoleum. Note: Only oak/ash nature and white pigmented. Not possible on stained tables.						104		0
<b>Stand (excluding table top):</b>					White (31) Black (37)	Optional colours	Oak (03) Ash (06)	Stain / White pigm..
<b>VX Conference</b> , 3xT-legs with solid 70cm foot, table height 73cm					2 883			
<b>VX Conference</b> , 3xT-legs with solid 70cm foot, table height 90cm					3 035			
<b>VX Project</b> , 4xlegs, aluminium frame, table height 73cm					2 450	2 606	2 450	2 528
<b>VX Project</b> , 4xlegs, aluminium frame, table height 90cm					2 597	2 754	2 597	2 675
Upcharge for wooden legs with round profile							92	92
<b>VX Projekt</b> , 6xlegs steel frame, table height 73cm					2 297	2 531	2 297	2 414
<b>VX Projekt</b> , 6xlegs steel frame, table height 90cm					2 515	2 750	2 515	2 633
Upcharge for wooden legs with round profile							138	138

**VX Conference**

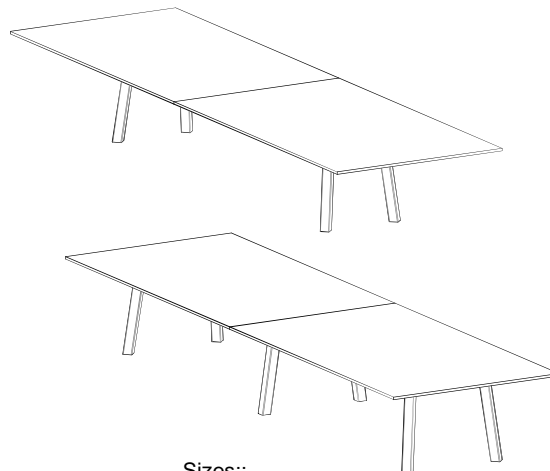


Sizes::

Length max 4800 mm

Width 1300-1400 mm

**VX Project**



Sizes::

Length max 4800 mm

**MEETING TABLES**

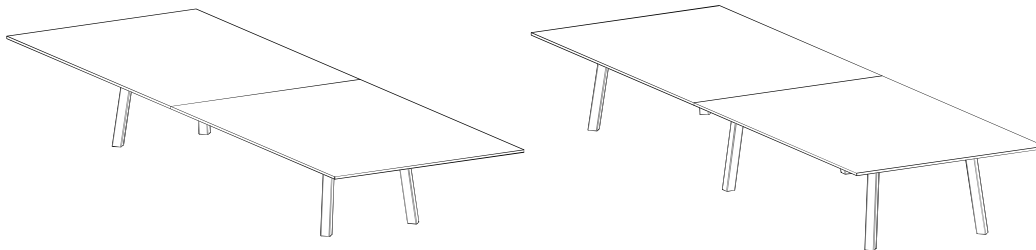
**MG++** 2-piece Meeting tables within size 4800x1600

VX Project Stand is delivered with slanted legs in wood or metal.

When ordering, state the desired table size, profile, material and colour and height of the stand.

Table top (excluding legs)	White dir. laminate (31D)	White HPL (31)	Optional HPL (39)	Linoleum (88)	Veneer group 1	Veneer group 2
<b>Series: Radius: Edge profile:</b> VX (3416) * 0 mm Straight / matching list, 2 pcs	2 073	3 165		3 950	3 765	3 765
* Upcharge for veneer edging on laminate		104				
* Upcharge for veneer edging on linoleum. Note: Only oak/ash nature and white pigmented. Not possible on stained tables.				104		
<b>Stand (excluding table top):</b>			White (31) Black (37)	Optional colours	Oak (03) Ash (06)	Stain / White pigm..
<b>VX Project</b> , 4xlegs, aluminium frame, table height 73cm			2 450	2 606	2 450	2 528
<b>VX Project</b> , 4xlegs, aluminium frame, table height 90cm			2 597	2 754	2 597	2 675
Upcharge for wooden legs with round profile					92	92
<b>VX Projekt</b> , 6xlegs steel frame, table height 73cm			2 297	2 531	2 297	2 414
<b>VX Projekt</b> , 6xlegs steel frame, table height 90cm			2 515	2 750	2 515	2 633
Upcharge for wooden legs with round profile					138	138

**VX Project**



Sizes:  
Length max 4800 mm  
Width 1500-1600 mm

**MEETING TABLES**

**MH**

3-piece Meeting tables within size 7200x1200

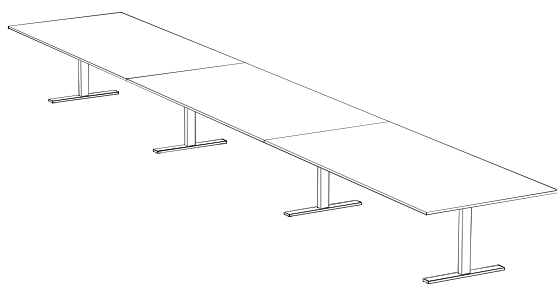
VX T-legs are delivered with solid steel foot 700 mm.

VX Project Stand is delivered with slanted legs in wood or metal.

When ordering, state the desired table size, profile, material and colour and height of the stand.

Table top (excluding legs)	White dir. laminate (31D)	White HPL (31)	Optional HPL (39)	Linoleum (88)	Veneer group 1	Veneer group 2
<b>Series: Radius: Edge profile:</b> VX (3416) * 0 mm Straight / matching list, 3 pcs VX (3417) * 0 mm Chamfered / matching list, 3 pcs VX (3418) * 50 mm Straight / matching list, 3 pcs Fri (3513) 30 mm Chamfered / MDF, 3 pcs	2 146	2 252	2 334	3 509	2 570	2 570
	2 254	2 360	2 442	3 617	2 710	2 710
	2 259	2 371	2 457	3 694	2 706	2 706
	2 373	2 485	2 570	3 808	2 852	2 852
* Upcharge for veneer edging on laminate		104	104			
* Upcharge for veneer edging on linoleum. Note: Only oak/ash nature and white pigmented. Not possible on stained tables.				104		
<b>Stand (excluding table top):</b>			White (31) Black (37)	Optional colours	Oak (03) Ash (06)	Stain / White pigm..
<b>VX Conference</b> , 4xT-legs with solid 70cm foot, table height 73cm			2 125			
<b>VX Project</b> , 6xlegs, aluminum frame, table height 73cm			3 531	3 765	3 531	3 648
Upcharge for wooden legs with round profile					138	138

**VX Conference**

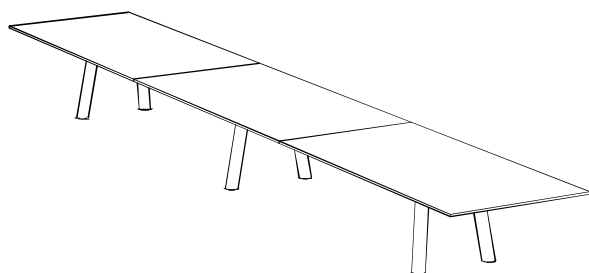


Sizes:

Length max 7200 mm

Width 1000-1200 mm

**VX Project**



Sizes:

Length max 7200 mm

Width 1200 mm

**MEETING TABLES**

**MH+**

3-piece Meeting tables within size 7200x1400

VX Conference is delivered with solid steel foot 900 mm. Wiring through the leg possible.

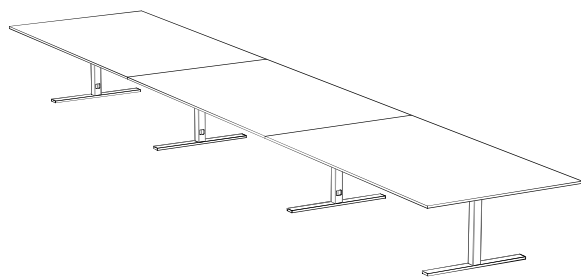
VX Project Stand is delivered with slanted legs in wood or metal.

When ordering, state the desired table size, profile, material and colour and height of the stand.

Table top (excluding legs)	White dir. laminate (31D)	White HPL (31)	Optional HPL (39)	Linoleum (88)	Veneer group 1	Veneer group 2
<b>Series: Radius: Edge profile:</b>						
VX (3416) * 0 mm Straight / matching list, 3 pcs	2 327	3 623		4 390	5 084	5 084
VX (3417) * 0 mm Chamfered / matching list, 3 pcs	2 435	3 731		4 499	5 223	5 223
VX (3418) * 50 mm Straight / matching list, 3 pcs	2 450	3 814		4 621	5 360	5 360
Fri (3513) 30 mm Chamfered / MDF, 3 pcs	2 564	3 928		4 735	5 498	5 498
* Upcharge for veneer edging on laminate		104				
* Upcharge for veneer edging on linoleum. Note: Only oak/ash nature and white pigmented. Not possible on stained tables.				104		

Stand (excluding table top):	White (31) Black (37)	Optional colours	Oak (03) Ash (06)	Stain / White pigm..
<b>VX Conference</b> , 4xT-legs with solid 90cm foot, table height 73cm	4 010			
<b>VX Project</b> , 6xlegs, aluminum frame, table height 73cm	3 531	3 765	3 531	3 648
Upcharge for wooden legs with round profile			138	138

**VX Conference**

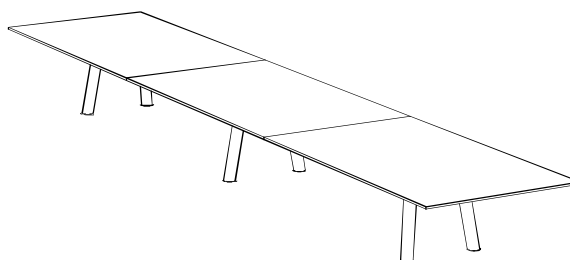


Sizes:

Length max 7200 mm

Width 1300-1400 mm

**VX Project**



Sizes:

Length max 7200 mm

Width 1300-1400 mm

**MEETING TABLES**

**MH++** 3-piece Meeting tables within size 7200x1600

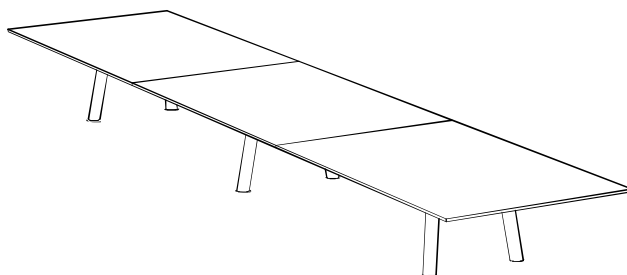
VX Project Stand is delivered with slanted legs in wood or metal.

When ordering, state the desired table size, profile, material and colour and height of the stand.

Table top (excluding legs)	White dir. laminate (31D)	White HPL (31)	Optional HPL (39)	Linoleum (88)	Veneer group 1	Veneer group 2
<b>Series:</b> VX (3416) * <b>Radius:</b> 0 mm <b>Edge profile:</b> Straight / matching list, 3 pcs * Upcharge for veneer edging on laminate * Upcharge for veneer edging on linoleum. Note: Only oak/ash nature and white pigmented. Not possible on stained tables.	3 163	4 807 104		5 985 104	5 701	5 701

Stand (excluding table top):	White (31) Black (37)	Optional colours	Oak (03) Ash (06)	Stain / White pigm..
VX Procekt, 6xlegs, aluminum frame, desk height 73cm	3 531	3 765	3 531	3 648
Upcharge for wooden legs with round profile			138	138

**VX Project**



Sizes:

Length max 7200 mm

Width 1500-1600 mm

**MEETING TABLES**

**Q**

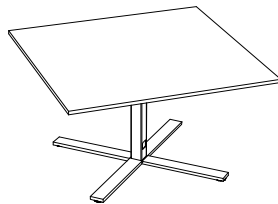
Square tables

VX Conference is delivered with a solid cross base. Wiring through the leg possible.  
When ordering, state the desired table size, profile, material and colour and height of the stand.

Table top (excluding legs)	White dir. laminate (31D)	White HPL (31)	Optional HPL (39)	Linoleum (88)	Veneer group 1	Veneer group 2
<b>Series: Radius: Edge profile:</b>						
VX (3416) * 0 mm Straight / matching list	368	387	477	477	458	458
VX (3417) * 0 mm Chamfered / matching list	474	500	589	589	570	570
VX (3418) * 50 mm Straight / matching list	514	541	666	666	640	640
Fri (3513) 30 mm Chamfered / MDF	504	531	654	654	627	627
* Upcharge for veneer edging on laminate		104	104			
* Upcharge for veneer edging on linoleum. Note: Only oak/ash nature and white pigmented. Not possible on stained tables.				104		

<b>VX Conference</b> Cross foot* in table height 730 mm for table tops sizes:	White (31) Black (37)
600X600-900x900 mm	445
Upcharge for stand in height 1060 mm	31

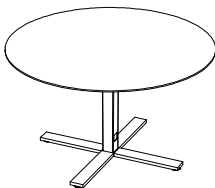
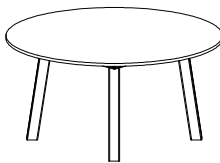
\* Outgoing product, sold only as long as stock lasts. Contact customer support for stock status.



Sizes (mm):

- 600x600
- 700x700
- 800x800
- 900x900



MEETING TABLES										
<b>R1</b> Round meeting tables max diameter 1400										
VX Conference is delivered with a solid cross base. Wiring through the leg possible.										
VX Project Stand is delivered with slanted legs in wood or metal.										
When ordering, state the desired table size, profile, material and colour and height of the stand.										
Series	Radius	Edge profile	White dir. laminate (31D)	White HPL (31)	Optional HPL (39)	Linoleum (88)	Veneer group 1	Veneer group 2		
Round table tops ø 600 - 900 mm (excluding legs)										
VX (3416) *	0 mm	Straight / matching list	368	387	477	477	458	458		
VX (3417) *	0 mm	Chamfered / matching list	474	500	589	589	570	570		
Fri (3513)	30 mm	Chamfered / MDF	504	531	654	654	627	627		
Round table tops ø 1000 - 1200 mm (excluding legs)										
VX (3416) *	0 mm	Straight / matching list	444	468	573	662	529	529		
VX (3417) *	0 mm	Chamfered / matching list	551	580	685	774	641	641		
Fri (3513)	30 mm	Chamfered / MDF	608	641	785	907	725	725		
Round table top ø 1400 mm (excluding legs)										
VX (3416) *	0 mm	Straight / matching list	721	1 153		1 409	1 640	1 640		
VX (3417) *	0 mm	Chamfered / matching list	757	1 189		1 445	1 687	1 687		
Fri (3513)	30 mm	Chamfered / MDF	797	1 252		1 521	1 775	1 775		
Option: cable lid 980										
* Upcharge for veneer edging on laminate				104						
* Upcharge for veneer edging on linoleum. Note: Only oak/ash nature and white pigmented. Not possible on stained tables.						104				
<b>VX Conference</b> Cross foot * in table height 730 mm for table tops sizes:			Vit (31)							
600-900 mm			Svart (37)							
Upcharge for stand in height 1060 mm			445							
			31							
* Utgående produkt, säljes endast så lång lagret räcker. Kontakta kundsupport för lagerstatus.										
<b>VX Project</b> 4xlegs with steel frame:			White (31) Black (37)	Optional colours	Oak (03) Ash (06)	Stain / White pigm..				
Desk height 730 mmm			1 366	1 523	1 366	1 445				
Desk height 900 mm			1 513	1 670	1 513	1 592				
Upcharge for wooden legs with round profile					92	92				
<b>VX Conference</b>			<b>VX Project</b>							
			Sizes (mm): Ø 600, 700, 800, 900.						Sizes (mm): Ø 1000, 1200, 1400.	

## MEETING TABLES

# R2

2-piece meeting tables max 2400x2400 mm

VX Project Stand is delivered with slanted legs in wood or metal.

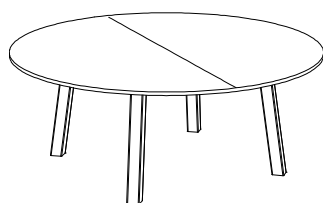
When ordering, state the desired table size, profile, material and colour and height of the stand.

No matching of veneer.

Round/square able tops ø 1500 - 2400 mm (excluding legs)	White dir. laminate (31D)	White HPL (31)	Optional HPL (39)	Linoleum (88)	Veneer group 1	Veneer group 2
<b>Serie Hörnradié Kantprofil</b>						
VX (3416) 0 mm Rak med matchande kantlist, 2 st	1 431	1 501	1 556	2 339	1 713	1 713
VX (3417) 0 mm Fasad med matchande kantlist, 2 st	1 503	1 574	1 628	2 411	1 806	1 806
Fri (3513) 30 mm Fasad MDF, 2 st	1 582	1 656	1 713	2 538	1 901	1 901
* Upcharge for veneer edging on laminate		104	104			
* Upcharge for veneer edging on linoleum. Note: Only oak/ash nature and white pigmented. Not possible on stained tables.				104		
Option: cable lid 980						

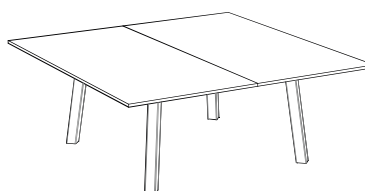
VX Project 4xlegs with steel frame (exck tabke top):	White (31) Black (37)	Optional colours	Oak (03) Ash (06)	Stain / White pigm
Table height 73 cm	1 366	1 523	1 366	1 445
Table height 90 cm	1 513	1 670	1 513	1 592
Upcharge for wooden legs with round profile			92	92

VX Project round table tops



Sizes (mm):  
Ø 1500, 1600, 1800, 2000, 2400.

VX Project square table tops



Sizes (mm):  
1500X1500, 1600x1600, 1800x1800, 2000x2000, 2400x2400.


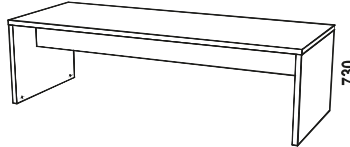
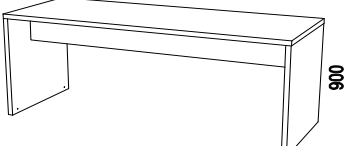
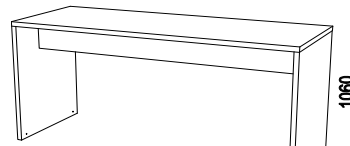
Illustration	Description	Article number	Material	EUR																								
<p><b>Nomono Conference</b> Design: Fredrik Mattson</p>																												
	<p><b>Nomono CONFERENCE TABLE</b></p> <ul style="list-style-type: none"> <li>Nomono conference is made of 38 mm particle board</li> <li>Radius 90 and straight edges with matching pp-list</li> <li>Material:                     <table border="0" data-bbox="534 369 1173 481"> <tr> <td>White HPL (31)</td> <td>Vitpigment (30)</td> <td>Burgundy stained ash (C8)</td> </tr> <tr> <td>Oak (03)</td> <td>White ash (10)</td> <td>Conifer stained ash (D3)</td> </tr> <tr> <td>Ash (06)</td> <td>Black ash (86)</td> <td>Smokey Blue stained ash (D4)</td> </tr> <tr> <td></td> <td>Dark ash (76)</td> <td></td> </tr> </table> </li> <li>Distance from edge of desk to middle frame:                     <ul style="list-style-type: none"> <li>Width 1100 = 420 mm</li> <li>Width 1000 = 370 mm</li> <li>Width 900 = 320 mm</li> <li>Width 800 = 270 mm</li> <li>Width 700 = 220 mm</li> </ul> </li> <li>Cable box Bibox and Powerdot PD14 och PD61 fits Nomono Conference.</li> <li>For more product information, please see <a href="http://www.horreds.se">www.horreds.se</a></li> </ul>				White HPL (31)	Vitpigment (30)	Burgundy stained ash (C8)	Oak (03)	White ash (10)	Conifer stained ash (D3)	Ash (06)	Black ash (86)	Smokey Blue stained ash (D4)		Dark ash (76)													
White HPL (31)	Vitpigment (30)	Burgundy stained ash (C8)																										
Oak (03)	White ash (10)	Conifer stained ash (D3)																										
Ash (06)	Black ash (86)	Smokey Blue stained ash (D4)																										
	Dark ash (76)																											
	<p><b>Nomono conference in height 720 mm</b> Available lengths: 2400, 2200, 2000, 1800 och 1600 mm.</p> <table border="0" data-bbox="518 840 1460 1164"> <tr> <td>Width 800 or 900 mm</td> <td>White HPL</td> <td>2 433</td> </tr> <tr> <td></td> <td>Oak / Ash</td> <td>2 915</td> </tr> <tr> <td></td> <td>Stained Ash</td> <td>2 915</td> </tr> <tr> <td></td> <td>White Oak / Ash</td> <td>2 915</td> </tr> <tr> <td>Width 1000 or 1100 mm</td> <td>White HPL</td> <td>2 975</td> </tr> <tr> <td></td> <td>Oak / Ash</td> <td>3 457</td> </tr> <tr> <td></td> <td>Stained Ash</td> <td>3 457</td> </tr> <tr> <td></td> <td>White Oak / Ash</td> <td>3 457</td> </tr> </table>				Width 800 or 900 mm	White HPL	2 433		Oak / Ash	2 915		Stained Ash	2 915		White Oak / Ash	2 915	Width 1000 or 1100 mm	White HPL	2 975		Oak / Ash	3 457		Stained Ash	3 457		White Oak / Ash	3 457
Width 800 or 900 mm	White HPL	2 433																										
	Oak / Ash	2 915																										
	Stained Ash	2 915																										
	White Oak / Ash	2 915																										
Width 1000 or 1100 mm	White HPL	2 975																										
	Oak / Ash	3 457																										
	Stained Ash	3 457																										
	White Oak / Ash	3 457																										
	<p><b>Nomono conference in height 900 mm</b> Available lengths: 2400, 2200, 2000, 1800 och 1600 mm.</p> <table border="0" data-bbox="518 1276 1460 1612"> <tr> <td>Width 700, 800 or 900 mm</td> <td>White HPL</td> <td>2 433</td> </tr> <tr> <td></td> <td>Oak / Ash</td> <td>2 915</td> </tr> <tr> <td></td> <td>Stained Ash</td> <td>2 915</td> </tr> <tr> <td></td> <td>White Oak / Ash</td> <td>2 915</td> </tr> <tr> <td>Width 1000 or 1100 mm</td> <td>White HPL</td> <td>2 975</td> </tr> <tr> <td></td> <td>Oak / Ash</td> <td>3 457</td> </tr> <tr> <td></td> <td>Stained Ash</td> <td>3 457</td> </tr> <tr> <td></td> <td>White Oak / Ash</td> <td>3 457</td> </tr> </table>				Width 700, 800 or 900 mm	White HPL	2 433		Oak / Ash	2 915		Stained Ash	2 915		White Oak / Ash	2 915	Width 1000 or 1100 mm	White HPL	2 975		Oak / Ash	3 457		Stained Ash	3 457		White Oak / Ash	3 457
Width 700, 800 or 900 mm	White HPL	2 433																										
	Oak / Ash	2 915																										
	Stained Ash	2 915																										
	White Oak / Ash	2 915																										
Width 1000 or 1100 mm	White HPL	2 975																										
	Oak / Ash	3 457																										
	Stained Ash	3 457																										
	White Oak / Ash	3 457																										
	<p><b>Nomono conference in height 1060 mm</b> Available lengths: 2400, 2200, 2000, 1800 och 1600 mm.</p> <table border="0" data-bbox="518 1702 1460 2038"> <tr> <td>Width 700, 800 or 900 mm</td> <td>White HPL</td> <td>2 433</td> </tr> <tr> <td></td> <td>Oak / Ash</td> <td>2 915</td> </tr> <tr> <td></td> <td>Stained Ash</td> <td>2 915</td> </tr> <tr> <td></td> <td>White Oak / Ash</td> <td>2 915</td> </tr> <tr> <td>Width 1000 or 1100 mm</td> <td>White HPL</td> <td>2 975</td> </tr> <tr> <td></td> <td>Oak / Ash</td> <td>3 457</td> </tr> <tr> <td></td> <td>Stained Ash</td> <td>3 457</td> </tr> <tr> <td></td> <td>White Oak / Ash</td> <td>3 457</td> </tr> </table>				Width 700, 800 or 900 mm	White HPL	2 433		Oak / Ash	2 915		Stained Ash	2 915		White Oak / Ash	2 915	Width 1000 or 1100 mm	White HPL	2 975		Oak / Ash	3 457		Stained Ash	3 457		White Oak / Ash	3 457
Width 700, 800 or 900 mm	White HPL	2 433																										
	Oak / Ash	2 915																										
	Stained Ash	2 915																										
	White Oak / Ash	2 915																										
Width 1000 or 1100 mm	White HPL	2 975																										
	Oak / Ash	3 457																										
	Stained Ash	3 457																										
	White Oak / Ash	3 457																										



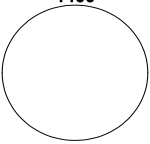
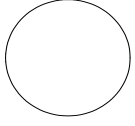
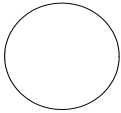
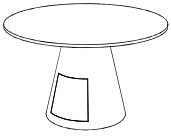
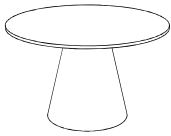
Illustration	Description	Article number	Material	EUR
<p><b>Tin Design: Morgan Rudberg och Lars Pettersson</b></p>  <p style="text-align: right;"></p> <p><b>Tin CONFERENCE TABLE</b></p> <ul style="list-style-type: none"> <li>• Desk tops in 19 mm MDF with matching list.</li> <li>• Rectangular table tops: radius 0.</li> <li>• Leg base of perforated, rolled steel sheet. White (31) or black (37).</li> <li>• Legs base with serice hatch for easy handling of cables.</li> <li>• Other RAL colours against quotation</li> <li>• Two desk heights: 73 and 90 cm.</li> <li>• Option: VX cable lid 06470 fits Tin.</li> <li>• For additional product information please see <a href="http://www.horreds.se">www.horreds.se</a></li> </ul> <p><b>Material:</b>            White HPL = closest NCS S0502-Y            Optional HPL: Light grey, Medium grey, Anthracite and Black            Linoleum: 4132 Ash, 4154 Burgundy, 4166 Charcoal, 4172 Mauve, 4174 Conifer, 4175 Pebble, 4176 Mushroom, 4177 Vapour, 4179 Smokey Blue, 4184 Olive.            Veneer group 1: Oak (03) and Ash (06)            Veneer group 2: Black stained ash (86) / Dark stained ash (76),            White pigm.oak(30), White pigm.ash (10) , Burgundy stained ash (C8), Conifer stained ash (D3), Smokey Blue stained ash (D4).</p>				
<b>Round table tops:</b>				
<p>1400</p> 	Table top diameter 1400 mm, excluding stand and cable lid	47 31 <b>1603174</b>	White HPL	1 211
		47 39 <b>1603174</b>	Opt. HPL	
		47 88 <b>1603174</b>	Linoleum	1 480
		47 xx <b>1603174</b>	Veneer 1	1 722
		47 xx <b>1603174</b>	Veneer 2	1 722
<p>1200</p> 	Table top diameter 1200 mm, excluding stand and cable lid	47 31 <b>1603175</b>	White HPL	491
		47 39 <b>1603175</b>	Opt. HPL	601
		47 88 <b>1603175</b>	Linoleum	695
		47 xx <b>1603175</b>	Veneer 1	555
		47 xx <b>1603175</b>	Veneer 2	555
<p>1100</p> 	Table top diameter 1100 mm, excluding stand and cable lid	47 31 <b>1603300</b>	White HPL	491
		47 39 <b>1603300</b>	Opt. HPL	601
		47 88 <b>1603300</b>	Linoleum	695
		47 xx <b>1603300</b>	Veneer 1	555
		47 xx <b>1603300</b>	Veneer 2	555
<b>Stands for round tops (excl table top):</b>				
	Tin stand <b>with</b> hatch.. Fits round table top (order separately) Desk heigh 73 cm	47 xx <b>73R-1</b>	White/black	2 790
	Like above but desk height 90 cm	47 xx <b>90R-1</b>	White/black	2 907
	Tin stand <b>without</b> hatch.. Fits round table top (order separately) Desk heigh 73 cm	47 xx <b>73R</b>	White/black	2 479
	Like above but desk height 90 cm	47 xx <b>90R</b>	White/black	2 596



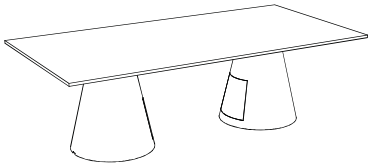
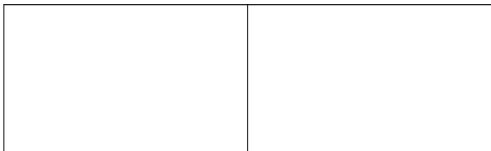
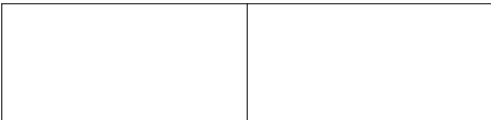
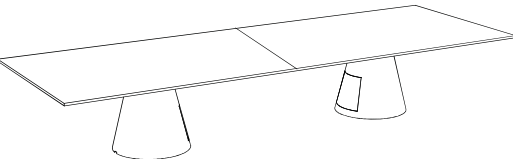
Illustration	Description	Article number	Material	EUR
<b>Rectangular table tops:</b>				
	Table top 2400x1400 mm excluding stand and cable lid	47 31 <b>16007713</b>	White HPL	1 211
		47 39 <b>16007713</b>	Opt. HPL	
		47 88 <b>16007713</b>	Linoleum	1 480
		47 xx <b>16007713</b>	Veneer 1	1 722
		47 xx <b>16007713</b>	Veneer 2	1 722
	Table top 2400x1200 mm excluding stand and cable lid	47 31 <b>1603439</b>	White HPL	731
		47 39 <b>1603439</b>	Opt. HPL	789
		47 88 <b>1603439</b>	Linoleum	1 171
		47 xx <b>1603439</b>	Veneer 1	843
		47 xx <b>1603439</b>	Veneer 2	843
<b>Stand for rectangular tops:</b>				
	Tin stand (x2) <b>with</b> hatches. Fits rectangular tops (order separately) Desk height 73 cm	47 xx <b>73LLDD-1</b>	White/black	6 066
	Like above but desk height 90 cm	47 xx <b>90LLDD-1</b>	White/black	6 298
<b>2-pieces rectangular table tops:</b>				
	Table top 4800x1400 (2 pieces) excluding stand and cable lid	47 31 <b>16xxxxx</b>	White HPL	2 536
		47 39 <b>16xxxxx</b>	Opt. HPL	
		47 88 <b>160xxxx</b>	Linoleum	3 073
		47 xx <b>160xxxx</b>	Veneer 1	3 558
		47 xx <b>160xxxx</b>	Veneer 2	3 558
	Table top 4800x1200 (2 pieces) excluding stand and cable lid	47 31 <b>1603440</b>	White HPL	1 576
		47 39 <b>1603440</b>	Opt. HPL	1 634
		47 88 <b>1603440</b>	Linoleum	2 456
		47 xx <b>1603440</b>	Veneer 1	1 799
		47 xx <b>1603440</b>	Veneer 2	1 799
<b>Stand for 2-piece rectangular tops:</b>				
	Tin stand (x2) <b>with</b> hatches. Fits 2-piece rectangular tops (order separately). Desk height 73 cm	47 xx <b>73LLDD-1</b>	White/black	6 563
	Like above but desk height 90 cm	47 xx <b>90LLDD-1</b>	White/black	6 796

Illustration	Description	Article number	Material	EUR
<b>CABLE SLOTS TO MEETING TABLES</b>				
Cable entries and Hub suitable for: • VX Conference • VX Project				
<b>Cable lid on hinges</b>				
	Cable lid for conference table, chamfered edge, Length 600 mm. Incl. cable tray (white/black) Size of cable entry: 600x170 mm, with 2 flaps each 596x75 mm.  Power socket to be ordered separately. <i>Not to tables in white direct laminate!</i>	34 31 <b>04967</b> 34 xx <b>04967</b> 34 xx <b>04967</b>	White HPL. Opt.HPL Linoleum	455 455 455
	Cable lid for conference table, chamfered edge, Length 600 mm. Incl. cable tray (white/black) Size of cable entry: 600x170 mm, with 2 flaps each 575x72 mm.  Power socket to be ordered separately.  Always produced in same material as the table top with matching of veneer.	35 xx <b>980x</b>	Veneer	607
		Axessline socket with 5xpower, 2xUSB-laddare, 1xHDMI, 4xData, och 2xUSB. 2 m cable.	93 5- <b>T5UD-15</b>	
	Power socket 3-ways, 3 m cable	93 6- <b>E3V30B</b>	Black	27
	Power socket 6-ways, 3 m cable	93 6- <b>E6V30B</b>	Black	32
	<b>Hub</b> • Screens for Hub, see page 106.			
	Hub in Forbo linoleum, with 4 x power (PM50) and 4 x USB -C charger (PM52). Prepared for lamp Sempé and Hub desk screens	34 XX <b>08350</b>	Linoleum	1 101
	Hub in steel, with 4 x power (PM50) and 4 x USB -C charger (PM52). White (RAL9016) alt.black (RAL9005) structure. Prepared for lamp Sempé and Hub desk screens	34 31 <b>09502</b> 34 37 <b>09502</b>	White Black	1 009 1 009
	Cable tray conference 670x200x140 mm.	34 31 <b>04381</b> 34 37 <b>04381</b>	White Black	157 157
	Lampa Mushroom for mounting in HUB. Lamp for mounting in table top, including drilling Powder coated in black fine structure. Incl lightsource: LED E27 2700K 380lm CRI<80 (2pcs) Pull switch. Diameter 390mm, height 400 mm.	34 37 P380 34 37 P380B	Black Black	844 954





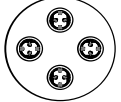


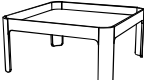

Illustration	Description	Article number	Material	EUR
	<p><b>MIT</b> Design: Thomas Bernstrand och Stefan Borselius</p> <p>Accessoriet suitable for:</p> <ul style="list-style-type: none"> <li>• VX Konferens</li> <li>• VX Projekt Konferens</li> <li>• Tin</li> </ul>			
	<p>Socket strip single with 4 x power (PM50) 348x108 mm</p>	<p>74 31 <b>08179-4</b> 74 37 <b>08179-4</b></p>	<p>Vit Svart</p>	<p>259 259</p>
	<p>Socket strip double with 4 x power (PM50) 188x188 mm</p>	<p>74 31 <b>08182-4</b> 74 37 <b>08182-4</b></p>	<p>Vit Svart</p>	<p>259 259</p>
	<p>Socket strip double with 6 x power (PM50) 268x188 mm</p>	<p>74 31 <b>08182-6</b> 74 37 <b>08182-6</b></p>	<p>Vit Svart</p>	<p>365 365</p>
	<p>Socket strip round with 4 x power (PM50) ø 245 mm</p>	<p>74 31 <b>08208-4</b> 74 37 <b>08208-4</b></p>	<p>Vit Svart</p>	<p>258 258</p>
	<p>Socket strip round with 6 x power (PM50) ø 245 mm</p>	<p>74 31 <b>08208-6</b> 74 37 <b>08208-6</b></p>	<p>Vit Svart</p>	<p>348 348</p>
	<p>Upcharge for alternative powerdot with double USB-C PD charger (PM52) <u>Note: price for 1 piece</u></p>			<p>55</p>
	<p>Accessories tray for socket strip 08179-4 358x118x100 mm</p>	<p>74 31 <b>08175-4</b> 74 37 <b>08175-4</b></p>	<p>White Black</p>	<p>544 544</p>
	<p>Accessory tray for socket strip 08124-4 198x198x100 mm</p>	<p>74 31 <b>08180-4</b> 74 37 <b>08180-4</b></p>	<p>White Black</p>	<p>544 544</p>
	<p>Accessory tray for socket strip 08124-6 278x198x100 mm</p>	<p>74 31 <b>08180-6</b> 74 37 <b>08180-6</b></p>	<p>White Black</p>	<p>617 617</p>


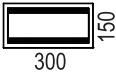






Illustration	Description	Article number	Material	EUR
<b>Bibox (Also fits Nomono conference)</b>				
	Bi-Box Large, openable cover and cable tray in one, including predrilling cost.	72 10 <b>01-1</b>	White	518
		72 10 <b>01-2</b>	Black	518
	Power Inlay for Bi-box Large: 4xPower, 4xData and 4xUSB.	72 10 <b>04</b>		330
	Bi-Box Small, openable cover and cable tray in one, including predrilling cost.	72 10 <b>00-1</b>	White	285
		72 10 <b>00-2</b>	Black	285
	Power Inlay for Bi-box Small: 3xPower and 2xData.	72 10 <b>02</b>		145
<b>Cable lid (Also fits Tin)</b>				
	VX cable lid, diameter 260 mm. Incl cable tray (black or white) with PD10 power + magic hole), The cable lid is in same material as the table top	34 xxxx <b>06470</b>		489
	Add.price for alternative powers: PD12 (power, computer, USB-charger)		add. / port	100
	PD13 (power HDMI, USB) <b>Note: add prices are per each power.</b>		add. / port	136
<b>Powerdots (also fits Tin and Nomono conference)</b>				
	Powerdot cable entry 80 mm 1 x el + 4 x Magic Holes	935 <b>-PD10</b>	Black	66
		935 <b>-PD10W</b>	White	66
	Powerdot cable entry 80 mm. 1 power, 2 USB-C charger (2x30W), 1 magic hole ø8 mm.	935 <b>-PD17</b>	Black	190
		935 <b>-PD17W</b>	White	190
	Powerdot cable entry 60 mm. 1 power, 1 USB-laddare.	935 <b>-PM61</b>	Black	103
		935 <b>-PM61W</b>	White	103
	Powerdot cable entry 60 mm. 1 power, 1 USB-IC PD charger	935 <b>-PM62</b>	Black	144
		935 <b>-PM62W</b>	White	144
	Cordless charger ø 60 mm.	935 <b>-QI60</b>	Black	176
		935 <b>-QI60W</b>	White	176
	Cable entry customised	<b>HÅLT.2</b>		121
	Kable sock ø 20mm in braided textile. Length 1500 mm. With zipper...	32 54 <b>000109</b>	Black	39
		32 54 <b>000101</b>	White	39
	Cable pipe in textile. Length1500 mm	29 31 <b>1500</b>	Black	119
		29 37 <b>1500</b>	White	119




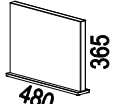
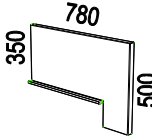
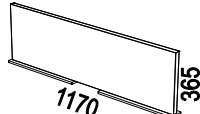
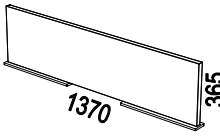

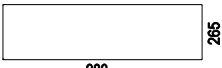
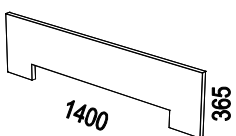
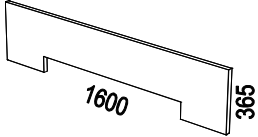
Illustration	Description	Article number	Material	EUR	
<p><b>Screens</b></p> <ul style="list-style-type: none"> <li>• Thickness 35 mm, of which 30 mm in sound absorbing material</li> <li>• For other fabrics; please ask for quotation.</li> </ul>					
<p><b>Price group 1:</b>                      Camira: <b>Cara, Carlow</b>                      Gabriel: <b>Event Screen, Hush</b></p>		<p><b>Price group 2:</b>                      Camira: <b>Blazer Lite</b>                      Gabriel: <b>Soul, Soul Mel, Twist, Twist Mel, Focus Melange Screen, Cura Screen</b>                      Kvadrat: <b>Hint</b></p>		<p><b>Price group 3:</b>                      Camira: <b>Blazer, Main Line Flax</b>                      Gabriel: <b>Step Melange Screen</b>                      Kvadrat: <b>Remix, Remix Screen, Floyd Scr.</b></p>	
<p><b>Free standing screens</b></p>					
	Sound absorbing side screen 480x365x35 mm with foot in wood (ø 250mm) Foot available in hard vaxed oiled oak and stained ash.	34 xx 09147-x	PG 1 PG 2 PG 3	371 397 422	
	Sound absorbing side screen 480x365x35 mm Including foot in laquered steel. Choose colour of the foot; white or black.	34 xx <b>03374-x</b>	PG 1 PG 2 PG 3	292 310 338	
	Sound absorbing side screen 780x350x35 mm. Including foot in laquered steel. Choose colour of the foot; white or black.	34 xx <b>06360-x</b>	PG 1 PG 2 PG 3	362 398 434	
	Sound absorbing side screen 1170x365x35 mm Including foot in laquered steel. Choose colour of the foot; white or black.	34 xx <b>04360-x</b>	PG 1 PG 2 PG 3	550 589 643	
	Sound absorbing side screen 1370x365x35 mm Including foot in laquered steel. Choose colour of the foot; white or black.	34 xx <b>04361-x</b>	PG 1 PG 2 PG 3	566 610 665	
	Pen tray for side screen on foot.	34 31 <b>03357</b> 34 37 <b>03357</b>	White Black	68 68	
<p><b>Screens for Hub</b></p>					
	Sound absorbing desk screen 980x265x35 mm, for mounting in Hub. Incl white or black fittings.	34 xx <b>03375-x</b>	PG 1 PG 2 PG 3	352 377 411	
	Sound absorbing desk screen 1400x365x35 mm, for mounting in Hub. Incl white or black fittings.	34 xx <b>04358-x</b>	PG 1 PG 2 PG 3	402 428 467	
	Sound absorbing desk screen 1600x365x35 mm, for mounting in Hub. Incl white or black fittings.	34 xx <b>04359-x</b>	PG 1 PG 2 PG 3	420 451 492	


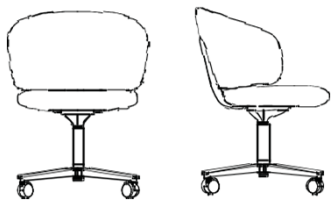
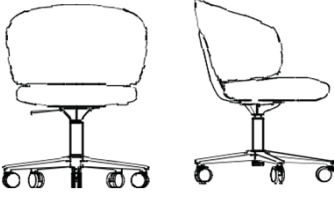
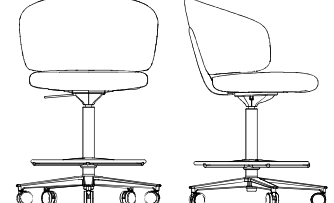
Illustration	Description	Article number	Price group	EUR
<b>Prime Design: Fredrik Mattson</b>				
	<p><b>Prime STOL</b></p> <ul style="list-style-type: none"> <li>Fully upholstered conference or meeting chair.</li> <li>Seat of molded HR foam on plywood, molded back with metal insert.</li> <li>CMHR foam for an extra charge € 68.</li> <li>4-wing aluminum stand with castors, rotatable, with damping.</li> <li>5-wing aluminum stand with castors, height adjustable.</li> <li>Castors with polyurethane tread, suitable for all floors.</li> <li>For more product information see <a href="http://www.horreds.se">www.horreds.se</a></li> </ul> <p>Stand colours:            Black RAL 9005 (37) - standard            Optional colours - see page 164 - at extra cost            Polished top side (13) - at extra cost</p>			
 <p>Seat height: 46cm            Width: 60cm            Height: 82cm            Depth: 57cm</p>	<p>4-wing black aluminium stand with castors.            Fixed height, tilt, swivel, damping.</p> <p>*NB Leather: min quantity 2 pcs in same colour</p> <p><i>Upcharge optional colours (black castors+tilt)</i>  <i>Upcharge polished stand (black details)</i>  <i>Upcharge for interval braked castors</i></p>	<p>50 xx <b>20A-xxx</b></p> <p>50 yy <b>20A-xxx</b></p> <p>50 13 <b>20A-xxx</b></p> <p>50 xx <b>22A-xxx</b></p>	<p>PG 1            PG 2            PG 3            PG 4            PG 5            PG 6            PG 7            Leather*</p>	<p>1 023            1 065            1 110            1 156            1 209            1 281            1 382            1 502</p> <p>78            29            27</p>
 <p>Sea height: 43-55cm            Width: 60cm            Height: 79-91cm            Depth: 60 cm</p>	<p>5-wing black aluminium stand with castors.            Height adjustable 43-55cm, tilt, swivel.</p> <p>*NB Leather: min quantity 2 pcs in same colour</p> <p><i>Upcharge optional colours (black castors+tilt)</i>  <i>Upcharge polished stand (black details)</i>  <i>Upcharge for interval braked castors</i></p>	<p>50 xx <b>10A-xxx</b></p> <p>50 yy <b>10A-xxx</b></p> <p>50 13 <b>10A-xxx</b></p> <p>50 xx <b>12A-xxx</b></p>	<p>PG 1            PG 2            PG 3            PG 4            PG 5            PG 6            PG 7            Leather*</p>	<p>1 040            1 083            1 128            1 173            1 226            1 298            1 399            1 519</p> <p>78            29            27</p>
 <p>Seat height: 60-80cm            Width: 60cm            Height: 79-91cm            Depth: 60 cm</p>	<p>High 5-wing black aluminium stand with castors. Height adjustable 60-80cm, tilt, swivel and interval braked castors.            Adjustable footrest black/chrome</p> <p>*NB Leather: min quantity 2 pcs in same colour</p>	<p>50 37 <b>30A-xxx</b></p>	<p>PG 1            PG 2            PG 3            PG 4            PG 5            PG 6            PG 7            Leather*</p>	<p>1 218            1 260            1 306            1 351            1 404            1 476            1 577            1 697</p>





Illustration	Description	Article number	Price	EUR
<b>Grand Design: Thomas Bernstrand and Stefan Borselius</b>				
	<p><b>Grand CHAIR</b></p> <ul style="list-style-type: none"> <li>• Upholstered confence or meeting chair.</li> <li>• Seat of HR-foam on plywood, molded back with metal inserts.</li> <li>• Upcharge for CHMR-foam: € 60.</li> <li>• Arm rest in solid oak / ash or black leather.</li> <li>• Leather armchairs always have leatherclad armrests as standard.</li> <li>• Can also be ordered without armrests.</li> <li>• 5-wing aluminum stand with castors. Powder coated (black and white).</li> <li>• 4-wing aluminum stand with or without castors. Powder coated (black and white).</li> <li>• Lounge model with foot plate and autoreturn. Powder coated (black and white).</li> <li>• Castors with polyurethane roller track, suitable for all floors.</li> <li>• Price for leather chairs in less than 2 pieces; against quotation.</li> <li>• For more product information, see <a href="http://www.horreds.com">www.horreds.com</a></li> </ul>			
	<p><u>Stands:</u> WhiteRAL 9016 (31) Black RAL 9005 (37)</p>	<p><u>Armrests:</u> Oak (03), Ash (06), Black ash (86), Dark ash (76), White oak (30), White ash (10)</p>		
<p><b>5-WINGED WITH CASTORS</b></p> <ul style="list-style-type: none"> <li>• Seat height 44-49 cm</li> <li>• Height of low back 82-87 cm / high back 104-109 cm</li> <li>• Width 67 cm</li> <li>• Height armrests 63-69 cm</li> <li>• Depth 65 cm</li> </ul>				
	<p>Chair with low back and armrests in solid oak / ash (nature/white pigm../dark stained). 5-wing stand, adjustable height 44-49 cm, tilt. Black (37 ) White (31)</p> <p>*Note:Leather minimum 2 pcs in same color, always matching leather on armrests</p>	<p>71 xx xx <b>11M-xxx</b></p> <p>71 xx 97 <b>11M-xxx</b></p> <p>71 xx xx <b>12M-xxx</b></p> <p>71 xx 00 <b>11M-xxx</b></p>	<p>PG 1 PG 2 PG 3 PG 4 PG 5 PG 6 PG 7 Leather*</p>	<p>1 309 1 346 1 387 1 428 1 474 1 525 1 597 1 674</p> <p>41 27 -116</p>
	<p>Chair with high back and armrests in solid oak / ash (nature/white pigm../dark stained). 5-wing stand, adjustable height 44-49 cm, tilt. Black (37 ) White (31)</p> <p>*Note:Leather minimum 2 pcs in same color, always matching leather on armrests</p>	<p>71 xx xx <b>11H-xxx</b></p> <p>71 xx 97 <b>11H-xxx</b></p> <p>71 xx xx <b>12H-xxx</b></p> <p>71 xx 00 <b>11H-xxx</b></p>	<p>PG 1 PG 2 PG 3 PG 4 PG 5 PG 6 PG 7 Leather*</p>	<p>1 504 1 550 1 601 1 653 1 710 1 773 1 864 1 971</p> <p>41 27 -116</p>


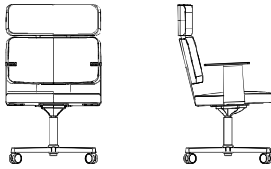
Illustration	Description	Article number	Price	EUR
<p><b>4-WING WITH CASTORS</b></p> <ul style="list-style-type: none"> <li>• Seat height 46 cm</li> <li>• Height of low back 84 cm / high back 106 cm</li> <li>• Width including armrest 60 cm / exclusive armrest 59 cm</li> <li>• Height armrest 67cm</li> <li>• Depth 59 cm</li> </ul>				
	Chair with low back and armrests in solid oak / ash (nature/white pigm../dark stained). 4-wing stand with castors, fixed height 46 cm. Tilt. Black (37 ) White (31)	71 xx xx <b>20M-xxx</b>	PG 1 PG 2 PG 3 PG 4 PG 5 PG 6 PG 7 Leather*	1 262 1 298 1 339 1 381 1 427 1 477 1 550 1 626
	*Note:Leather minimum 2 pcs in same color, always matching leather on armrests			
	Upcharge armrests in black leather	71 xx 97 <b>20M-xxx</b>		41
	Upcharge for interval braked castors	71 xx xx <b>22M-xxx</b>		27
	Deduction for chair without armrests	71 xx 00 <b>20M-xxx</b>		-116
	Chair with high back and armrests in solid oak / ash (nature/white pigm../dark stained). 4-wing stand with castors, fixed height 46 cm. Tilt. Black (37 ) White (31)	71 xx xx <b>20H-xxx</b>	PG 1 PG 2 PG 3 PG 4 PG 5 PG 6 PG 7 Leather*	1 458 1 503 1 555 1 606 1 663 1 727 1 818 1 924
	*Note:Leather minimum 2 pcs in same color, always matching leather on armrests			
	Upcharge armrests in black leather	71 xx 97 <b>20H-xxx</b>		41
	Upcharge for interval braked castors	71 xx xx <b>22H-xxx</b>		27
	Deduction for chair without armrests	71 xx 00 <b>20H-xxx</b>		-116

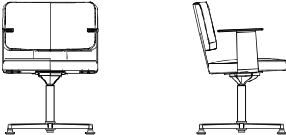
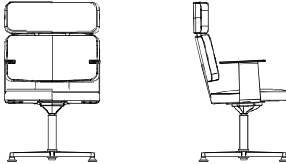
Illustration	Description	Article number	Price	EUR	
<p><b>4-WING WITH GLIDES</b></p> <ul style="list-style-type: none"> <li>• Seat height 46 cm</li> <li>• Height of low back 84 cm / high back 106 cm</li> <li>• Width including armrest 60 cm / exclusive armrest 59 cm</li> <li>• Height armrest 67cm</li> <li>• Depth 59 cm</li> </ul>					
	<p>Chair with low back and armrests in solid oak / ash (nature/white pigm../dark stained). 4-wing stand without castors, fixed height 46 cm. Tilt. Black (37 ) White (31)</p> <p>Glides are always black.</p> <p>*Note:Leather minimum 2 pcs in same color, always matching leather on armrests</p> <p>Upcharge armrests in black leather</p> <p>Deduction for chair without armrests</p>	71 xx xx <b>21M-xxx</b>	PG 1	1 233	
			PG 2	1 270	
			PG 3	1 311	
				PG 4	1 352
				PG 5	1 398
				PG 6	1 449
				PG 7	1 521
				Leather*	1 598
					41
		71 xx 00 <b>21M-xxx</b>			-116
	<p>Chair with high back and armrests in solid oak / ash (nature/white pigm../dark stained). 4-wing stand without castors, fixed height 46 cm. Tilt. Black (37 ) White (31)</p> <p>Glides are always black.</p> <p>*Note:Leather minimum 2 pcs in same color, always matching leather on armrests</p> <p>Upcharge armrests in black leather</p> <p>Deduction for chair without armrests</p>	71 xx xx <b>21H-xxx</b>	PG 1	1 429	
			PG 2	1 475	
			PG 3	1 526	
				PG 4	1 578
				PG 5	1 635
				PG 6	1 699
				PG 7	1 789
				Leather*	1 896
					41
		71 xx 00 <b>21H-xxx</b>			-116

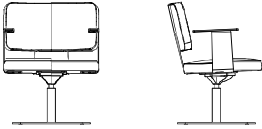
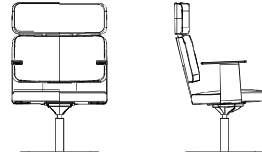

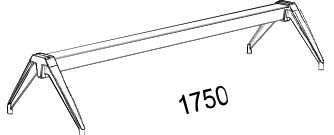
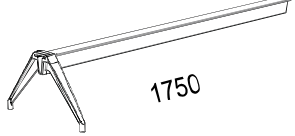
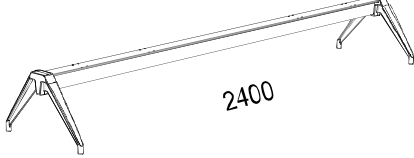
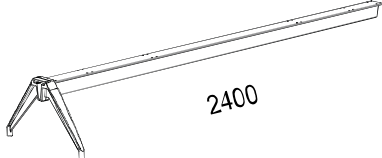
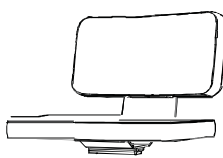


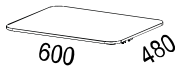
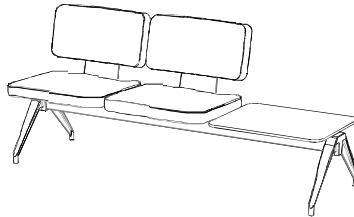
Illustration	Description	Article number	Price	EUR
<p><b>LOUNGE CHAIR WITH FOOT PLATE</b></p> <ul style="list-style-type: none"> <li>• Seat height 41 cm</li> <li>• Height of back 79 cm / high back 101 cm</li> <li>• Width including armrest 60 cm / exclusive armrest 59 cm</li> <li>• Height armrest 67cm</li> <li>• Depth 59 cm</li> </ul>				
	<p>Chair with low back and armrests in solid oak / ash (nature/white pigm../dark stained). Lounge chair with foot plate, fixed height. tilt and autoreturn. Black (37 ) White (31)</p> <p>*Note:Leather minimum 2 pcs in same color, always matching leather on armrests Upcharge armrests in black leather Deduction for chair without armrests</p>	<p>71 xx xx <b>30M-xxx</b></p> <p>71 xx 00 <b>30M-xxx</b></p>	<p>PG 1 PG 2 PG 3 PG 4 PG 5 PG 6 PG 7 Leather*</p>	<p>1 306 1 343 1 384 1 425 1 471 1 522 1 594 1 671</p> <p>41 -116</p>
	<p>Chair with high back and armrests in solid oak / ash (nature/white pigm../dark stained). Lounge chair with foot plate, fixed height. tilt and autoreturn. Black (37 ) White (31)</p> <p>*Note:Leather minimum 2 pcs in same color, always matching leather on armrests Upcharge armrests in black leather Deduction for chair without armrests</p>	<p>71 xx xx <b>30H-xxx</b></p> <p>71 xx 00 <b>30H-xxx</b></p>	<p>PG 1 PG 2 PG 3 PG 4 PG 5 PG 6 PG 7 Leather*</p>	<p>1 502 1 548 1 599 1 650 1 708 1 772 1 862 1 969</p> <p>41 -116</p>

Illustration	Description	Article number	Price group	EUR
<b>Grand Balk Design: Thomas Bernstrand och Stefan Borselius</b>				
	<p><b>GRAND BALK Sofa</b></p> <ul style="list-style-type: none"> <li>Fully upholstered buildable beam sofa in seat height 46 cm.</li> <li>Beam and legs in recycled aluminum, powder coated.</li> <li>Seat module of molded HR raom on plywood, molded back with metal insert.</li> <li>CMHR foam for an additional € 60.</li> <li>Arms upport in solid oak / ash. Black leather for an additional € 41.</li> <li>Armchairs in leather always have leather-covered handles in same colour.</li> <li>For mor product information see <a href="http://www.horreds.se">www.horreds.se</a></li> </ul>			
	<p>Beam, freestanding, for 3 modules Length 1750mm</p>	71 37 <b>1750</b>	Black	1 043
	<p>Beam, for coupling, for 3 modules Lengt 1750mm, with 1 leg. <i>To be used together with freestanding beam</i></p>	71 37 <b>1750K</b>	Black	924
	<p>Beam, freestanding, for 4 modules Length 2400mm</p>	71 37 <b>2400</b>	Black	1 215
	<p>Beam, for coupling, for 4 modules Lengt 2400mm, with 1 leg. <i>To be used together with freestanding beam</i></p>	71 37 <b>2400K</b>	Black	1 096
	<p>Seating module with black back plate. Incl. clamp to beam.</p> <ul style="list-style-type: none"> <li>Width 59cm</li> <li>Depth 59cm</li> <li>Back height 82cm (above floorv)</li> </ul> <p>*NB:Leather minimum 2 pcs in same colour,</p>	71 37 <b>00M-x</b>	PG 1 PG 2 PG 3 PG 4 PG 5 PG 6 PG 7 Leather*	788 828 868 907 953 1 014 1 106 1 182
	<p>Upcharge for armsupport right / left Note: Price per piece Black bracket with armsupport in solid oak/ash (clear coated or stained in standard stains.</p>	71 xx37 <b>08129H</b> 71 xx37 <b>08129V</b>	black/veneer black/veneer	58 58
	<p>Table top 480x300mm, incl clamp, corresponds to 0,5 module. With edging and chamfered edge.</p>	71 xx37 <b>-300</b>	Veneer Laminate Linoleum	206 206 206
	<p>Table top 480x600mm, incl clamp, corresponds to 1 module. With edging and chamfered edge.</p>	71 xx37 <b>-600</b>	Veneer Laminate Linoleum	355 355 355

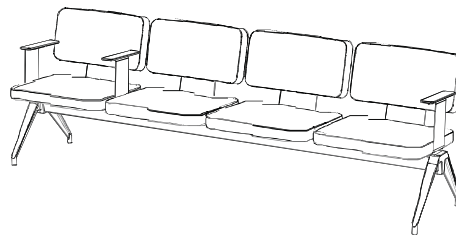
	Electricity / charging in table top - required 2 pcs / table.					
	1 x Power	935	<b>PM50</b>	Black	63	
	2x USB-C charger	935	<b>PM52</b>	Black	144	
	Kabelstrumpa i textil 1500mm	29	37	<b>1500</b>	Black	119

**Price example 1:**



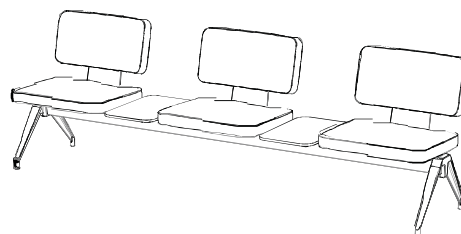
Freestanding beam for 3 modules	art nr 71 37 1750	Material	Pieces	Price/pce	Total
Seating module	art 71 37 00M-x	Black	1	1 043	1 043
Table top 480x600 mm, incl clamp	art 71 06 37-600	PG 1	2	788	1 576
		Ash	1	355	355
					<b>2 974</b>

**Price example 2:**



Freestanding beam for 4 modules	art nr 71 37 2400	Material	Pieces	Price/pce	Total
Seating module	art 71 37 00M-x	Black	1	1 215	1 215
Armrest right	art 71 37 06 08129H	PG 1	4	788	3 152
Armrest left	art 71 37 06 08129V	Black/ash	1	58	58
		Black/ash	2	58	116
					<b>4 367</b>

**Price example 3:**



Freestanding beam for 4 modules	art nr 71 37 2400	Material	Pieces	Price/pce	Total
Seating module	art 71 37 00M-x	Svart	1	1 215	1 215
Table top 480x300 mm, incl clamp	art 71 06 37-300	Tyg PG 1	3	788	2 364
		Ask	2	206	412
					<b>3 991</b>

Corner setups / other lengths? Please contact us for quotation.



**Glove** Design: Fredrik Mattson**Glove Medium and High**

- Upholstered conference/meeting chair in high or medium design.
- Molded cold foam (HR) with metal frame. Upcharge for CMHR foam; € 36.
- Castors with polyurethane roller conveyor, suitable for all floors.
- Selected stands are available in optional colours, others on request. See page 164 for more info.
- For fabric selection; see Fabrics - Price Groups. If other fabric desired; contact us for a quote.
- Channel-sewn upholstery Bolster as an option in price group 1-7 excl. artificial leather.
- 6 different stands:



5-wing aluminum stand in black, optional colours or polished. Tilt, adjustable height 43-53cm.



4-wing aluminum stand with castors and tilt. Black, optional colours or polished.



4-wing aluminum stand with sliding feet and tilt. Black alt. white powder coating or polished aluminum.



5-wing steel stand in black and optional colour. Tilt, fixed height 45cm. Option: adjustable height 43-52cm.



4-legged steel stand in black alt. white powder coating or chrome.



4-legged wooden stand in oak alt. ash.

**Glove Bolster Cover**

Do you have a Glove that needs to be renewed?

Glove Bolster Cover is now available, a cover for Glove High and Medium.

The bolster cover not only gives Glove a new life, but also a new character.

A figure-hugging, looser and slightly more comfortable sitting experience.



- For more product information, see [www.horreds.se](http://www.horreds.se)


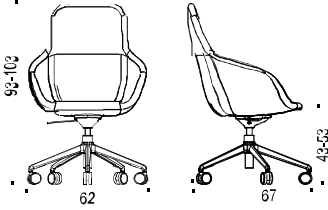
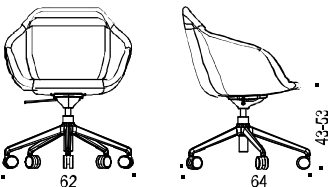
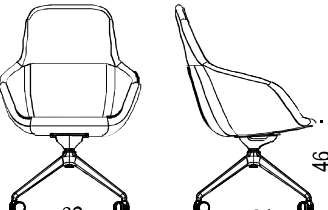
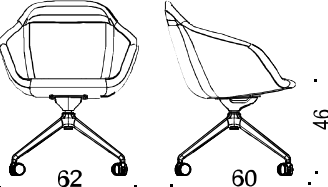
Illustration	Description	Article number	Price group	EUR
<b>Glove Design: Fredrik Mattson</b>				
<b>Glove CHAIR</b>				
	<p>Chair, high back. 5-wing aluminum base, with tilt, rotatable, adjustable height 43-53 cm. Black base (37).</p> <p>*NB: Leather min. 2 chairs in same colour <i>Upcharge for Bolster upholstery pg 1-7**</i> <i>Upcharge for interval braked castors</i> <i>Upcharge polished stand (black tilt)</i> <i>Upcharge for swing with adj. hardness</i> <i>Upcharge opt.colours stand (black castors/tilt)</i></p>	<p>51 37 <b>51H01-xxx</b></p> <p>51 xx <b>51H0B-xxx</b></p> <p>51 xx <b>51H11-xxx</b></p> <p>51 13 <b>51H01-xxx</b></p> <p>51 xx <b>52H01-xxx</b></p> <p>51 yy <b>51H01-xxx</b></p>	<p>PG 1</p> <p>PG 2</p> <p>PG 3</p> <p>PG 4</p> <p>PG 5</p> <p>PG 6</p> <p>PG 7</p> <p>Leather*</p>	<p>1 058</p> <p>1 107</p> <p>1 162</p> <p>1 217</p> <p>1 279</p> <p>1 347</p> <p>1 445</p> <p>1 501</p> <p>139</p> <p>27</p> <p>55</p> <p>96</p> <p>78</p>
	<p>Chair, medium back. 5-wing aluminum stand, with tilt, rotatable, adjustable height 43-53 cm. Blak base (37).</p> <p>*NB: Leather min. 2 chairs in same colour <i>Upcharge for Bolster upholstery pg 1-7**</i> <i>Upcharge for interval braked castors</i> <i>Upcharge polished stand (black tilt)</i> <i>Upcharge for swing with adj. hardness</i> <i>Upcharge opt.colours stand (black castors/tilt)</i></p>	<p>51 37 <b>51M01-xxx</b></p> <p>51 xx <b>51M0B-xxx</b></p> <p>51 xx <b>51M11-xxx</b></p> <p>51 13 <b>51M01-xxx</b></p> <p>51 xx <b>52M01-xxx</b></p> <p>51 yy <b>51M01-xxx</b></p>	<p>PG 1</p> <p>PG 2</p> <p>PG 3</p> <p>PG 4</p> <p>PG 5</p> <p>PG 6</p> <p>PG 7</p> <p>Leather*</p>	<p>979</p> <p>1 021</p> <p>1 069</p> <p>1 117</p> <p>1 171</p> <p>1 230</p> <p>1 314</p> <p>1 440</p> <p>139</p> <p>27</p> <p>55</p> <p>96</p> <p>78</p>
	<p>Chair, high back. 4-winged aluminium base with castors and tilt, turnable. Blak base (37).</p> <p>*NB: Leather min. 2 chairs in same colour <i>Upcharge for Bolster upholstery pg 1-7**</i> <i>Upcharge polished stand (black tilt)</i> <i>Upcharge opt.colours stand (black castors/tilt)</i></p>	<p>51 37 <b>31H01-xxx</b></p> <p>51 xx <b>31H0B-xxx</b></p> <p>51 13 <b>31H01-xxx</b></p> <p>51 yy <b>31H01-xxx</b></p>	<p>PG 1</p> <p>PG 2</p> <p>PG 3</p> <p>PG 4</p> <p>PG 5</p> <p>PG 6</p> <p>PG 7</p> <p>Leather*</p>	<p>1 013</p> <p>1 062</p> <p>1 117</p> <p>1 172</p> <p>1 234</p> <p>1 302</p> <p>1 400</p> <p>1 456</p> <p>139</p> <p>42</p> <p>63</p>
	<p>Chair, medium back. 4-winged aluminium base with castors and tilt, turnable. Blak base (37).</p> <p>*NB: Leather min. 2 chairs in same colour <i>Upcharge for Bolster upholstery pg 1-7**</i> <i>Upcharge polished stand (black tilt)</i> <i>Upcharge opt.colours stand (black castors/tilt)</i></p>	<p>51 37 <b>31M01-xxx</b></p> <p>51 xx <b>31M0B-xxx</b></p> <p>51 13 <b>31M01-xxx</b></p> <p>51 yy <b>31M01-xxx</b></p>	<p>PG 1</p> <p>PG 2</p> <p>PG 3</p> <p>PG 4</p> <p>PG 5</p> <p>PG 6</p> <p>PG 7</p> <p>Leather*</p>	<p>934</p> <p>976</p> <p>1 024</p> <p>1 072</p> <p>1 125</p> <p>1 184</p> <p>1 269</p> <p>1 395</p> <p>139</p> <p>42</p> <p>63</p>

Illustration	Description	Article number	Price group	EUR
	<p>Chair, high back 4-winged aluminium base with glides and tilt, turnable. Base black (37)</p> <p>*NB: Leather min. 2 chairs in same colour <i>Upcharge for Bolster upholstery pg 1-7**</i> <i>Upcharge polished alu (13) alt. white (31)</i> <i>Upcharge for felt glides</i> <i>Upcharge for auto-return</i></p>	<p>51 37 <b>32H01-xxx</b></p> <p>51 xx <b>32H0B-xxx</b></p> <p>51 xx <b>32H01-xxx</b></p> <p>51 xx <b>32HF1-xxx</b></p> <p>51 xx <b>33H01-xxx</b></p>	<p>PG 1 PG 2 PG 3 PG 4 PG 5 PG 6 PG 7 Leather*</p>	<p>985 1 034 1 089 1 144 1 206 1 274 1 372 1 428 139 42 11 46</p>
	<p>Chair, medium back 4-winged aluminium base with glides and tilt, turnable. Base black (37)</p> <p>*NB: Leather min. 2 chairs in same colour <i>Upcharge for Bolster upholstery pg 1-7**</i> <i>Upcharge polished alu (13) alt. white (31)</i> <i>Upcharge for felt glides</i> <i>Upcharge for auto-return</i></p>	<p>51 37 <b>32M01-xxx</b></p> <p>51 xx <b>32M0B-xxx</b></p> <p>51 xx <b>32M01-xxx</b></p> <p>51 xx <b>32MF1-xxx</b></p> <p>51 xx <b>33M01-xxx</b></p>	<p>PG 1 PG 2 PG 3 PG 4 PG 5 PG 6 PG 7 Leather*</p>	<p>906 949 997 1 044 1 098 1 157 1 241 1 368 139 42 11 46</p>
	<p>Chair, high back. 5-winged black (37) steel base with castors and tilt, rotatable, fixed height 45 cm.</p> <p>*NB: Leather min. 2 chairs in same colour <i>Upcharge for Bolster upholstery pg 1-7**</i> <i>Upcharge for interval braked castors</i> <i>Upcharge for tilt and adj. Height 43-52 cm</i> <i>Upcharge for swing and adjustable height</i> <i>Upcharge opt.colours stand (black castors/tilt)</i></p>	<p>51 37 <b>44H01-xxx</b></p> <p>51 xx <b>44H0B-xxx</b></p> <p>51 xx <b>44H11.xxx</b></p> <p>51 xx <b>45H01-xxx</b></p> <p>51 xx <b>41H01-xxx</b></p> <p>51 yy <b>44H01-xxx</b></p>	<p>PG 1 PG 2 PG 3 PG 4 PG 5 PG 6 PG 7 Leather*</p>	<p>1 190 1 239 1 294 1 349 1 411 1 479 1 577 1 633 139 27 28 96 63</p>
	<p>Chair, high back. 5-winged black (37) steel base with castors and tilt, rotatable, fixed height 45 cm.</p> <p>*NB: Leather min. 2 chairs in same colour <i>Upcharge for Bolster upholstery pg 1-7**</i> <i>Upcharge for interval braked castors</i> <i>Upcharge for tilt and adj. Height 43-52 cm</i> <i>Upcharge for swing and adjustable height</i> <i>Upcharge opt.colours stand (black castors/tilt)</i></p>	<p>51 37 <b>44M01-xxx</b></p> <p>51 xx <b>44M0B-xxx</b></p> <p>51 xx <b>44M11.xxx</b></p> <p>51 xx <b>45M01-xxx</b></p> <p>51 xx <b>41M01-xxx</b></p> <p>51 yy <b>44M01-xxx</b></p>	<p>PG 1 PG 2 PG 3 PG 4 PG 5 PG 6 PG 7 Leather*</p>	<p>1 111 1 153 1 201 1 249 1 302 1 361 1 446 1 572 139 27 28 96 63</p>

Illustration	Description	Article number	Price group	EUR
	<p>Chair, high back, 4 metal legs Base white (31) or black (37).</p> <p><i>*NB: Leather min. 2 chairs in same colour Upcharge for Bolster upholstery pg 1-7** Upcharge for base in chrome (13)</i></p>	<p>51 xx <b>20H01-xxx</b></p> <p>51 xx <b>20H0B-xxx</b></p> <p>51 13 <b>20H01-xxx</b></p>	<p>PG 1 PG 2 PG 3 PG 4 PG 5 PG 6 PG 7 Leather*</p>	<p>796 845 900 955 1 017 1 085 1 182 1 238 139 36</p>
	<p>Chair, medium back, 4 metal legs Base white (31) or black (37).</p> <p><i>*NB: Leather min. 2 chairs in same colour Upcharge for Bolster upholstery pg 1-7** Upcharge for base in chrome (13)</i></p>	<p>51 xx <b>20M01-xxx</b></p> <p>51 xx <b>20M0B-xxx</b></p> <p>51 13 <b>20M01-xxx</b></p>	<p>PG 1 PG 2 PG 3 PG 4 PG 5 PG 6 PG 7 Leather*</p>	<p>717 759 807 854 908 967 1 051 1 178 139 36</p>
	<p>Chair, high back 4 wooden legs in oak (03) or ash (06).</p> <p><i>*NB: Leather min. 2 chairs in same colour Upcharge for Bolster upholstery pg 1-7** Upcharge for stained legs; white oak (30), black ash (86), white ash (10), dark ash (76) Blue (D4).</i></p>	<p>51 xx <b>15H01-xxx</b></p> <p>51 xx <b>15H0B-xxx</b></p> <p>51 xx <b>15H01-xxx</b></p>	<p>PG 1 PG 2 PG 3 PG 4 PG 5 PG 6 PG 7 Leather*</p>	<p>910 958 1 013 1 069 1 130 1 198 1 296 1 352 139 76</p>
	<p>Chair, medium back 4 wooden legs in oak (03) or ash (06).</p> <p><i>*NB: Leather min. 2 chairs in same colour Upcharge for Bolster upholstery pg 1-7** Upcharge for stained legs; white oak (30), black ash (86), white ash (10), dark ash (76) Blue (D4).</i></p>	<p>51 xx <b>15M01-xxx</b></p> <p>51 xx <b>15M0B-xxx</b></p> <p>51 xx <b>15M01-xxx</b></p>	<p>PG 1 PG 2 PG 3 PG 4 PG 5 PG 6 PG 7 Leather*</p>	<p>842 884 932 980 1 033 1 092 1 177 1 303 139 76</p>



Illustration	Description	Article number	Price group	EUR
<b>Glove Bolster Cover</b> Design: Fredrik Mattson				
<p style="text-align: center;"><b>Glove BOLSTER COVER</b></p> <ul style="list-style-type: none"> <li>• Dressing fabric for Glove High and Medium.</li> <li>• Channel-sewn upholstery in fabrics from price group 1-7 with exception of artificial leather.</li> <li>• With zippers for easy mounting on existing chair.</li> <li>• For more product information see <a href="http://www.horreds.se">www.horreds.se</a></li> </ul>				
	<p>Dressing fabric for Glove High with steel stand</p> <p>Dressing fabric for Glove High with wooden stand</p> <p><i>Note: PG 1-7 excluding artificial leathers</i></p>	<p>51 BHS <b>-xxx</b></p> <p>51 BHT <b>-xxx</b></p>	<p>PG 1</p> <p>PG 2</p> <p>PG 3</p> <p>PG 4</p> <p>PG 5</p> <p>PG 6</p> <p>PG 7</p>	<p>365</p> <p>415</p> <p>465</p> <p>516</p> <p>574</p> <p>651</p> <p>767</p>
	<p>Dressing fabric for Glove Medium with steel stand</p> <p>Dressing fabric for Glove Medium with wooden stand</p> <p><i>Note: PG 1-7 excluding artificial leathers</i></p>	<p>51 BMS <b>-xxx</b></p> <p>51 BMT <b>-xxx</b></p>	<p>PG 1</p> <p>PG 2</p> <p>PG 3</p> <p>PG 4</p> <p>PG 5</p> <p>PG 6</p> <p>PG 7</p>	<p>342</p> <p>388</p> <p>433</p> <p>479</p> <p>532</p> <p>602</p> <p>707</p>




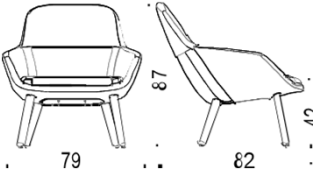

Illustration	Description	Article number	Price group	EUR
<p><b>Glove Lounge Design: Fredrik Mattson</b></p>  				
<p><b>Glove LOUNGEFÄTÖLJ</b></p> <ul style="list-style-type: none"> <li>Fully upholstered lounge chair, seat height 42cm, with cushion is fixed that is fixed with Velcro Tape.</li> <li>Model with wooden legs now also available in height 46cm</li> <li>Molded cold foam (HR) with metal frame.</li> <li>Upcharge for CMHR foam: € 129.</li> <li>Metal-reinforced wooden legs in oak. Clear lacquer or stain.</li> <li>4-vingat aluminiumstativ i polerat, svart (9005) and optional colours. See page 164 for more information about colours..</li> <li>For more product information, see <a href="http://www.horreds.se">www.horreds.se</a></li> </ul>				
	<p>Armchair with wooden legs. Black metal reinforcement. Oak (03) / Ash (06) Seating height 42 cm.</p>	<p>51 xx <b>10L01-xxx</b></p>	<p>PG 1 PG 2 PG 3 PG 4 PG 5 PG 6 PG 7 Leather</p>	<p>1 370 1 437 1 512 1 587 1 671 1 765 1 897 2 128</p>
	<p><i>Upcharge for seating height 46 cm</i></p> <p><i>Upcharge for stained legs; white oak (30), black ash (86), white ash (10), dark ash (76), ash Burgundy (C8), ash Conifer (D3) and ash Smokey Blue (D4).</i></p>	<p>51 xx <b>15L01-xxx</b> 51 xx <b>10L01-xxx</b></p>		<p>91 72</p>
	<p>Armchair with 4-wing aluminum stand with foot, rotatable and tilt. Black (37) / Polished (13)</p>	<p>51 xx <b>32L01-xxx</b></p>	<p>PG 1 PG 2 PG 3 PG 4 PG 5 PG 6 PG 7 Leather</p>	<p>1 568 1 630 1 700 1 771 1 849 1 936 2 060 2 274</p>
	<p><i>Upcharge for felt glides</i></p> <p><i>Upcharge for auto-return</i></p> <p><i>Upcharge optional colours stand</i></p> <p><i>Upcharge optional colours stand with auto-return</i></p>	<p>51 xx <b>32LF1-xxx</b> 51 xx <b>33L01-xxx</b> 51 yy <b>32L01-xxx</b> 51 yy <b>33L01-xxx</b></p>		<p>10 39 98 112</p>


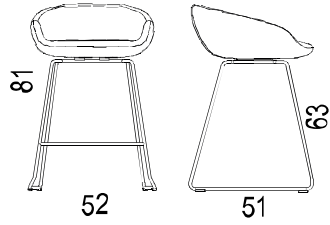
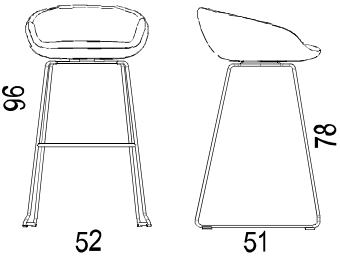
Illustration	Description	Article number	Price group	EUR
<p><b>Glove Bar</b> Design: Fredrik Mattson</p>				
	<p><b>Glove Bar</b></p> <ul style="list-style-type: none"> <li>Fully upholstered seat of molded cold foam (HR) with metal frame..</li> <li>Stand of 12 mm wire.</li> <li>Upcharge for CMHR-skum: € 30.</li> <li>For more product information see <a href="http://www.horreds.se">www.horreds.se</a></li> </ul> <p>Stand: Black RAL 9005 smooth gl.30 (37) (Other colours against quotation)</p>			
	<p>Bar stool with black stand, seating height 630 mm</p> <p>*NB:Leather min.2 pcs in same colour Upcharge for felt glides</p>	<p>51 37 <b>60B01-xxx</b></p> <p>51 37</p>	<p>PG 1 PG 2 PG 3 PG 4 PG 5 PG 6 PG 7 Leather*</p>	<p>575 599 626 654 684 718 766 1 009 10</p>
	<p>Bar stool with black stand, seating height 780 mm</p> <p>*NB:Leather min.2 pcs in same colour Upcharge for felt glides</p>	<p>51 37 <b>61B01-xxx</b></p> <p>51 37 <b>61BF1-xxx</b></p>	<p>PG 1 PG 2 PG 3 PG 4 PG 5 PG 6 PG 7 Leather*</p>	<p>628 653 680 707 738 772 820 1 063 10</p>




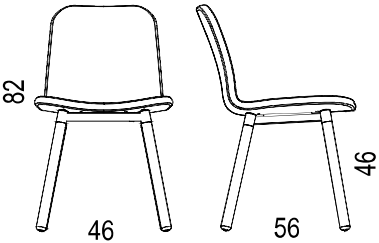
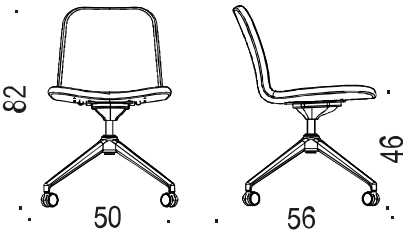
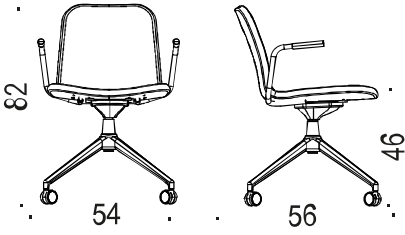
Illustration	Description	Article number	Price group	EUR
<b>Cuba</b>				
	<b>Cuba chair</b>			
	<ul style="list-style-type: none"> <li>Fully upholstered seat of molded plywood with cold foa</li> <li>Wooden legs in clear coated solid oak / ash are stande stained against upcharge:               <ol style="list-style-type: none"> <li>Oak; white pigmented</li> <li>Ash; white pigmented, black stained, dark stained Burgundy stain, Conifer stain and Smokey Blue stai</li> </ol> </li> <li>4-wing black aluminum stand (RAL9005) with/whitout castors.</li> <li>4-legged black (RAL 9005) steel.</li> <li>For more product information see <a href="http://www.horreds.se">www.horreds.se</a></li> </ul>			
				
	<p>Chair</p> <p>Wooden legs (cylindrical) in solid oak or ash, clear coated.</p> <p>Seating height 46cm</p> <p>Frame in metal, black RAL 9005</p> <p>Oak (03), Ash (06)</p> <p>*NB: Leather min.4 pcs in same colour</p> <p><i>Upcharge for stained legs</i></p>	<p>34 xx <b>1537-xxx</b></p> <p>34 xx <b>1037-xxx</b></p>	<p>PG 1</p> <p>PG 2</p> <p>PG 3</p> <p>PG 4</p> <p>PG 5</p> <p>PG 6</p> <p>PG 7</p> <p>Leather*</p>	<p>467</p> <p>486</p> <p>508</p> <p>530</p> <p>554</p> <p>581</p> <p>620</p> <p>707</p> <p>72</p>
	<p>Chair</p> <p>4-wing aluminum stand, with castors, fixed height, tilt, swivel.</p> <p>Seating height 46cm</p> <p>Black RAL 9005</p> <p>*NB: Leather min.4 pcs in same colour</p> <p><i>Upcharge for height adj. 42-52 cm</i></p> <p><i>Upcharge for interval braked wheels</i></p>	<p>34 37 <b>30-xxx</b></p> <p>34 37 <b>34-xxx</b></p> <p>34 37 <b>30I-xxx</b></p>	<p>PG 1</p> <p>PG 2</p> <p>PG 3</p> <p>PG 4</p> <p>PG 5</p> <p>PG 6</p> <p>PG 7</p> <p>Leather*</p>	<p>552</p> <p>572</p> <p>595</p> <p>618</p> <p>643</p> <p>671</p> <p>712</p> <p>803</p> <p>25</p> <p>27</p>
	<p>Armchair</p> <p>4-wing aluminum stand, with castors, fixed height, tilt, swivel.</p> <p>Seating height 46cm</p> <p>Black RAL 9005</p> <p>*NB: Leather min.4 pcs in same colour</p> <p><i>Upcharge for height adj. 42-52 cm</i></p> <p><i>Upcharge for interval braked wheels</i></p>	<p>34 37 <b>31-xxx</b></p> <p>34 37 <b>35-xxx</b></p> <p>34 37 <b>31I-xxx</b></p>	<p>PG 1</p> <p>PG 2</p> <p>PG 3</p> <p>PG 4</p> <p>PG 5</p> <p>PG 6</p> <p>PG 7</p> <p>Leather*</p>	<p>662</p> <p>683</p> <p>705</p> <p>728</p> <p>754</p> <p>782</p> <p>823</p> <p>914</p> <p>25</p> <p>27</p>



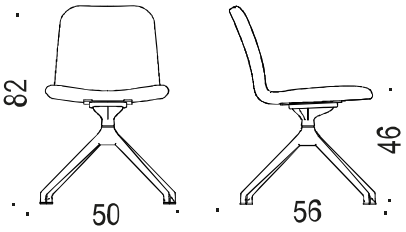
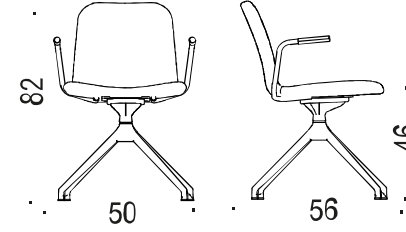
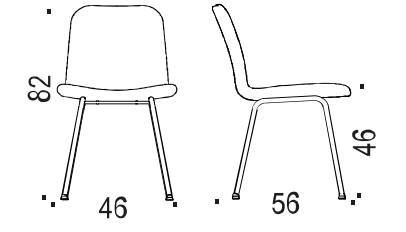
Illustration	Description	Article number	Price group	EUR
	<p>Chair 4-wing aluminum stand, with glides, fixed height, tilt, swivel. Seating height 46cm <i>Black RAL 9005</i></p> <p><i>*NB: Leather min.4 pcs in same colour</i> <i>Upcharge for felt glides</i></p>	<p>34 37 <b>32-xxx</b></p> <p>34 37 <b>32F-xxx</b></p>	<p>PG 1 PG 2 PG 3 PG 4 PG 5 PG 6 PG 7 Leather*</p>	<p>552 572 595 618 643 671 712 803 11</p>
	<p>Armchair 4-wing aluminum stand, with glides, fixed height, tilt, swivel. Seating height 46cm <i>Black RAL 9005</i></p> <p><i>*NB: Leather min.4 pcs in same colour</i> <i>Upcharge for felt glides</i></p>	<p>34 37 <b>33-xxx</b></p> <p>34 37 <b>33F-xxx</b></p>	<p>PG 1 PG 2 PG 3 PG 4 PG 5 PG 6 PG 7 Leather*</p>	<p>662 683 705 728 754 782 823 914 11</p>
	<p>Chair 4-legged steel RAL9005 Seating height 46cm</p> <p><i>*NB: Leather min.4 pcs in same colour</i> <i>Upcharge for sliding feet with felt</i></p>	<p>34 37 <b>20-xxx</b></p> <p>34 37 <b>20F-xxx</b></p>	<p>PG 1 PG 2 PG 3 PG 4 PG 5 PG 6 PG 7 Leather*</p>	<p>0 332 352 373 395 420 447 485 572 11</p>




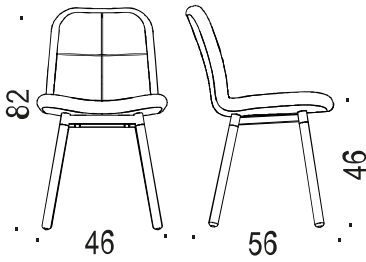
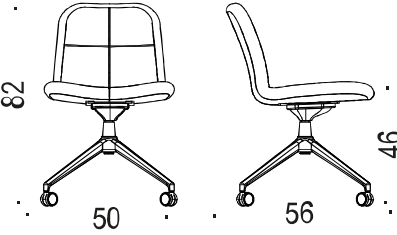
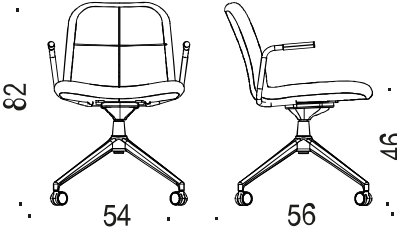

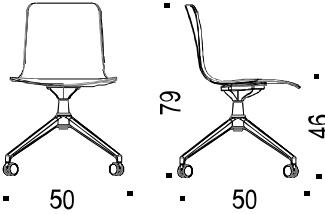

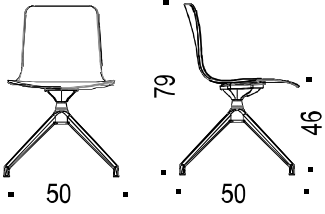
Illustration	Description	Article number	Price group	EUR
<h2>Cuba quiltad</h2>		 <b>MÖBELFAKTA</b>		
	<h3>Cuba, quilted</h3> <ul style="list-style-type: none"> <li>Fully upholstered seat of molded plywood with cold foam. Quilted upholstery which is replaceable.</li> <li>Wooden legs in clear coated solid oak and ash. Stained legs against upcharge:                             <ol style="list-style-type: none"> <li>Oak; white pigmented</li> <li>Ash; white pigmented, black stained, dark stained Burgundy stain, Conifer stain and Smokey Blue stain.</li> </ol> </li> <li>4-wing black (RAL 9005) aluminum stand, with/without castors. Other colours on request.</li> <li>4-legged black (RAL 9005) steel.</li> <li>For more product information see <a href="http://www.horreds.se">www.horreds.se</a></li> </ul>			
	<p>Chair with quilted upholstery. Wooden legs (cylindrical) in solid oak (03) or ash (06). Clear coated. Seating height 46cm Frame in metal black RAL 9005</p> <p>*: Leather min 4 pcs in same colour <i>Upcharge for stained legs</i></p>	<p>34Q xx 1537-xxx</p> <p>34Q xx 1537-xxx</p>	<p>PG 1 PG 2 PG 3 PG 4 PG 5 PG 6 PG 7 Leather*</p>	<p>524 549 577 605 637 673 725 827 72</p>
	<p>Chair with quilted upholstery. 4-wing aluminum stand w. castors. Fixed height, tilt, rotation. Seating height 46cm Black RAL 9005</p> <p>*NB:Leather min.4 pcs in same colour</p> <p><i>Upcharge for height adj. 42-52cm</i> <i>Upcharge for interval braked castors</i></p>	<p>34Q 37 30-xxx</p> <p>34Q 37 34-xxx</p> <p>34Q 37 30I-xxx</p>	<p>PG 1 PG 2 PG 3 PG 4 PG 5 PG 6 PG 7 Leather*</p>	<p>609 635 664 693 725 763 817 923 25 27</p>
	<p>Armhair with quilted upholstery. 4-wing aluminum stand w. castors. Fixed height, tilt, rotation. Seating height 46cm Black RAL 9005</p> <p>*NB:Leather min.4 pcs in same colour</p> <p><i>Upcharge for height adj. 42-52cm</i> <i>Upcharge for interval braked castors</i></p>	<p>34Q 37 31-xxx</p> <p>34Q 37 35-xxx</p> <p>34Q 37 31I-xxx</p>	<p>PG 1 PG 2 PG 3 PG 4 PG 5 PG 6 PG 7 Leather*</p>	<p>719 746 775 804 836 874 928 1 034 25 27</p>

Illustration	Description	Article number	Price group	EUR
	<p>Chair with quilted upholstery 4-wing aluminum stand with sliding feet, fixed height, tilt, rotation. Seating height 46cm Black RAL 9005</p> <p>*: Leather min.4 pcs in same colour <i>Upcharge for sliding feet with felt</i></p>	<p>34Q 37 32-xxx</p> <p>34Q 37 32F-xxx</p>	<p>PG 1 PG 2 PG 3 PG 4 PG 5 PG 6 PG 7 Leather*</p>	<p>609 635 664 693 725 763 817 923 11</p>
	<p>Armchair with quilted upholstery 4-wing aluminum stand with sliding feet, fixed height, tilt, rotation. Seating height 46cm Black RAL 9005</p> <p>*: Leather min.4 pcs in same colour <i>Upcharge for sliding feet with felt</i></p>	<p>34Q 37 33-xxx</p> <p>34Q 37 33F-xxx</p>	<p>PG 1 PG 2 PG 3 PG 4 PG 5 PG 6 PG 7 Leather*</p>	<p>719 746 775 804 836 874 928 1 034 11</p>
	<p>Chair with quilted upholstery 4-legged steel RAL9005 Seating height 46cm</p> <p>*: Leather min.4 pcs in same colour <i>Upcharge for sliding feet with felt</i></p>	<p>34Q 37 20-xxx</p> <p>34Q 37 20F-xxx</p>	<p>PG 1 PG 2 PG 3 PG 4 PG 5 PG 6 PG 7 Leather*</p>	<p>389 415 443 470 502 538 591 692 11</p>

Illustration	Description	Article number	Price group	EUR	Pris
<b>Base Design: Anderssen &amp; Voll</b>					
	<p><b>Base med 4-vingat hjulstativ</b></p> <ul style="list-style-type: none"> <li>• ChaiR with pressed seat shell.</li> <li>• Fully upholstered. Padding of cold foam (CMHR).</li> <li>• Thicker upholstery as option.</li> <li>• 4-winged aluminum base with castors and tilt function.</li> <li>• Castors with polyurethane roller conveyor, suitable for all floors.</li> <li>• Price for leather chairs in less than 4 pieces: against quotation</li> <li>• För mer produktinformation se <a href="http://www.horreds.se">www.horreds.se</a></li> </ul> <p><u>Colours stands (xx):</u> 37 Black (RAL 9005) 13 Polished (against upcharge) NB: Model A60 only. <i>(Aother RAL colours against quotation)</i></p>				
	<p>Chair, 4-winged black aluminum stand with castors, fixed height, tilt, fully upholstered</p> <p>*Note:Leather min 4 pcs in same colour</p> <p><i>Upcharge for thicker upholstery</i> <i>Upcharge for polished stand</i></p>	<p>65 <b>A60</b> xx 97-xxx 65 <b>A60</b> xx 97-xxx 65 <b>A60</b> xx 97-xxx 65 <b>A60</b> xx 97-xxx 65 <b>A60</b> xx 97-xxx 65 <b>A60</b> xx 97-xxx 65 <b>A60</b> xx 97-xxx 65 <b>A60</b> xx 97-xxx 65 <b>A60</b> xx 97-xxx 65 <b>B61</b> xx 97-xxx 65 <b>A60</b> 13 97-xxx</p>	<p>PG 1 PG 2 PG 3 PG 4 PG 5 PG 6 PG 7 Leather*</p>	<p>679 703 730 757 787 821 868 976 59 44</p>	
<b>Base 4-wing leg stand</b>					
	<ul style="list-style-type: none"> <li>• Chair with pressed seat shell.</li> <li>• Fully upholstered.Padding of cold foam (CMHR).</li> <li>• Thicker upholstery as option.</li> <li>• 4-winged aluminum base with tilt function.</li> <li>• Upcharge for felt glides.</li> <li>• Price for leather chairs in less than 4 pieces: against quotation</li> <li>• Fore more information, see <a href="http://www.horreds.se">www.horreds.se</a></li> </ul> <p><u>Colours stands (xx):</u> 37 Black (RAL 9005) 13 Polished (against upcharge) <i>(Aother RAL colours against quotation)</i></p>				
	<p>Chair, 4-winged black aluminum stand <b>without</b> castors, fixed height, tilt, fully upholstered</p> <p>*Note:Leather min 4 pcs in same colour</p> <p><i>Upcharge for thicker upholstery</i> <i>Upcharge for polished stand</i> <i>Upcharge for sliding feet with felt</i></p>	<p>65 <b>A62</b> xx 97-xxx 65 <b>A62</b> xx 97-xxx 65 <b>A62</b> xx 97-xxx 65 <b>A62</b> xx 97-xxx 65 <b>A62</b> xx 97-xxx 65 <b>A62</b> xx 97-xxx 65 <b>A62</b> xx 97-xxx 65 <b>A62</b> xx 97-xxx 65 <b>A62</b> xx 97-xxx 65 <b>B62</b> xx 97-xxx 65 <b>A62</b> 13 97-xxx</p>	<p>Prisgrupp 1 Prisgrupp 2 Prisgrupp 3 Prisgrupp 4 Prisgrupp 5 Prisgrupp 6 Prisgrupp 7 Läder*</p>	<p>679 703 730 757 787 821 868 976 59 44 12</p>	

**Base** Design: Anderssen & Voll



**Base med 5-vingat hjulstativ**

- Chair with pressed seat shell
- Fully upholstered. Padding of cold foam (CMHR).
- Kanalsydd klädsel mot tillägg
- Castors with polyurethane roller conveyor, suitable for all floors.
- Thicker upholstery as option.
- Price for leather chairs in less than 4 pieces: against quotation
- Fore more information, see [www.horreds.se](http://www.horreds.se)

Colours stands (xx):

37 Black (RAL 9005)

*(Aother RAL colours against quotation*

	<p>Chair, 5-wing black stand with castors, fixed height, tilt, fully upholstered.</p>	<p>65 <b>A50</b> 37 97-xxx                  65 <b>A50</b> 37 97-xxx                  65 <b>A50</b> 37 97-xxx                  65 <b>A50</b> 37 97-xxx                  65 <b>A50</b> 37 97-xxx                  65 <b>A50</b> 37 97-xxx                  65 <b>A50</b> 37 97-xxx                  65 <b>A50</b> 37 97-xxx</p>	<p>PG 1                  PG 2                  PG 3                  PG 4                  PG 5                  PG 6                  PG 7                  Leather*</p>	<p>794                  818                  845                  872                  902                  935                  983                  1 091</p>
	<p>*NB: Leather min. 4 chairs in same colour</p>			
	<p><i>Upcharge for adjustable height 44-53 cm</i></p>	<p>65 <b>A52</b> 37 97-xxx</p>		<p>29</p>
	<p><i>Upcharge for interval braked castors</i></p>	<p>65 <b>xxx</b> 37 97-xxx</p>		<p>28</p>
	<p><i>Upcharge for thicker upholstery</i></p>	<p>65 <b>B50</b> 37 97-xxx</p>		<p>59</p>

**Base Design: Anderssen & Voll**



**Base med 4-bent stativ**

- Stackable chair / armchair with pressed seat shell.
- Fully upholstered. Stopping in cold foam.
- Veneered in clear coated oak and dark stained ash.
- Stack protection in felt for upholstered chairs.
- Recommended stacking height: max 8 charis.
- Connectable in version without upholstery.
- Stand of 19 mm steel pipe, black TPE armrests, black plastic feet.
- Price for leather chairs in less than 4 pieces; against quotation.
- For more product information; see [www.horreds.se](http://www.horreds.se)

Colour stands (xx):

37 Black (RAL 9005)

13 Chrome: Models A11 and A10 only

(Other RAL colours against quotation)

	<p>Chair with upholstered seat shell, Incl stack protection in felt, black or chrome</p> <p>*Note:Leather min.4 chairs in same color</p> <p><i>Upcharge for sliding feet with felt</i> <i>Upcharge for thicker upholstery</i></p>	<p>65 <b>A11</b> xx 97-xxx 65 <b>A11</b> xx 97-xxx 65 <b>A11</b> xx 97-xxx 65 <b>A11</b> xx 97-xxx 65 <b>A11</b> xx 97-xxx 65 <b>A11</b> xx 97-xxx 65 <b>A11</b> xx 97-xxx 65 <b>A11</b> xx 97-xxx 65 <b>A11</b> xx 97-xxx 65 <b>A11</b> xx 97-xxx 65 <b>A11</b> xx 97-xxx 65 <b>A11</b> xx 97-xxx 65 <b>A11</b> xx 97-xxx 65 <b>A11</b> xx 97-xxx 65 <b>B11</b> xx 97-xxx</p>	<p>PG 1 PG 2 PG 3 PG 4 PG 5 PG 6 PG 7 Leather*</p>	<p>566 590 617 644 674 707 755 863  29 59</p>
	<p>Armchair with upholstered seat shell, Incl stack protection in felt, black. Black stand</p> <p>*Note: Leather min.4 chairs in same color</p> <p><i>Upcharge for sliding feet with felt</i> <i>Upcharge for thicker upholstery</i></p>	<p>65 <b>A21</b> 37 97-xxx 65 <b>A21</b> 37 97-xxx 65 <b>A21</b> 37 97-xxx 65 <b>A21</b> 37 97-xxx 65 <b>A21</b> 37 97-xxx 65 <b>A21</b> 37 97-xxx 65 <b>A21</b> 37 97-xxx 65 <b>A21</b> 37 97-xxx 65 <b>A21</b> 37 97-xxx 65 <b>A21</b> 37 97-xxx 65 <b>A21</b> 37 97-xxx 65 <b>A21</b> 37 97-xxx 65 <b>A21</b> 37 97-xxx 65 <b>A21</b> 37 97-xxx 65 <b>A21</b> 37 97-xxx 65 <b>B21</b> 37 97-xxx</p>	<p>PG 1 PG 2 PG 3 PG 4 PG 5 PG 6 PG 7 Leather*</p>	<p>752 775 802 829 860 893 941 1 049  29 59</p>
	<p>Chair with veneered seat shell, black or chrome</p> <p><i>Upcharge for connecting fittings</i> <i>Upcharge for sliding feet with felt</i></p>	<p>65 <b>A10</b> xx 03 65 <b>A10</b> xx 76  65 <b>A12</b> xx xx 65 <b>A10</b> xx xxF</p>	<p>Oak Dark ash</p>	<p>396 396  64 29</p>
	<p>Armchair with veneered seat shell, black.</p> <p><i>Upcharge for connecting fittings</i> <i>Upcharge for sliding feet with felt</i></p>	<p>65 <b>A20</b> 37 03 65 <b>A20</b> 37 76  65 <b>A22</b> 37 xx 65 <b>A22</b> 37 xxF</p>	<p>Oak Dark ash</p>	<p>583 583  64 29</p>

**Base** Design: Anderssen & Voll

**Base with sled base**



- Stackable chair with pressed seat shell
- Fully upholstered. Stopping in cold foam
- Veneered in oak nature and dark stained ash
- Sled base of 12 mm wire
- Stack protection in felt for upholstered chairs.
- Connectable
- Price for leather chairs in less than 4 pieces: against quotation
- For more product information: see [www.horreds.se](http://www.horreds.se)

Colour stands (xx):

37 Black (RAL 9005)

(Other RAL colours against quotation)

	<p>Chair with black sled base, fully upholstered</p> <p>*NB: Leather min.4 chairs in same colour</p> <p><i>Upcharge for thicker upholstery</i></p> <p><i>Upcharge for sliding feet with felt</i></p> <p><i>Upcharge cost for connecting fittings</i></p>	<p>65 <b>A40</b> 37 97-xxx</p> <p>65 <b>A40</b> 37 97-xxx</p> <p>65 <b>A40</b> 37 97-xxx</p> <p>65 <b>A40</b> 37 97-xxx</p> <p>65 <b>A40</b> 37 97-xxx</p> <p>65 <b>A40</b> 37 97-xxx</p> <p>65 <b>A40</b> 37 97-xxx</p> <p>65 <b>A40</b> 37 97-xxx</p> <p>65 <b>A40</b> 37 97-xxx</p> <p>65 <b>B40</b> 37 97-xxx</p> <p>65 <b>A40</b> 37 97-Fxxx</p> <p>65 <b>A42</b> 37 97-xxx</p>	<p>PG 1</p> <p>PG 2</p> <p>PG 3</p> <p>PG 4</p> <p>PG 5</p> <p>PG 6</p> <p>PG 7</p> <p>Leather*</p>	<p>490</p> <p>514</p> <p>541</p> <p>568</p> <p>598</p> <p>631</p> <p>679</p> <p>787</p> <p>59</p> <p>12</p> <p>17</p>
	<p>Chair with black sled base, veneered seat shell</p> <p><i>Upcharge for sliding feet with felt</i></p> <p><i>Upcharge cost for connecting fittings</i></p>	<p>65 <b>A40</b> 37 03</p> <p>65 <b>A40</b> 37 76</p> <p>65 <b>A40</b> 37 xxF</p> <p>65 <b>A42</b> 37 xx</p>	<p>Oak</p> <p>Dark ash</p>	<p>329</p> <p>329</p> <p>12</p> <p>17</p>



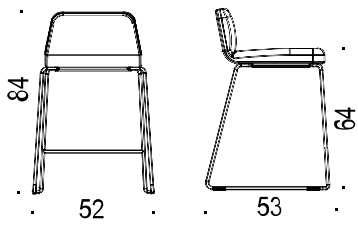
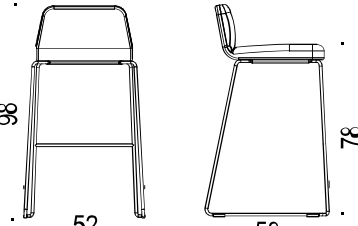
Illustration	Description	Article number	Price group	EUR
<p><b>VX Bar stool</b></p>				
	<p><b>VX BAR STOOL</b></p> <ul style="list-style-type: none"> <li>• Upholstered seat of molded plywood with cold foam</li> <li>• Stand of 12 mm wire, stackable 4 pcs</li> <li>• Stack protection in molded felt (anthracite gray)</li> <li>• For more product information; see <a href="http://www.horreds.se">www.horreds.se</a></li> </ul> <p style="text-align: center;"><u>Stand:</u> Black RAL 9005 str (37) Chrome (13) <i>Other colour against quotation</i></p>			
	<p>Bar stool, seat height 640 mm</p> <p>*NB: Leather min. 2 chairs in same colour</p> <p><i>Upcharge for chrome</i></p> <p><i>Upcharge for sliding feet with felt</i></p>	<p>34 xx <b>07290-xxx</b></p> <p>34 13 <b>07290-xxx</b></p> <p>34 xx <b>07290Fxxx</b></p>	<p>PG 1</p> <p>PG 2</p> <p>PG 3</p> <p>PG 4</p> <p>PG 5</p> <p>PG 6</p> <p>PG 7</p> <p>Leather*</p>	<p>476</p> <p>500</p> <p>527</p> <p>554</p> <p>584</p> <p>617</p> <p>665</p> <p>903</p> <p>47</p> <p>12</p>
	<p>Bar stool, seat height 780 mm</p> <p>*NB: Leather min. 2 chairs in same colour</p> <p><i>Upcharge for chrome</i></p> <p><i>Upcharge for sliding feet with felt</i></p>	<p>34 xx <b>07295-xxx</b></p> <p>34 13 <b>07295-xxx</b></p> <p>34 xx <b>07295Fxxx</b></p>	<p>PG 1</p> <p>PG 2</p> <p>PG 3</p> <p>PG 4</p> <p>PG 5</p> <p>PG 6</p> <p>PG 7</p> <p>Leather*</p>	<p>496</p> <p>519</p> <p>547</p> <p>573</p> <p>604</p> <p>637</p> <p>684</p> <p>922</p> <p>47</p> <p>12</p>




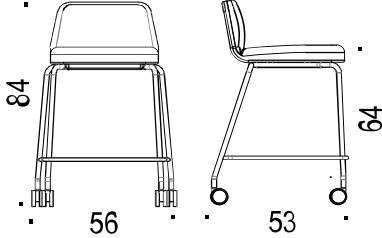


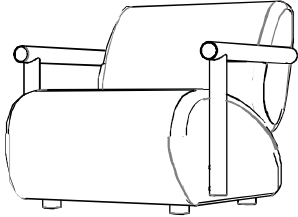
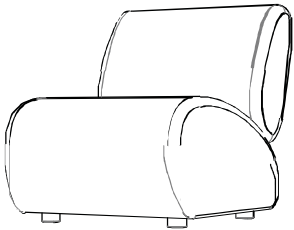
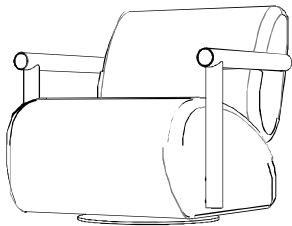
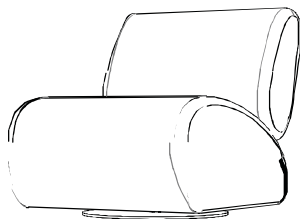
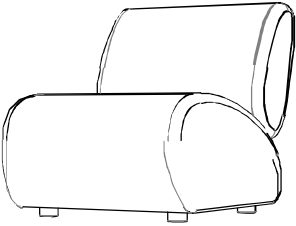
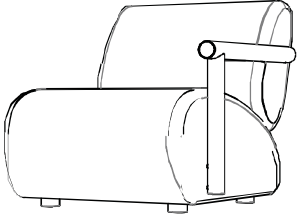
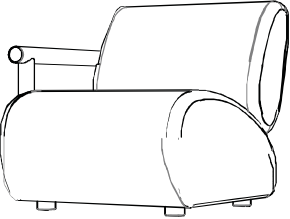
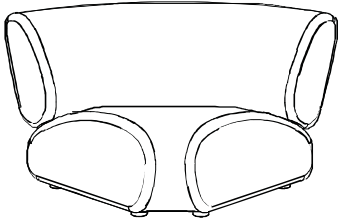
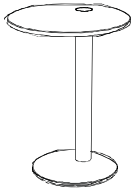
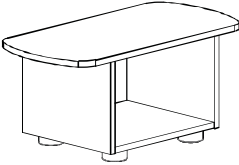
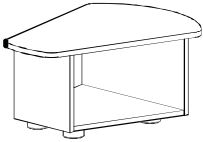
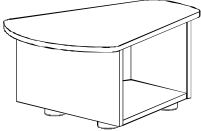
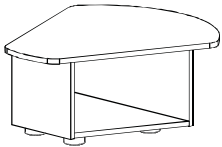
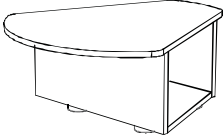
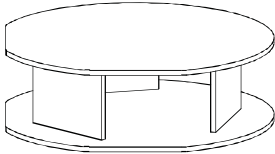
Illustration	Description	Article number	Price group	EUR
<b>VX Bar stool with castors</b>				
	<p><b>VX Bar stool with castors</b></p> <ul style="list-style-type: none"> <li>• Upholstered seat of molded plywood with cold foam.</li> <li>• Stand made of 19mm steel tube, footrest made of 14mm wire..</li> <li>• Interval braked castors, polyurethane roller track, suitable for all floors.</li> <li>• Stack coverin molded felt, anthracite grey.</li> <li>• or more product information see <a href="http://www.horreds.se">www.horreds.se</a></li> </ul> <p style="text-align: center;"><u>Colour stand:</u> Black RAL 9005 (37) (Other colours on request)</p>			
	<p>4-legged with castors, black, seat height 640 mm</p> <p>*NB: Leather minimum number 2 pcs in the same colour.</p>	<p>34 37 <b>08993-xxx</b></p>	<p>PG 1 PG 2 PG 3 PG 4 PG 5 PG 6 PG 7 Leather*</p>	<p>532 556 583 610 640 673 720 959</p>

Illustration	Description	Article number	Price group	EUR
<b>LOG Design: Studio Stockholm Arkitektur</b>				
<p><b>LOG Fåtölj / Modulsoffa</b></p>  <ul style="list-style-type: none"> <li>• Fully upholstered modular sofa with a seat height of 41 cm.</li> <li>• Wood and metal frame with HR foam.</li> <li>• CMHR foam upcharge € 144 / seating module.</li> <li>• Legs in solid oak, height 30mm.</li> <li>• For different fabrics in the seat and back, the price of the higher fabric group plus an upcharge of € 60 applies.</li> <li>• Coupling fittings to be ordered separately.</li> <li>• Leather modules against quotation</li> <li>• For more product information see <a href="http://www.horreds.se">www.horreds.se</a></li> </ul> 				
<b>Armchairs</b>				
	<p>Armchair with feet and armrests in hard vax oiled oak (D5) or black stained oak (73).</p> <ul style="list-style-type: none"> <li>• Width 77cm</li> <li>• Height 74cm (height armrests 56cm)</li> <li>• Depth 85cm</li> <li>• Seat height 41c,</li> </ul> <p>Can not be coupled</p>	27 xx <b>202-xxx</b>	PG 1 PG 2 PG 3 PG 4 PG 5 PG 6 PG 7	2 098 2 175 2 251 2 326 2 414 2 531 2 706
	<p>Armstir with feet in hard vax oiled oak (D5) or black stained oak 73)</p> <ul style="list-style-type: none"> <li>• Width 65cm</li> <li>• Height 74cm</li> <li>• Depth 85cm</li> <li>• Seat height 41cm</li> </ul>	27 xx <b>200-xxx</b>	PG 1 PG 2 PG 3 PG 4 PG 5 PG 6 PG 7	1 458 1 534 1 610 1 685 1 773 1 890 2 065
	<p>Armchair swivel with auto return.</p> <p>With armrest in hard vax oiled oak (D5) or blackstained oak (73). Black footplate.</p> <ul style="list-style-type: none"> <li>• Width 770mm</li> <li>• Height 740mm (höjd armstöd 565mm)</li> <li>• Depth 850mm</li> <li>• Seat height 410mm</li> </ul> <p>Can not be coupled</p>	27 xx <b>10202-xxx</b>	PG 1 PG 2 PG 3 PG 4 PG 5 PG 6 PG 7	2 493 2 569 2 646 2 721 2 809 2 926 3 101
	<p>Armchair swivel with auto return.</p> <p>Black footplate.</p> <ul style="list-style-type: none"> <li>• Width 65cm</li> <li>• Height 74cm</li> <li>• Depth 85cm</li> <li>• Seat height 41cm</li> </ul> <p>Can not be coupled</p>	27 00 <b>10200-xxx</b>	PG 1 PG 2 PG 3 PG 4 PG 5 PG 6 PG 7	1 853 1 929 2 005 2 080 2 168 2 285 2 460

	Modular sofa			
	<p>Seating module with back. Feet in hard vax oiled oak (D5) or black stained oak (73)</p> <ul style="list-style-type: none"> <li>• Width 65cm</li> <li>• Height 74cm</li> <li>• Depth 85cm</li> <li>• Seat height 41cm</li> </ul> <p>Coupling fitting</p>	27 xx <b>200-xxx</b>	PG 1 PG 2 PG 3 PG 4 PG 5 PG 6 PG 7	1 458 1 534 1 610 1 685 1 773 1 890 2 065 23
	<p>Seating module with back, armrest left side. Feet and armrest in hard vax oiled oak (D5) or black stained oak (73)</p> <ul style="list-style-type: none"> <li>• Width 71cm</li> <li>• Height 74cm,(height armrests 56cm)</li> <li>• Depth 85cm</li> <li>• Seat height 41cm</li> </ul> <p>Coupling fitting</p>	27 xx <b>201-xxx</b>	PG 1 PG 2 PG 3 PG 4 PG 5 PG 6 PG 7	1 778 1 854 1 930 2 006 2 094 2 210 2 386 23
	<p>Seating module with back, armrest right side. Feet and armrest in hard vax oiled oak (D5) or black stained oak (73)</p> <ul style="list-style-type: none"> <li>• Width 71cm</li> <li>• Height 74cm(height armrests 56cm)</li> <li>• Depth 85cm</li> <li>• Seat height 41cm</li> </ul> <p>Coupling fitting</p>	27 xx <b>203-xxx</b>	PG 1 PG 2 PG 3 PG 4 PG 5 PG 6 PG 7	1 778 1 854 1 930 2 006 2 094 2 210 2 386 23
	<p>Corner module w. back. Feet in hard vax oiled oak (D5) or black stained oak (73).</p> <ul style="list-style-type: none"> <li>• Width 95cm</li> <li>• Height 74cm</li> <li>• Depth 95cm</li> <li>• Seat height 41cm</li> </ul> <p>Coupling fittings (1/joint)</p> <p>Note: connect to seat modules, not against coupling modules.</p>	27 xx <b>300-xxx</b>	PG 1 PG 2 PG 3 PG 4 PG 5 PG 6 PG 7	2 265 2 373 2 481 2 588 2 714 2 879 3 129 23
	<p>Laptop table. Top, leg and foot in hard vax oiled oak or black stained oak. Black metal parts.</p> <ul style="list-style-type: none"> <li>• Height 60cm</li> <li>• Top Ø40cm</li> <li>• Foot Ø30cm</li> </ul>	27 D5 <b>09245</b> 27 73 <b>09245</b>	Vax oiled Black stain	800 800

<h3 style="text-align: center;">Kopplingsmoduler</h3> <ul style="list-style-type: none"> <li>• Coupling modules in hard vax oiled oak or black stained oak.</li> <li>• Height 29cm.</li> <li>• For connection between 2 seating modules.</li> <li>• Not intended as stand-alone modules</li> <li>• Electrical outlet as an option</li> </ul>				
	Table connection, straight, in hard vax oiled oak or black stained oak. Height 29cm.	27 D5 <b>09130</b> 27 73 <b>09130</b>	Vax oiled Black stain	545 545
	Same as above but with hole for 1 power outlet at the front	27 D5 <b>09130K</b> 27 73 <b>09130K</b>	Vax oiled Black stain	545 545
	Coupling fittings (1/joint)	<b>27001</b>		23
	Table coupling, 30° inside, in hard vax oiled oak or black stained oak. Height 29cm.	27 D5 <b>09135I</b> 27 73 <b>09135I</b>	Vax oiled Black stain	653 653
	Same as above but with hole for 1 power outlet at the front	27 D5 <b>09135IK</b> 27 73 <b>09135IK</b>	Vax oiled Black stain	653 653
	Table coupling, 30° outside, in hard vax oiled oak or black stained oak. Height 29cm.	27 D5 <b>09135U</b> 27 73 <b>09135U</b>	Vax oiled Black stain	653 653
	Same as above but with hole for 1 power outlet at the front	27 D5 <b>09135UK</b> 27 73 <b>09135UK</b>	Vax oiled Black stain	653 653
	Table coupling, 45° inside, in hard vax oiled oak or black stained oak. Height 29cm.	27 D5 <b>09140I</b> 27 73 <b>09140I</b>	Vax oiled Black stain	690 690
	Same as above but with hole for 1 power outlet at the front	27 D5 <b>09140IK</b> 27 73 <b>09140I</b>	Vax oiled Black stain	690 690
	Table coupling, 45° outside, in hard vax oiled oak or black stained oak. Height 29cm.	27 D5 <b>09140U</b> 27 73 <b>09140U</b>	Vax oiled Black stain	690 690
	Same as above but with hole for 1 power outlet at the front	27 D5 <b>09140UK</b> 27 73 <b>09140UK</b>	Vax oiled Black stain	690 690
	Table coupling, corner 90°, in hard vax oiled oak or black stained oak. Height 29cm. (not available with power outlet)	27 D5 <b>09125</b> 27 73 <b>09125</b>	Vax oiled Black stain	775 775
	Coupling fittings (1/joint)	<b>27001</b>		23

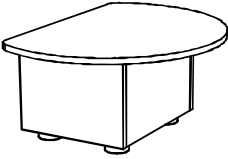
	Table coupling / final module in hard wax oiled oak or black stained oak .Height 29cm. Connects to straight seating module (not corner module). Width 45cm, height 29cm.	27 D5 <b>09185</b> 27 73 <b>09185</b>	Vax oiled Black stain	576 576
	Same as above but with hole for 1 power outlet left side	27 D5 <b>09185KV</b> 27 73 <b>09185KV</b>	Vax oiled Black stain	576 576
	Same as above but with hole for 1 power outlet right side	27 D5 <b>09185KH</b> 27 73 <b>09185KH</b>	Vax oiled Black stain	576 576
	Kopplingsbeslag (1/skarv)	<b>27001</b>		23
	<b>Power outlets to coupling modules</b>			
	Powerdot 1 x power incl cable entry 51 mm	935 <b>-PM50</b> 935 <b>-PM50W</b>	Black White	63 63
	Powerdot 2 x USB-C PD charger incl cable entry 51 mm	935 <b>-PM52</b> 935 <b>-PM52W</b>	Black White	144 144


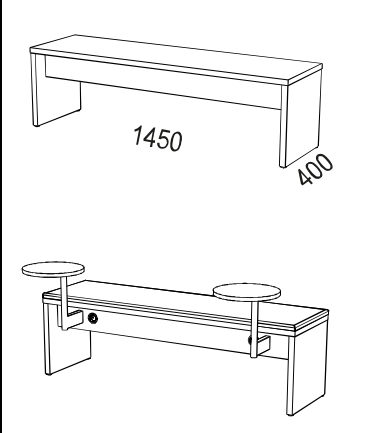
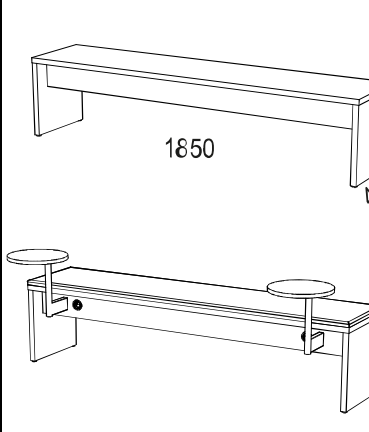
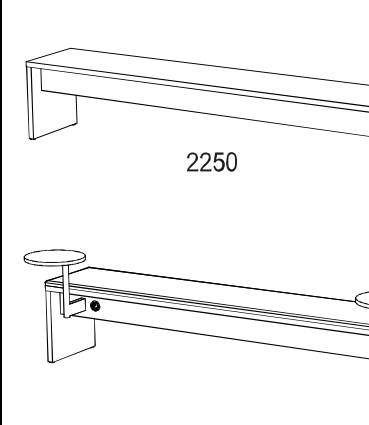
Illustration	Description	Article number	Price group	EUR																																												
<b>Nomono Bench</b> Design: Fredrik Mattson																																																
	<p><b>Nomono BENCH</b></p> <ul style="list-style-type: none"> <li>Nomono Bench is made from 28mm mdf slat.</li> <li>90 degree corners with straight, matching edge.</li> <li>Material: Oak (03) White oak (30) Burgundy stained ash (C8) Ash (06) White ash (10) Conifer stained ash (D3) Black st. ash (86) Smokey Blue stained ash (D4) Dark st. ash (76)</li> <li>Available in 3 lengths; 1450mm, 1850mm, 2250mm</li> <li>Optional: upholstered seat cushion</li> <li>Seat height in veneered version 450 mm, Seat height with upholstered cushion 460mm.</li> <li>Djup 400mm</li> <li>Table and / or electrical outlet as an option.</li> <li>Delivered unassembled.</li> <li>For more product information see <a href="http://www.horreds.se">www.horreds.se</a></li> </ul>																																															
	<p><b>Längd 1450mm</b></p> <p>Oak, ash, stained oak / ash</p> <p>With upholstered seat cushion</p> <table border="1"> <tr><td>53 xx</td><td><b>0145D</b></td><td>Veneered seat</td><td>1 357</td></tr> <tr><td>53 xx</td><td><b>0145A-x</b></td><td>Price group 1</td><td>1 443</td></tr> <tr><td>53 xx</td><td><b>0145A-x</b></td><td>Price group 2</td><td>1 473</td></tr> <tr><td>53 xx</td><td><b>0145A-x</b></td><td>Price group 3</td><td>1 505</td></tr> <tr><td>53 xx</td><td><b>0145A-x</b></td><td>Price group 4</td><td>1 538</td></tr> <tr><td>53 xx</td><td><b>0145A-x</b></td><td>Price group 5</td><td>1 576</td></tr> <tr><td>53 xx</td><td><b>0145A-x</b></td><td>Price group 6</td><td>1 627</td></tr> <tr><td>53 xx</td><td><b>0145A-x</b></td><td>Price group 7</td><td>1 699</td></tr> <tr><td>53 xx</td><td><b>0145A-x</b></td><td>Leather*</td><td>1 871</td></tr> <tr><td>53 xx</td><td><b>z145z-x</b></td><td></td><td>102</td></tr> <tr><td>53 xx</td><td><b>z145z-x</b></td><td></td><td>447</td></tr> </table> <p>*NB:min. 2 chairs in same colour</p> <p>Upcharge for 2 electrical outlets</p> <p>Upcharge 2xtables+2xel.outlets</p>				53 xx	<b>0145D</b>	Veneered seat	1 357	53 xx	<b>0145A-x</b>	Price group 1	1 443	53 xx	<b>0145A-x</b>	Price group 2	1 473	53 xx	<b>0145A-x</b>	Price group 3	1 505	53 xx	<b>0145A-x</b>	Price group 4	1 538	53 xx	<b>0145A-x</b>	Price group 5	1 576	53 xx	<b>0145A-x</b>	Price group 6	1 627	53 xx	<b>0145A-x</b>	Price group 7	1 699	53 xx	<b>0145A-x</b>	Leather*	1 871	53 xx	<b>z145z-x</b>		102	53 xx	<b>z145z-x</b>		447
53 xx	<b>0145D</b>	Veneered seat	1 357																																													
53 xx	<b>0145A-x</b>	Price group 1	1 443																																													
53 xx	<b>0145A-x</b>	Price group 2	1 473																																													
53 xx	<b>0145A-x</b>	Price group 3	1 505																																													
53 xx	<b>0145A-x</b>	Price group 4	1 538																																													
53 xx	<b>0145A-x</b>	Price group 5	1 576																																													
53 xx	<b>0145A-x</b>	Price group 6	1 627																																													
53 xx	<b>0145A-x</b>	Price group 7	1 699																																													
53 xx	<b>0145A-x</b>	Leather*	1 871																																													
53 xx	<b>z145z-x</b>		102																																													
53 xx	<b>z145z-x</b>		447																																													
	<p><b>Lenght 1850mm</b></p> <p>Oak, ash, stained oak / ash</p> <p>With upholstered seat cushion</p> <table border="1"> <tr><td>53 xx</td><td><b>0185D</b></td><td>Veneered seat</td><td>1 489</td></tr> <tr><td>53 xx</td><td><b>0185A-x</b></td><td>Price group 1</td><td>1 605</td></tr> <tr><td>53 xx</td><td><b>0185A-x</b></td><td>Price group 2</td><td>1 646</td></tr> <tr><td>53 xx</td><td><b>0185A-x</b></td><td>Price group 3</td><td>1 690</td></tr> <tr><td>53 xx</td><td><b>0185A-x</b></td><td>Price group 4</td><td>1 733</td></tr> <tr><td>53 xx</td><td><b>0185A-x</b></td><td>Price group 5</td><td>1 785</td></tr> <tr><td>53 xx</td><td><b>0185A-x</b></td><td>Price group 6</td><td>1 854</td></tr> <tr><td>53 xx</td><td><b>0185A-x</b></td><td>Price group 7</td><td>1 952</td></tr> <tr><td>53 xx</td><td><b>0185A-x</b></td><td>Leather*</td><td>2 003</td></tr> <tr><td>53 xx</td><td><b>z185z-x</b></td><td></td><td>102</td></tr> <tr><td>53 xx</td><td><b>z185z-x</b></td><td></td><td>447</td></tr> </table> <p>*NB:min. 2 chairs in same colour</p> <p>Upcharge for 2 electrical outlets</p> <p>Upcharge 2xtables+2xel.outlets</p>				53 xx	<b>0185D</b>	Veneered seat	1 489	53 xx	<b>0185A-x</b>	Price group 1	1 605	53 xx	<b>0185A-x</b>	Price group 2	1 646	53 xx	<b>0185A-x</b>	Price group 3	1 690	53 xx	<b>0185A-x</b>	Price group 4	1 733	53 xx	<b>0185A-x</b>	Price group 5	1 785	53 xx	<b>0185A-x</b>	Price group 6	1 854	53 xx	<b>0185A-x</b>	Price group 7	1 952	53 xx	<b>0185A-x</b>	Leather*	2 003	53 xx	<b>z185z-x</b>		102	53 xx	<b>z185z-x</b>		447
53 xx	<b>0185D</b>	Veneered seat	1 489																																													
53 xx	<b>0185A-x</b>	Price group 1	1 605																																													
53 xx	<b>0185A-x</b>	Price group 2	1 646																																													
53 xx	<b>0185A-x</b>	Price group 3	1 690																																													
53 xx	<b>0185A-x</b>	Price group 4	1 733																																													
53 xx	<b>0185A-x</b>	Price group 5	1 785																																													
53 xx	<b>0185A-x</b>	Price group 6	1 854																																													
53 xx	<b>0185A-x</b>	Price group 7	1 952																																													
53 xx	<b>0185A-x</b>	Leather*	2 003																																													
53 xx	<b>z185z-x</b>		102																																													
53 xx	<b>z185z-x</b>		447																																													
	<p><b>Length 2250mm</b></p> <p>Oak, ash, stained oak / ash</p> <p>With upholstered seat cushion</p> <table border="1"> <tr><td>53 xx</td><td><b>0225D</b></td><td>Veneered seat</td><td>1 622</td></tr> <tr><td>53 xx</td><td><b>0225A-x</b></td><td>Price group 1</td><td>1 759</td></tr> <tr><td>53 xx</td><td><b>0225A-x</b></td><td>Price group 2</td><td>1 807</td></tr> <tr><td>53 xx</td><td><b>0225A-x</b></td><td>Price group 3</td><td>1 859</td></tr> <tr><td>53 xx</td><td><b>0225A-x</b></td><td>Price group 4</td><td>1 911</td></tr> <tr><td>53 xx</td><td><b>0225A-x</b></td><td>Price group 5</td><td>1 972</td></tr> <tr><td>53 xx</td><td><b>0225A-x</b></td><td>Price group 6</td><td>2 054</td></tr> <tr><td>53 xx</td><td><b>0225A-x</b></td><td>Price group 7</td><td>2 169</td></tr> <tr><td>53 xx</td><td><b>0225A-x</b></td><td>Leather*</td><td>2 136</td></tr> <tr><td>53 xx</td><td><b>z225z-x</b></td><td></td><td>102</td></tr> <tr><td>53 xx</td><td><b>z225z-x</b></td><td></td><td>447</td></tr> </table> <p>*NB:min. 2 chairs in same colour</p> <p>Upcharge for 2 electrical outlets</p> <p>Upcharge 2xtables+2xel.outlets</p>				53 xx	<b>0225D</b>	Veneered seat	1 622	53 xx	<b>0225A-x</b>	Price group 1	1 759	53 xx	<b>0225A-x</b>	Price group 2	1 807	53 xx	<b>0225A-x</b>	Price group 3	1 859	53 xx	<b>0225A-x</b>	Price group 4	1 911	53 xx	<b>0225A-x</b>	Price group 5	1 972	53 xx	<b>0225A-x</b>	Price group 6	2 054	53 xx	<b>0225A-x</b>	Price group 7	2 169	53 xx	<b>0225A-x</b>	Leather*	2 136	53 xx	<b>z225z-x</b>		102	53 xx	<b>z225z-x</b>		447
53 xx	<b>0225D</b>	Veneered seat	1 622																																													
53 xx	<b>0225A-x</b>	Price group 1	1 759																																													
53 xx	<b>0225A-x</b>	Price group 2	1 807																																													
53 xx	<b>0225A-x</b>	Price group 3	1 859																																													
53 xx	<b>0225A-x</b>	Price group 4	1 911																																													
53 xx	<b>0225A-x</b>	Price group 5	1 972																																													
53 xx	<b>0225A-x</b>	Price group 6	2 054																																													
53 xx	<b>0225A-x</b>	Price group 7	2 169																																													
53 xx	<b>0225A-x</b>	Leather*	2 136																																													
53 xx	<b>z225z-x</b>		102																																													
53 xx	<b>z225z-x</b>		447																																													

Illustration	Description	Article number	EUR																																																
<b>Mute Focus Design: Fredrik Mattson</b>																																																			
	<p><b>Mute Focus SEATING FURNITURE</b></p> <ul style="list-style-type: none"> <li>• Frame in lacquered or veneered chipboard.</li> <li>• Stuffing in HR foam. CMHR against upcharge.</li> <li>• Seat height 46 cm</li> <li>• Delivered assembled, only the table top needs to be assembled.</li> <li>• For more produk information see <a href="http://www.horreds.se">www.horreds.se</a></li> </ul> <p><u>White lacquer:</u> NCS 0500-N  <u>Veneer group 1:</u> Oak (03), Ash (06)  <u>Veneer group 2:</u> Black ash (86), Dark ash (76), White oak (30), White ash (10), Burgundy stained ash (C8), Conifer stained ash (D3) and Smokey Blue stained ash (D4).</p>																																																		
	<p><i>Mute Focus Low &amp; Mute Focus, fully upholstered</i></p>			<p><i>Mute Focus Low &amp; Mute Focus, veneered outside</i></p>																																															
	<p>Mute Focus Low, <b>left</b>, fully upholstered, 122x77x79cm.                  Incl. 1xpower + 1xdouble USB-C charger (PM50+52)                  Black metal legs.                  Delivered assembled, only the table needs to be assembled.                  Max.weight for table top: 50 kg.  <i>Upcharge for CMHR</i></p>	<p>55Fxx <b>400V-xxx</b></p>	<table border="1"> <thead> <tr> <th>Fabric group</th> <th>Table white lacquer</th> <th>Table optional NCS</th> <th>Table veneer group 1</th> <th>Table veneer group 2</th> </tr> </thead> <tbody> <tr><td>PG 1</td><td>3 587</td><td>3 587</td><td>3 587</td><td>3 587</td></tr> <tr><td>PG 2</td><td>3 771</td><td>3 771</td><td>3 771</td><td>3 771</td></tr> <tr><td>PG 3</td><td>3 980</td><td>3 980</td><td>3 980</td><td>3 980</td></tr> <tr><td>PG 4</td><td>4 188</td><td>4 188</td><td>4 188</td><td>4 188</td></tr> <tr><td>PG 5</td><td>4 421</td><td>4 421</td><td>4 421</td><td>4 421</td></tr> <tr><td>PG 6</td><td>4 679</td><td>4 679</td><td>4 679</td><td>4 679</td></tr> <tr><td>PG 7</td><td>5 047</td><td>5 047</td><td>5 047</td><td>5 047</td></tr> <tr><td></td><td>72</td><td>72</td><td>72</td><td>72</td></tr> </tbody> </table>	Fabric group	Table white lacquer	Table optional NCS	Table veneer group 1	Table veneer group 2	PG 1	3 587	3 587	3 587	3 587	PG 2	3 771	3 771	3 771	3 771	PG 3	3 980	3 980	3 980	3 980	PG 4	4 188	4 188	4 188	4 188	PG 5	4 421	4 421	4 421	4 421	PG 6	4 679	4 679	4 679	4 679	PG 7	5 047	5 047	5 047	5 047		72	72	72	72			
Fabric group	Table white lacquer	Table optional NCS	Table veneer group 1	Table veneer group 2																																															
PG 1	3 587	3 587	3 587	3 587																																															
PG 2	3 771	3 771	3 771	3 771																																															
PG 3	3 980	3 980	3 980	3 980																																															
PG 4	4 188	4 188	4 188	4 188																																															
PG 5	4 421	4 421	4 421	4 421																																															
PG 6	4 679	4 679	4 679	4 679																																															
PG 7	5 047	5 047	5 047	5 047																																															
	72	72	72	72																																															
	<p>Mute Focus Low, <b>right</b>, fully upholstered, 122x77x79cm.                  Incl. 1xpower + 1xdouble USB-C charger (PM50+52)                  Black metal legs.                  Delivered assembled, only the table needs to be assembled.                  Max.weight for table top: 50 kg.  <i>Upcharge for CMHR</i></p>	<p>55Fxx <b>400H-xxx</b></p>	<table border="1"> <thead> <tr> <th>Fabric group</th> <th>Table white lacquer</th> <th>Table optional NCS</th> <th>Table veneer group 1</th> <th>Table veneer group 2</th> </tr> </thead> <tbody> <tr><td>PG 1</td><td>3 587</td><td>3 587</td><td>3 587</td><td>3 587</td></tr> <tr><td>PG 2</td><td>3 771</td><td>3 771</td><td>3 771</td><td>3 771</td></tr> <tr><td>PG 3</td><td>3 980</td><td>3 980</td><td>3 980</td><td>3 980</td></tr> <tr><td>PG 4</td><td>4 188</td><td>4 188</td><td>4 188</td><td>4 188</td></tr> <tr><td>PG 5</td><td>4 421</td><td>4 421</td><td>4 421</td><td>4 421</td></tr> <tr><td>PG 6</td><td>4 679</td><td>4 679</td><td>4 679</td><td>4 679</td></tr> <tr><td>PG 7</td><td>5 047</td><td>5 047</td><td>5 047</td><td>5 047</td></tr> <tr><td></td><td>72</td><td>72</td><td>72</td><td>72</td></tr> </tbody> </table>	Fabric group	Table white lacquer	Table optional NCS	Table veneer group 1	Table veneer group 2	PG 1	3 587	3 587	3 587	3 587	PG 2	3 771	3 771	3 771	3 771	PG 3	3 980	3 980	3 980	3 980	PG 4	4 188	4 188	4 188	4 188	PG 5	4 421	4 421	4 421	4 421	PG 6	4 679	4 679	4 679	4 679	PG 7	5 047	5 047	5 047	5 047		72	72	72	72			
Fabric group	Table white lacquer	Table optional NCS	Table veneer group 1	Table veneer group 2																																															
PG 1	3 587	3 587	3 587	3 587																																															
PG 2	3 771	3 771	3 771	3 771																																															
PG 3	3 980	3 980	3 980	3 980																																															
PG 4	4 188	4 188	4 188	4 188																																															
PG 5	4 421	4 421	4 421	4 421																																															
PG 6	4 679	4 679	4 679	4 679																																															
PG 7	5 047	5 047	5 047	5 047																																															
	72	72	72	72																																															

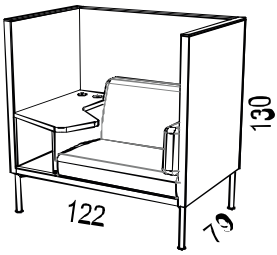
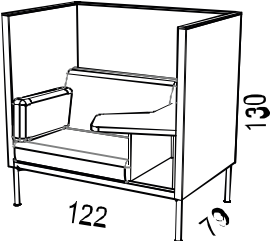
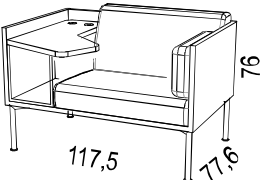
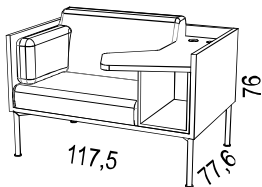
Illustration	Description	Article number	EUR				
			Fabric group	Table white lacquer	Table optional NCS	Table veneer group 1	Table veneer group 2
	<p>Mute Focus <b>left</b>, fully upholstered. 122x130x79cm. Incl. 1xpower + 1xdouble USB-C charger (PM50+52) Delivered assembled, only the table needs to be assembled. Max.weight for table top: 50 kg. <i>Upcharge for CMHR</i></p>	55Fxx <b>300V-xxx</b>	PG 1	4 067	4 067	4 067	4 067
			PG 2	4 353	4 353	4 353	4 353
			PG 3	4 677	4 677	4 677	4 677
			PG 4	5 002	5 002	5 002	5 002
			PG 5	5 365	5 365	5 365	5 365
			PG 6	5 765	5 765	5 765	5 765
			PG 7	6 338	6 338	6 338	6 338
				97	97	97	97
	<p>Mute Focus <b>right</b>, fully upholstered. 122x130x79cm. Incl. 1xpower + 1xdouble USB-C charger (PM50+52) Delivered assembled, only the table needs to be assembled. Max.weight for table top: 50 kg. <i>Upcharge for CMHR</i></p>	55Fxx <b>300H-xxx</b>	PG 1	4 067	4 067	4 067	4 067
			PG 2	4 353	4 353	4 353	4 353
			PG 3	4 677	4 677	4 677	4 677
			PG 4	5 002	5 002	5 002	5 002
			PG 5	5 365	5 365	5 365	5 365
			PG 6	5 765	5 765	5 765	5 765
			PG 7	6 338	6 338	6 338	6 338
				97	97	97	97
	<p>Mute Focus Low, <b>left</b>, 117,5x76x77,6cm. Incl. 1xpower + 1xdouble USB-C charger (PM50+52) Black metal legs. Delivered assembled, only the table needs to be assembled. Max.weight for table top: 50 kg. <i>Upcharge for CMHR</i></p>	55Fxx <b>200V-xxx</b>	Fabric group	White laquer	Optional NCS	Veneer group 1	Veneer group 2
			PG 1	3 826	4 230	4 353	4 353
			PG 2	3 898	4 303	4 426	4 426
			PG 3	3 970	4 375	4 498	4 498
			PG 4	4 043	4 447	4 570	4 570
			PG 5	4 127	4 531	4 654	4 654
			PG 6	4 238	4 642	4 765	4 765
			PG 7	4 405	4 810	4 933	4 933
Läder	4 719	5 123	5 247	5 247			
	48	48	48	48			
	<p>Mute Focus Low, <b>right</b>, 117,5x76x77,6cm. Incl. 1xpower + 1xdouble USB-C charger (PM50+52) Black metal legs. Delivered assembled, only the table needs to be assembled. Max.weight for table top: 50 kg. <i>Upcharge for CMHR</i></p>	55Fxx <b>200H-xxx</b>	PG 1	3 826	4 230	4 353	4 353
			PG 2	3 898	4 303	4 426	4 426
			PG 3	3 970	4 375	4 498	4 498
			PG 4	4 043	4 447	4 570	4 570
			PG 5	4 127	4 531	4 654	4 654
			PG 6	4 238	4 642	4 765	4 765
			PG 7	4 405	4 810	4 933	4 933
			Läder	4 719	5 123	5 247	5 247
	48	48	48	48			



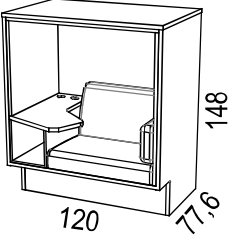
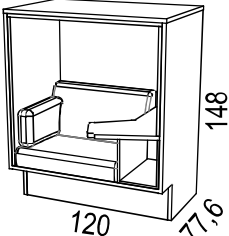
Illustration	Description	Article number	EUR				
			Fabric group	White laquer	Optional NCS	Veneer group 1	Veneer group 2
	<p><b>Mute Focus left</b> 120x148x77,6cm. Incl. 1xpower + 1xdouble USB-C charger (PM50+52) Led lightning. Delivered assembled, only the table needs to be assembled. Max.weight for table top: 50 kg. <i>Upcharge for CMHR</i></p>	55Fxx <b>100V-xxx</b>	PG 1	5 453	5 936	6 588	6 588
			PG 2	5 659	6 142	6 795	6 795
			PG 3	5 866	6 349	7 002	7 002
			PG 4	6 073	6 556	7 209	7 209
			PG 5	6 311	6 794	7 447	7 447
			PG 6	6 629	7 113	7 765	7 765
			PG 7	7 107	7 590	8 242	8 242
			Läder	7 195	7 678	8 330	8 330
				85	85	85	85
				<p><b>Mute Focus right</b> 120x148x77,6cm. Incl. 1xpower + 1xdouble USB-C charger (PM50+52) Led lightning. Delivered assembled, only the table needs to be assembled. Max.weight for table top: 50 kg. <i>Upcharge for CMHR</i></p>	55Fxx <b>100H-xxx</b>	PG 1	5 453
PG 2	5 659	6 142				6 795	6 795
PG 3	5 866	6 349				7 002	7 002
PG 4	6 073	6 556				7 209	7 209
PG 5	6 311	6 794				7 447	7 447
PG 6	6 629	7 113				7 765	7 765
PG 7	7 107	7 590				8 242	8 242
Läder	7 195	7 678				8 330	8 330
	85	85				85	85


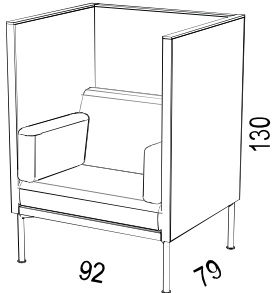
Illustration	Description	Article number	Price group	EUR
<p><b>Mute Focus fåtölj</b> Design:Fredrik Mattson</p>				
	<p><b>Mute Focus Easy chair</b></p> <ul style="list-style-type: none"> <li>• Upholstered easy chair with padding in HR foam</li> <li>• Seat height 46 cm</li> <li>• Delivered assembled</li> <li>• For more produkt information see; <a href="http://www.horreds.se">www.horreds.se</a></li> </ul>			
	<p>Mute Focus easy chair, upholstered 92x130x79cm Seat height 46cm Black metal legs. Delivered assembled.</p>	<p>55F <b>500</b> -xxx</p>	<p>PG 1 PG 2 PG 3 PG 4 PG 5 PG 6 PG 7</p>	<p>2 634 2 904 3 175 3 442 3 754 4 168 4 789</p>

Illustration	Description	Article number	EUR
--------------	-------------	----------------	-----

**Mute Floor Design: Fredrik Mattson**

**Mute Floor SEATING FURNITURE**



- Mute is made of lacquered alternatively veneered particle board
- Padding in HR foam. CMHR against upcharge.
- Sitthöjd 46 cm
- Mute Floorx4 och Mute Floorx2 are delivered unassembled. Mute Floorx1 is delivered assembled. If you wish to have it sent unassembled, please notify customer service.
- For more product information see [www.horreds.se](http://www.horreds.se)

White lacquer: NCS 0500-N

Veneer group 1: Oak (03), Ash (06)

Veneer group 2: Black stained.Ash (86), Dark stained Ash (76), White pigm.Oak (30), White pigmented Ash (10), Black ash (86), Dark ash (76), White oak (30), White ash (10), Burgundy stained ash (C8), Conifer stained ash (D3) and Smokey Blue stained ash (D4).



Mute Floor x4



Mute Floor x2



Mute Floor x1

Illustration	Description	Article number	Fabric group	White laquer	Optional NCS	Veneer group 1	Veneer group 2
			PG 1	14 111	14 953	15 795	15 795
			PG 2	14 474	15 316	16 158	16 158
			PG 3	14 837	15 679	16 521	16 521
			PG 4	15 200	16 042	16 884	16 884
			PG 5	15 563	16 405	17 247	17 247
			PG 6	16 186	17 029	17 871	17 871
			PG 7	17 122	17 964	18 806	18 806
			Leather	18 286	19 128	19 970	19 970
				2 302	2 302	2 749	2 749
				121	121	121	121
	Mute Floor x4, 200x180x136cm. Inkl.2 xpower 2x double USB-C charger (PD50+52) LED lamp ,mat anthracite. Delivered knock-down. Max.weight for table top: 50 kg. <i>Upcharge for wooden back</i> <i>Upcharge for CMHR foam</i> <b>No back wall, entrance from both sides</b>	55 xx <b>06790-xxx</b>	PG 1	14 111	14 953	15 795	15 795
			PG 2	14 474	15 316	16 158	16 158
	Mute Floor x2, 200x180x85cm. Inkl.2 xpower 1x double USB-C charger (PD50+52) LED lamp ,mat anthracite. Delivered knock-down. Max.weight for table top: 50 kg. <i>Upcharge for CMHR foam</i> <b>With back wall, entrance from one side</b>	55 xx <b>06985-xxx</b>	PG 1	8 825	10 298	11 183	11 183
			PG 2	9 188	10 662	11 546	11 546
			PG 3	9 551	11 025	11 909	11 909
			PG 4	9 732	11 206	12 090	12 090
			PG 5	10 095	11 569	12 453	12 453
			PG 6	10 644	12 118	13 002	13 002
			PG 7	11 467	12 941	13 825	13 825
			Leather	12 818	14 292	15 176	15 176
				85	85	85	85

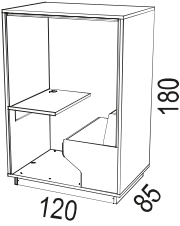
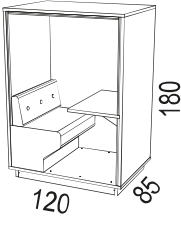
Illustration	Description	Article number	EUR				
			Fabric group	White laquer	Optional NCS	Veneer group 1	Veneer group 2
	<p><b>Mute Floor left</b> 120x180x85cm. Inkl.1 xpower 1x double USB-C charger (PD50+52) LED lamp ,mat anthracite. Delivered assembled Max.weight for table top: 50 kg. <i>Upcharge for CMHR foam</i> <b>With back wall, entrance from one side</b></p>	55 xx <b>311V-xxx</b>	PG 1	6 426	7 689	8 194	8 194
			PG 2	6 607	7 871	8 376	8 376
			PG 3	6 970	8 234	8 739	8 739
			PG 4	7 152	8 415	8 921	8 921
			PG 5	7 515	8 778	9 284	9 284
			PG 6	7 914	9 177	9 682	9 682
			PG 7	8 513	9 776	10 281	10 281
			Leather	8 967	10 230	10 736	10 736
				60	60	60	60
			<p><i>NOTE: Mute Floor x1 (art 311V/H) is delivered assembled!</i> <i>Please notify customer service if it has to be delivered knock-down due to size limit of entrance doors.</i> <i>The width of the pallet is 95 cm.</i></p>				
	<p><b>Mute Floor right</b> 120x180x85cm. Inkl.1 xpower 1x double USB-C charger (PD50+52) LED lamp, mat anthracite Delivered assembled Max.weight for table top: 50 kg. <i>Upcharge for CMHR foam</i> <b>With back wall, entrance from one side</b></p>	55 xx <b>311H-xxx</b>	PG 1	6 426	7 689	8 194	8 194
			PG 2	6 607	7 871	8 376	8 376
			PG 3	6 970	8 234	8 739	8 739
			PG 4	7 152	8 415	8 921	8 921
			PG 5	7 515	8 778	9 284	9 284
			PG 6	7 914	9 177	9 682	9 682
			PG 7	8 513	9 776	10 281	10 281
			Leather	8 967	10 230	10 736	10 736
				60	60	60	60
			<p><i>NOTE: Mute Floor x1 (art 311V/H) is delivered assembled!</i> <i>Please notify customer service if it has to be delivered knock-down due to size limit of entrance doors.</i> <i>The width of the pallet is 95 cm.</i></p>				




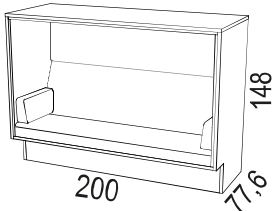
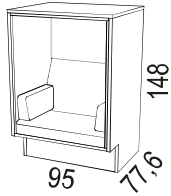
Illustration	Description	Article number	EUR				
<p><b>Mute</b> Design:Fredrik Mattson</p> <p><b>Mute</b> SOFA AND EASY CHAIR </p> <ul style="list-style-type: none"> <li>• Frame in lacquered or veneered chipboard.</li> <li>• Stuffing in HR foam. CMHR against upcharge.</li> <li>• Seat height 46 cm</li> <li>• Delivered assembled.</li> <li>• For more produk information see <a href="http://www.horreds.se">www.horreds.se</a></li> </ul> <p><u>White lacquer:</u> NCS 0500-N  <u>Veneer group 1:</u> Oak (03), Ash (06)  <u>Veneer group 2:</u> Black ash (86), Dark ash (76), White oak (30), White ash (10), Burgundy stained ash (C8), Conifer stained ash (D3) and Smokey Blue stained ash (D4).</p>							
 <p>Mute sofa</p>		 <p>Mute easy chair</p>					
			Fabric group	White laquer	Optional NCS	Veneer group 1	Veneer group 2
 <p>200 148 77,6</p>	<p>Mute sofa with roof 200x148x77,6cm. Delivered assembled. <i>(Notify customer serv. at the time of ordering if you want it to be sent unassembled!)</i></p> <p><i>Upcharge for CMHR</i></p>	<p>55 xx <b>04350-xxx</b></p>	PG 1	6 587	7 293	9 005	9 005
			PG 2	6 860	7 565	9 277	9 277
			PG 3	7 114	7 819	9 532	9 532
			PG 4	7 295	8 001	9 713	9 713
			PG 5	7 604	8 309	10 022	10 022
			PG 6	8 003	8 708	10 421	10 421
			PG 7	8 602	9 307	11 020	11 020
			Leather	12 632	13 337	15 050	15 050
				85	85	85	85
 <p>95 148 77,6</p>	<p>Mute easy chair with roof 95x148x77,6cm. Delivered assembled.</p> <p><i>Upcharge for CMHR</i></p>	<p>55 xx <b>03650-xxx</b></p>	PG 1	4 633	5 338	5 641	5 641
			PG 2	4 815	5 520	5 822	5 822
			PG 3	4 960	5 665	5 967	5 967
			PG 4	5 087	5 792	6 094	6 094
			PG 5	5 268	5 974	6 276	6 276
			PG 6	5 518	6 223	6 525	6 525
			PG 7	5 892	6 597	6 899	6 899
			Leather	7 719	8 424	8 726	8 726
				60	60	60	60


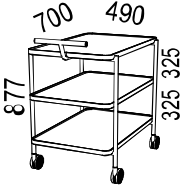
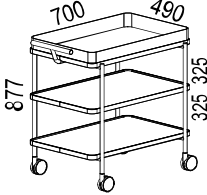
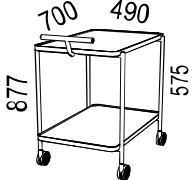
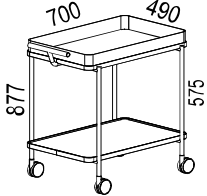



Illustration	Description	Article number	Material	EUR
<b>EXO TROLLEY Design: Mathieu Gustafsson &amp; Daniel Lavonius Jarefeldt, Tengbom</b>				
	<p><b>EXO-TROLLEY Serving Trolley</b></p> <ul style="list-style-type: none"> <li>• Trolley in black texture lacquer RAL9005 with castors. Other colours on request.</li> <li>• Shelves in white (31K) and black (37K) compact laminate alternatively oak and ash veneer; oak nature (03), ash nature (06) black ash (86), dark ash (76), white oak (30), white ash (10), stained ash Burgundy (C8), stained ash Conifer (D3) and stained ash Smokey Blue (D4).</li> <li>• Troughs in black metal and copper,</li> <li>• Serving tray and bottle holder in black metal with inlays matching the shelves.</li> <li>• 4 castors (diameter 75 mm) of which 2 are lockable.</li> <li>• Max weight capacity 50 kilos.</li> <li>• For more product information: see <a href="http://www.horreds.se">www.horreds.se</a></li> </ul>			
	<p>Trolley with 3 shelves in compact laminate alt. veneer <b>New:</b> height 877 mm</p>	84 37xx <b>08383-2</b>	Black	1 574
	<p>Trolley with 1 trough and 2 shelves in compact laminate or veneer. <b>New:</b> height 877 mm <i>Add.cost for extra trough instead of shelf. Price per trough.</i></p>	84 37xx <b>S8383-4</b> 84 37xx <b>K8383-4</b>	Black/trough black Black/trough copper  Black Copper	1 707 4 019  134 2 445
	<p>Trolley with 2 shelves in compact laminate alt. veneer <b>New:</b> height 877 mm</p>	84 37xx <b>08383-1</b>	Black	1 348
	<p>Trolley with 1 trough and 1 shelf in compact laminate or veneer. <b>New:</b> height 877 mm <i>Add.cost for extra trough instead of shelf</i></p>	84 37xx <b>S8383-3</b> 84 37xx <b>K8383-3</b>	Black/trough black Black/trough copper  Black Copper	1 483 3 794  134 2 445
	<p>Serving tray in black metal, with inlay in same material as shelves</p>	84 37xx <b>05424</b>	Black	365
	<p>Bottle holder in black metal, for 3 bottles, with inlay in same material as shelves</p>	84 37xx <b>05423</b>	Black	378
	<p>Bottle holder in black or white metal, for 6 bottles, with inlay in same material as shelves</p>	84 37xx <b>05425</b>	Black	389

Illustration	Article number	Pcs	Price / piece Horreds NCS / black gables	Price / piece optional NCS / black gables	Price / piece veneer / black gables
--------------	----------------	-----	--	---	---

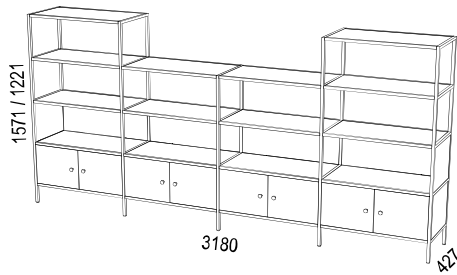
**Parant**

**Parant COMBINATIONS**



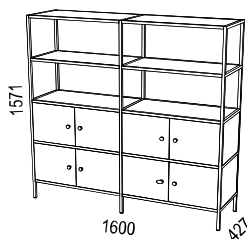
- Parant is a buildable shelf series with black metal gables in several heights. Wooden parts in veneered or lacquered design.
- Gables: RAL9005 structure, with couplings in black plastic.
- Veneer: Oak nature, ash nature, ash white pigmented, ash stained (black, dark, Burgundy, Conifer and Smokey Blue stain),
- Horreds NCS colours: see page 165
- Measurement basic unit: B810xH350XD427mm.
- Measurement sideways add-on module: B790xH350XD427mm.
- Add-on plant pot: height 175mm.
- Distance from floor to lowest shelf: 150mm.
- Contact us for a quote if you want a combination that is not illustrated below.
- For more information; see [www.horreds.se](http://www.horreds.se)

**Combination A.**



Gable 1571x427	34	37	<b>040-A</b>	2	247	247	247
Middle gable 1571x427	34	37	<b>140-B</b>	2	253	253	253
Middle gable 1221x427	34	37	<b>130-A</b>	1	216	216	216
Shelf	34	37xx	<b>09207</b>	14	118	135	152
Back cover	34	37xx	<b>09212</b>	4	94	110	118
Side cover	34	37xx	<b>09331</b>	2	61	75	79
Door module, start	34	37xx	<b>37002</b>	1	537	679	849
Door module, middle	34	37xx	<b>37003</b>	2	537	679	849
Door module, , finish	34	37xx	<b>37004</b>	1	537	679	849
<b>Total price combination A:</b>					<b>5518</b>	<b>6411</b>	<b>7375</b>

**Combination B.**



Gable 1571x427	34	37	<b>040-A</b>	2	247	247	247
Middle gable 1571x427	34	37	<b>140-A</b>	1	253	253	253
Shelf	34	37xx	<b>09207</b>	6	118	135	152
Door module, start	34	37xx	<b>37002</b>	2	537	679	849
Door module, finish	34	37xx	<b>37004</b>	2	537	679	849
<b>Total price combination B:</b>					<b>3605</b>	<b>4271</b>	<b>5058</b>

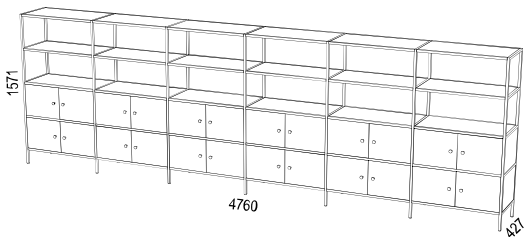
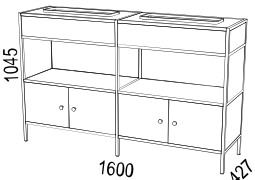
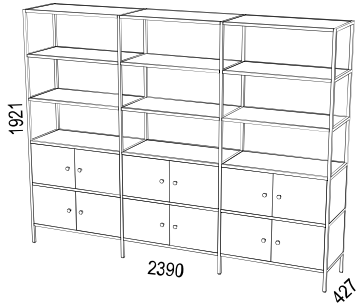
Illustration	Article number	Pcs	Price / piece Horreds NCS / black gables	Price / piece optional NCS / black gables	Price / piece veneer / black gables
<b>Combination C.</b>					
					
Gable 1571x427	34 37 <b>040-A</b>	2	247	247	247
Middle gable 1571x427	34 37 <b>140-A</b>	5	253	253	253
Shelf	34 37xx <b>09207</b>	18	118	135	152
Door module, start	34 37xx <b>37002</b>	2	537	679	849
Door module, middle	34 37xx <b>37003</b>	8	537	679	849
Door module, finish	34 37xx <b>37004</b>	2	537	679	849
<b>Total price comb. C:</b>			<b>11094</b>	<b>12332</b>	<b>14693</b>
<b>Combination D.</b>					
					
Gable 1046x427	34 37 <b>025-A</b>	2	206	206	206
Middle gable 10461x427	34 37 <b>125-A</b>	1	213	213	213
Shelf	34 37xx <b>09207</b>	4	118	135	152
Door module, start	34 37xx <b>37002</b>	1	537	679	849
Door module, finish	34 37xx <b>37004</b>	1	537	537	849
Pot plant add-on	34 37xx <b>09222-2</b>	2	321	356	413
Back cover	34 37xx <b>09212</b>	2	94	110	118
Side cover	34 37xx <b>09331</b>	2	61	75	79
<b>Total price comb. D:</b>			<b>3125</b>	<b>3607</b>	<b>4155</b>
<b>Combination E.</b>					
					
Gable 1921x427	34 37 <b>050-A</b>	2	282	282	282
Middle Gable 1921x427	34 37 <b>150-A</b>	2	288	288	288
Shelf	34 37xx <b>09207</b>	12	118	135	152
Door module, start	34 37xx <b>37002</b>	2	537	679	849
Door module, middle	34 37xx <b>37003</b>	2	537	679	849
Door module, finish	34 37xx <b>37004</b>	2	537	679	849
<b>Total price comb. E:</b>			<b>5783</b>	<b>6833</b>	<b>8066</b>



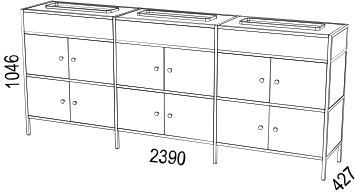
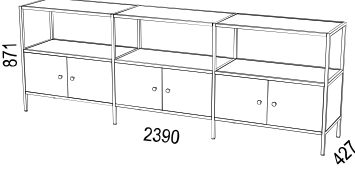
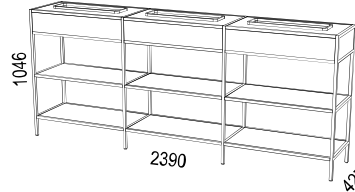
Illustration	Article number	Pcs	Price / piece Horreds NCS / black gables	Price / piece optional NCS / black gables	Price / piece veneer / black gables
<b>Kombination F.</b>					
					
Gable 1046x427	34 37 <b>025-A</b>	2	206	206	206
Middle gable 1046x427	34 37 <b>125-A</b>	2	213	213	213
Shelf	34 37xx <b>09207</b>	3	118	135	152
Door module, start	34 37xx <b>37002</b>	2	537	679	849
Door module, middle	34 37xx <b>37003</b>	2	537	679	849
Door module, finish	34 37xx <b>37004</b>	2	537	679	849
Flower pot add-on	34 37xx <b>09222-2</b>	2	321	356	413
Flower pot add-on, middle	34 37xx <b>09222-3</b>	1	321	356	413
<b>Total price comb. F:</b>			<b><u>5377</u></b>	<b><u>6385</u></b>	<b><u>7627</u></b>
<b>Combination G.</b>					
					
Gable 871x427	34 37 <b>020-A</b>	2	174	174	174
Gable middle 871x427	34 37 <b>120-A</b>	2	181	181	181
Shelf	34 37xx <b>09207</b>	6	118	135	152
Door module, start	34 37xx <b>37002</b>	1	537	679	849
Door module, middle	34 37xx <b>37003</b>	1	537	679	849
Door module, finish	34 37xx <b>37004</b>	1	537	679	849
<b>Total price comb. G:</b>			<b><u>3032</u></b>	<b><u>3558</u></b>	<b><u>4171</u></b>
<b>Combination H.</b>					
					
Gable 1046x427	34 37 <b>025-A</b>	2	206	206	206
Gable middle 1046x427	34 37 <b>125-A</b>	2	213	213	213
Shelf	34 37xx <b>09207</b>	9	118	135	152
Flower pot add-on	34 37xx <b>09222-2</b>	2	321	356	413
Flower pot add-on, middle	34 37xx <b>09222-3</b>	1	321	356	413
<b>Total price comb. H:</b>			<b><u>2868</u></b>	<b><u>3123</u></b>	<b><u>3450</u></b>

Illustration	Article number	Pcs	Price / piece Horreds NCS / black gables	Price / piece optional NCS / black gables	Price / piece vener / black gables
<b>Combination I.</b>					
Gable 871x427	34 37 <b>020-A</b>	1	174	174	174
Gable middle 1221x427	34 37 <b>130-B</b>	1	216	216	216
Gable middle 1571x427	34 37 <b>140-B</b>	1	253	253	253
Gable 1571x427	34 37 <b>040-A</b>	1	247	247	247
Shelf	34 37xx <b>09207</b>	6	118	135	152
Door module, start	34 37xx <b>37002</b>	2	537	679	849
Door module, middle	34 37xx <b>37003</b>	2	537	679	849
Door module, finish	34 37xx <b>37004</b>	2	537	679	849
<b>Total price combination I:</b>			<b>4820</b>	<b>5774</b>	<b>6896</b>



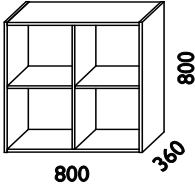
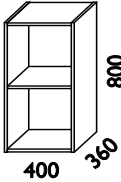
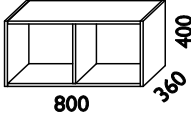
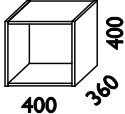
Illustration	Description	Article number	Material	EUR
	<p><b>ANNE Design: Anne Krook.</b></p> <ul style="list-style-type: none"> <li>• White NCS 0500-N.</li> <li>• Veneer: Oak (03), Birch (05) and Ash (06).</li> <li>• Backs in HDF (white to white units and wood pattern to units in birch and oak).</li> <li>• Doors attach only to outer side of units.</li> <li>• Drawers can only be assembled into deep units.</li> <li>• Doors and drawers are assembled before delivery; therefore always enclose a drawing of your Anne combination.</li> <li>• Remote control works through glass doors only (not wooden doors).</li> <li>• Doors with soft-closing hinges.</li> <li>• Drawers with self-closing function.</li> <li>• For more information, see <a href="http://www.horreds.se">www.horreds.se</a></li> </ul>		 <b>MÖBELFAKTA</b>	
<b>Anne DEEP BASIC UNITS</b>				
	<p>Deep basic unit with stationary divider and adjustable shelves.</p> <p>Deep basic unit with stationary divider, without shelves.</p>	<p>16 xx <b>009D</b> 16 31 <b>009D</b></p> <p>16 xx <b>009DU</b> 16 31 <b>009DU</b></p>	<p>Oak/Birch White</p> <p>Oak/Birch White</p>	<p>621 597</p> <p>595 572</p>
	<p>Deep basic unit with adjustable shelf.</p> <p>Deep basic unit without shelf.</p> <p>Deep basic unit with adjustable shelf, without back.</p>	<p>16 xx <b>011D</b> 16 31 <b>011D</b></p> <p>16 xx <b>011DU</b> 16 31 <b>011DU</b></p> <p>16 xx <b>011DO</b> 16 31 <b>011DO</b></p>	<p>Oak/Birch White</p> <p>Oak/Birch White</p> <p>Oak/Birch White</p>	<p>380 365</p> <p>354 340</p> <p>348 334</p>
	<p>Deep basic unit with stationary divider.</p> <p>Deep basic unit without divider.</p> <p>Deep basic unit with stationary divider, without back.</p> <p>Deep basic unit without divider, without back.</p>	<p>16 xx <b>012D</b> 16 31 <b>012D</b></p> <p>16 xx <b>012DU</b> 16 31 <b>012DU</b></p> <p>16 xx <b>012DO</b> 16 31 <b>012DO</b></p> <p>16 xx <b>012DUO</b> 16 xx <b>012DUO</b></p>	<p>Oak/Birch White</p> <p>Oak/Birch White</p> <p>Oak/Birch White</p> <p>Ek/Björk Vit</p>	<p>380 365</p> <p>354 340</p> <p>348 334</p> <p>321 308</p>
	<p>Deep basic unit.</p> <p>Deep basic unit without back</p>	<p>16 xx <b>013D</b> 16 31 <b>013D</b></p> <p>16 xx <b>013DO</b> 16 31 <b>013DO</b></p>	<p>Oak/Birch White</p> <p>Oak/Birch White</p>	<p>251 241</p> <p>223 214</p>

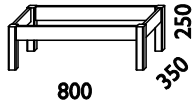
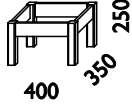
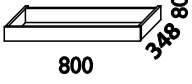
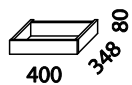
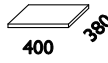
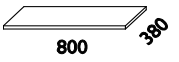
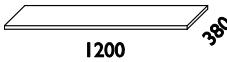
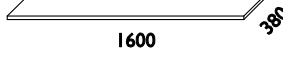
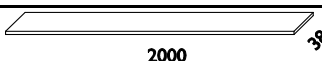
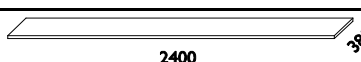
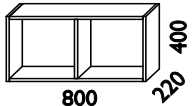
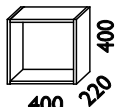
Illustration	Description	Article number	Material	EUR
<b>Anne BASES</b>				
	Deep leg base, wood, 800 mm	16 xx <b>017D</b> 16 31 <b>017D</b>	Oak/Birch White	242 242
	Deep leg base, wood, 400 mm	16 xx <b>018D</b> 16 31 <b>018D</b>	Oak/Birch White	211 211
	Deep base, wood, 800 mm	16 xx <b>007D</b> 16 31 <b>007D</b>	Oak/Birch White	114 114
	Deep base, wood, 400 mm	16 xx <b>008D</b> 16 31 <b>008D</b>	Oak/Birch White	92 92
	800 mm 400 mm	16 00 <b>045</b> 16 00 <b>046</b>		49 39
<b>Anne TOP SHELVES.</b>				
<ul style="list-style-type: none"> <li>• Depth 380 mm. 23 mm thick.</li> <li>• Only suitable to deep basic units (not for shallow units or TV-cabinets).</li> </ul>				
	Length 400 mm	16 xx <b>201</b> 16 31 <b>201</b>	Oak/Birch White	176 176
	Length 800 mm	16 xx <b>202</b> 16 31 <b>202</b>	Oak/Birch White	204 204
	Length 1200 mm	16 xx <b>203</b> 16 31 <b>203</b>	Oak/Birch White	238 238
	Length 1600 mm	16 xx <b>204</b> 16 31 <b>204</b>	Oak/Birch White	299 299
	Length 2000 mm	16 xx <b>206</b> 16 31 <b>206</b>	Oak/Birch White	346 346
	Length 2400 mm	16 xx <b>207</b> 16 31 <b>207</b>	Oak/Birch White	389 389
<b>Anne SHALLOW BASIC UNITS FOR WALL</b>				
	Shallow basic unit with stationary divider.	16 xx <b>012G</b> 16 31 <b>012G</b>	Oak/Birch White	370 355
	Shallow basic unit without divider.	16 xx <b>012GU</b> 16 31 <b>012GU</b>	Oak/Birch White	343 330
	Wallhanging kit in MDF. 800 mm.	16 00 <b>045</b>		49
	Shallow basic unit.	16 xx <b>013G</b> 16 31 <b>013G</b>	Oak/Birch White	232 223
	Wallhanging kit in MDF. 400 mm.	16 00 <b>046</b>		39

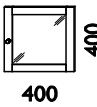
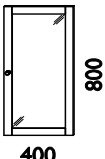
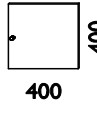
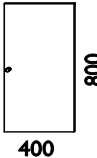
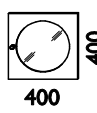
Illustration	Description	Article number	Material	EUR
<b>Anne DOORS</b>		<b>Närmaste NCS:</b>		
		White NCS 0500-N		
		Grey green NCS S2502G		
		Yellow NCS S1050-Y10R		
	Glass door Anne	16 xx <b>031</b>	Oak/Birch	188
	Glass door Anne, with frosted glass	16 31 <b>031</b>	White	188
		16 xx <b>031A</b>	Oak/Birch	211
		16 31 <b>031A</b>	White	211
	Glass door Anne	16 xx <b>032</b>	Oak/Birch	246
	Glass door Anne, with frosted glass	16 31 <b>032</b>	White	246
		16 xx <b>032A</b>	Oak/Birch	269
		16 31 <b>032A</b>	White	269
	Door Anne	16 xx <b>021</b>	Oak/Birch	107
		16 31 <b>021</b>	White	107
		16 48 <b>021</b>	Grey-green	107
		16 49 <b>021</b>	Yellow	107
	Door Anne	16 xx <b>022</b>	Oak/Birch	193
		16 31 <b>022</b>	White	193
		16 48 <b>022</b>	Grey-green	193
		16 49 <b>022</b>	Yellow	193
	Glass door Anne, with round glass	16 xx <b>034</b>	Oak/Birch	143
		16 31 <b>034</b>	White	143
		16 48 <b>034</b>	Grey-green	143
		16 49 <b>034</b>	Yellow	143
	Glass door Anne, with round frosted glass	16 xx <b>034A</b>	Oak/Birch	166
		16 31 <b>034A</b>	White	166
		16 48 <b>034A</b>	Grey-green	166
		16 49 <b>034A</b>	Yellow	166

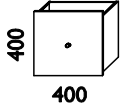
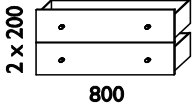
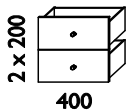


Illustration	Description	Article number	Material	EUR
<b>Anne DRAWERS</b>				
<ul style="list-style-type: none"> <li>• With soft- and self-closing funktion.</li> <li>• Incl standard handle in brushed steel</li> <li>• Fits only in deep basic units</li> </ul>				
	Drawer Anne	16 xx <b>039</b> 16 31 <b>039</b> 16 48 <b>039</b> 16 49 <b>039</b>	Oak/Birch White Grey-green Yellow	229 229 229 229
	Pair of drawers Anne. Only for basic unit 12DU.	16 xx <b>040</b> 16 31 <b>040</b> 16 48 <b>040</b> 16 49 <b>040</b>	Oak/Birch White Grey-green Yellow	515 515 515 515
	Pair of drawers Anne.	16 xx <b>041</b> 16 31 <b>041</b> 16 48 <b>041</b> 16 49 <b>041</b>	Oak/Birch White Grey-green Yellow	363 363 363 363
<b>Anne ACCESSORIES</b>				
	Wine rack for 9D	16 31 <b>042A</b> 16 48 <b>042A</b> 16 49 <b>042A</b>	White Grey-green Yellow	143 143 143
	Wine rack for 11D + 12D	16 31 <b>042B</b> 16 48 <b>042B</b> 16 49 <b>042B</b>	White Grey-green Yellow	143 143 143
	Wine rack for 13D	16 31 <b>042C</b> 16 48 <b>042C</b> 16 49 <b>042C</b>	White Grey-green Yellow	143 143 143
	Deep extra shelf for 9D/9DU+12D. Width 37,5 cm.	16 xx <b>044</b> 16 31 <b>044</b>	Oak/Birch White	57 57
	Deep extra shelf for 11D/11DU+13D With 36,7 cm.	16 xx <b>044B</b> 16 31 <b>044B</b>	Oak/Birch White	57 57
	Shallow extra shelf for 12G Width 37,5 cm.	16 xx <b>047</b> 16 31 <b>047</b>	Oak/Birch White	50 50
	Shallow extra shelf for 13G With 36,7 cm.	16 xx <b>047B</b> 16 31 <b>047B</b>	Oak/Birch White	50 50
	Deep extra shelf for 12DU Width 76,8 cm.	16 xx <b>050</b> 16 31 <b>050</b>	Oak/Birch White	128 128
	Deep glass shelf for 9D/9DU + 12D	16 00 <b>048</b>	Glass	43
	Deep glass shelf for 11D/11DU + 13D	16 00 <b>048B</b>	Glass	43
	Shallow glass shelf for 9G/9GU + 12G	16 00 <b>049</b>	Glass	38
	Shallow glass shelf for 11G/11GU + 13G	16 00 <b>049B</b>	Glass	38
	Mounted lock in door	16 00 <b>058</b>	Förnicklåt	142

Illustration	Description	Article number	Material	EUR
--------------	-------------	----------------	----------	-----

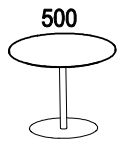
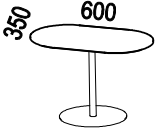
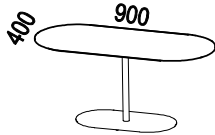


**LAP Design: Fredrik Mattson**

- Table top in 14 mm white compact laminate with black core and chamfered edge alternatively 19 mm veneered MDF 19.
- Column leg in white powder coated steel (RAL 9016)
- Available in 3 heights. Illustrations below show table in height 430 mm
- To round top and to oval top in size 600x350 the column base is round
- To oval top in size 900x400 the column base is oval

Veneer group 1: Oak (03), Ash (06), Birch (05), Beech (04)  
Veneer group 2: Black stained Ash (86), Dark stained Ash (76), White pigmented Oak (30), White pigmented Ash (10) Burgundy stained ash (C8), Conifer stained ash (D3), Smokey Blue stained ash (D4).

Heights: 430 mm (1), 530 mm (2), 630 mm (3)

 <p>500</p>	<p>Round table top, diameter 500 mm, including column leg with round base Height; 430, 530 or 630 mm.</p>	<p>55 xx xx <b>03802-x</b> 55 xx xx <b>03802-x</b> 55 31 xx <b>03802-x</b></p>	<p>Veneer gr 1 Veneer gr 2 White comp.lam.</p>	<p>458 458 519</p>
 <p>350 600</p>	<p>Oval table top, 600x350 mm, including column leg with round base Height; 430, 530 or 630 mm.</p>	<p>55 xx xx <b>03803-x</b> 55 xx xx <b>03803-x</b> 55 31 xx <b>03803-x</b></p>	<p>Veneer gr 1 Veneer gr 2 White comp.lam.</p>	<p>476 476 543</p>
 <p>400 900</p>	<p>Oval table top, 900x400 mm, including column leg with oval base Height; 430, 530 or 630 mm.</p>	<p>55 xx xx <b>03804-x</b> 55 xx xx <b>03804-x</b> 55 31 xx <b>03804-x</b></p>	<p>Veneer gr 1 Veneer gr 2 White comp.lam.</p>	<p>507 507 579</p>

## SALES TERMS

All previous price lists are no longer valid. All prices are quoted in Euro excl. VAT. Our digital price list is regularly updated and products may be added or discontinued. Price adjustments may occur. For the latest issue, see [www.horreds.se](http://www.horreds.se)

## TERMS OF PAYMENT

30 days net or according to agreement.

When payment falls due, we reserve the right charge 2% interest/month. Payment by cheque is not accepted. Only International bank transfers are accepted. Bank details according to the invoice.

## TERMS OF DELIVERY

Deliveries will only be effected at our terms of payment and delivery. The goods remain the property of Horreds Möbel AB until full payment has been settled. Dispatch date is when goods are leaving factory. Standard package is included, pallets and wooden crates are charged separately. Tail gates, fixed delivery date and telephone notification will be charged separately. Quotations submitted by Horreds are, unless otherwise stated, valid for 30 days from the quotation date. For deliveries well ahead of time, e.g. 6 months from the quotation date, this must be agreed on each individual occasion.

## FREIGHT CHARGES

### Europe 1

Finland, Latvia, Lithuania, Estonia, Germany, Benelux.

Free delivery DAP on order above 2500 Euro net. For orders less than 2500 Euro, a freight cost of 225 Euro is charged.

### Europe 2

Austria, United Kingdom, Poland, Czech Republic, Slovakia, Hungary.

Free delivery DAP on order above 2500 Euro net. For orders less than 2500 Euro, a freight cost of 350 Euro is charged.

### Other countries

Ex Works or according to agreement. (documents sent by courier will be charged)

## CLAIMS AND TRANSPORT DAMAGES

Any claims or transport damages must be reported to Horreds. A special claim report shall be sent in together with photos to [export@horreds.se](mailto:export@horreds.se). Visible damages must also be notified on the waybill when receiving the goods. Invisible damages must be reported within 6 days. Photos must be taken on all damages for us to be able to handle the claim.

## GUARANTEE

Office furniture according to Price list 1: 10 years for wood and metal parts with the exception of electric legs having 5 years and clothing material for table screens and insert materials which have 1 year.

Meeting places/Environmental furniture according to Price list 2: 5 years with the exception of clothing material and input material which have 1 year.

Input material such as locks, hinges, electrical parts, expanders and lamps: 1 year.

Customized products: 1 year.


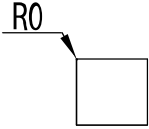
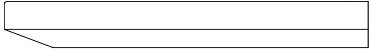
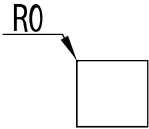

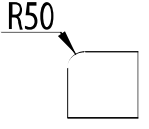

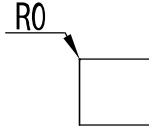
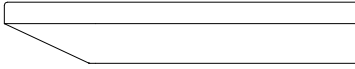
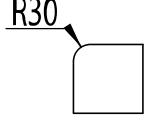

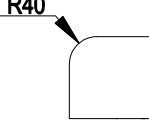

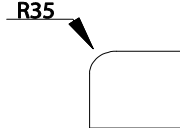

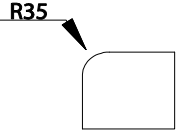
The guarantees are valid from the date of the original invoice against production errors at normal use of the product. We reserve the right to make changes in construction and design without notice.

## FORCE MAJEURE

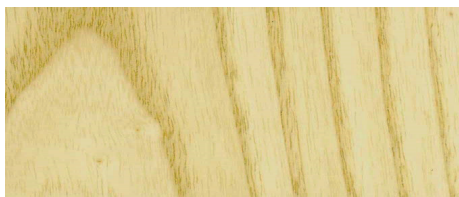
Horreds shall not be liable for any loss, damage, delay, changes in shipment schedules or failure to deliver caused by accidents, fire, strikes, riots, civil commotion, insurrection, war, the elements, embargoes, failure of carriers, inability to obtain transportation facilities, government requirements, acts of God or public enemy, prior orders from customers or limitations on the company's or its supplier's production or marketing activities or any other causes or contingencies beyond the company's control.

SHOWROOMS: Horreds Möbel AB (Head Office), Varbergsvägen 448, HORRED. Tel +46 320 184 00  
R40, Rosenlundsgatan 40, STOCKHOLM. Tel +46 73 828 00 15  
Studio L6, Lasarettsgatan 6, GÖTEBORG. Tel +46 70 241 99 69  
Horreds Möbel AB, Slussgatan 10, 211 30 MALMÖ. Tel +46 70 241 99 69  
Skoyen Design Center, Drammensveien 130C1, OSLO. Tel +47 90 02 89 98  
Norliitt Design, Store Kognensgade 81, COPENHAGEN. Tel +45 23 62 42 42



	<u>Profil / profile:</u>	<u>Radie / radius:</u>
<p><b><u>VX (3416)</u></b>  Rak matchande kantlist i plast alternativt faner. Hörradie 0.  <i>Straight edge, matching edging. Corner radius 0.</i></p>		<p>R0</p> 
<p><b><u>VX (3417)</u></b>  Fasad kant med rak matchande kantlist i plast alternativt faner. Hörradie 0.  <i>Chamfered edge with straight matching edging.</i>  Corner radius 0.</p>		<p>R0</p> 
<p><b><u>VX R50 (3418)</u></b>  Rak matchande kantlist i plast alternativt faner. Hörradie 50.  <i>Straight edge, matching edging. Corner radius 50.</i></p>		<p>R50</p> 
<p><b><u>A-Frame (6416) / Nomono (53) / Tin (47)</u></b>  Rak, matchande kantlist i plast alternativt faner. Hörradie 0.  <i>Straight edge, matching edging. Corner radius 0.</i></p>		<p>R0</p> 
<p><b><u>Fri (3517)</u></b>  Fasad MDF-kant. Klarlackad kant till ask, björk, ek, laminat och desktop. Matchande till betsade och vitpigmenterade bord.  Hörradie 30.  <i>Chamfered MDF edge. Clear coated edge on ash, birch, oak, laminate and linoleum. Matching colour to stained and white pigmented tables.</i>  Corner radius 30.</p>		<p>R30</p> 
<p><b><u>Henry (80)</u></b>  Rak, vit plastkantlist. Hörradie 40.  <i>Straight edge, white edging. Corner radius 40.</i></p>		<p>R40</p> 
<p><b><u>Siglo (6016)</u></b>  Matchande kantlist i plast till laminat och desktop.  Vit kantlist i plast till fanerade bord. Hörradie 35.  <i>Matching edging to laminate and linoleum. White edging to veneered desks. Corner radius 35.</i></p>		<p>R35</p> 
<p><b><u>Siglo (6020)</u></b>  Falsad kant med matchande kantlist i plast till laminat och desktop.  Vit kantlist i plast till fanerade bord. Hörradie 35.  <i>Chamfered with matching edging to laminate and linoleum.</i>  White edging to veneered desks. Corner radius 35.</p>		<p>R35</p> 

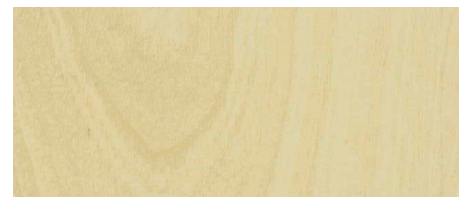
# FANER / VENEER



06 Ask / Ash



03 Ek / Oak



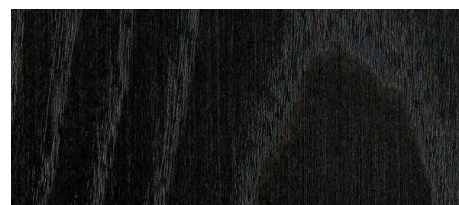
05 Björk / Birch



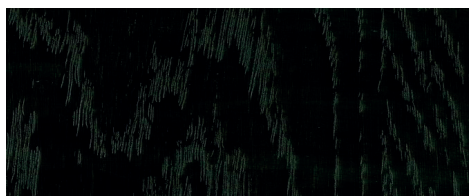
10 Vit ask / White ash



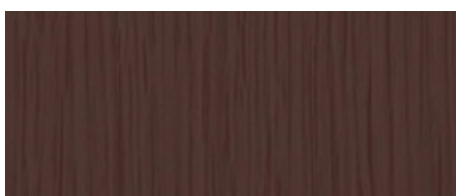
30 Vit ek / White oak



76 Mörk ask / Dark ash



86 Svart ask / Black ash



C8 Burgundy



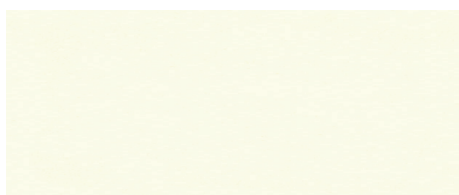
D3 Conifer



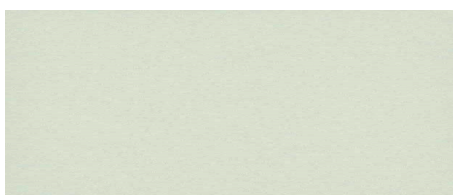
D4 Smokey Blue

Tänk på: I trä som är en naturprodukt kan mindre avvikelser i bets och struktur förekomma /  
Note: In wood, that is a natural product, minor deviations in stain and structure can occur

## LAMINAT (endast bordsskivor) / LAMINATE (table tops only)



Vit 0754 (standardlaminat)  
närmaste NCS S0502-Y



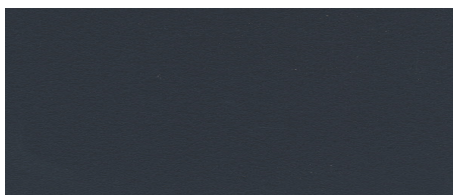
Ljusgrå 0419 (tillvalslaminat)  
närmaste NCS S1500-N



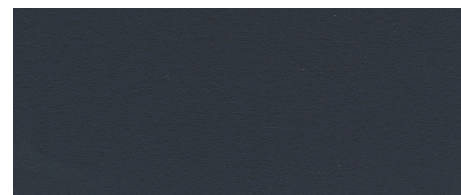
Ljusgrå 1365 (tillvalslaminat)  
närmaste NCS S2005-R80B



Mellanrå 1023 (tillvalslaminat)  
närmaste NCS S5500-N



Antracit 1397 (tillvalslaminat)  
närmaste NCS S7500-N



Svart 2253 (tillvalslaminat)  
närmaste NCS S9000-N

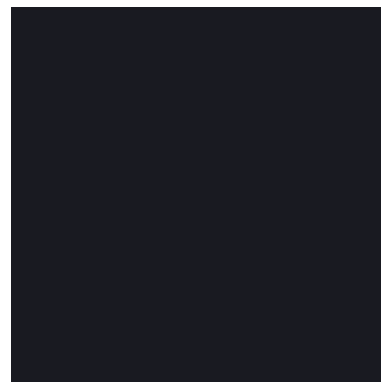
## DESKTOP (endast bordsskivor) / LINOLEUM (table tops only)



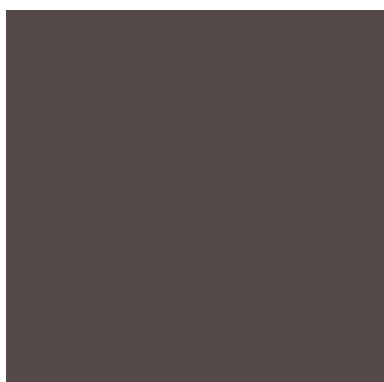
4132 Ash  
closest NCS 5502-G



4154 Burgundy  
closest NCS 7010-R10B



4166 Charcoal  
closest NCS 8502-B



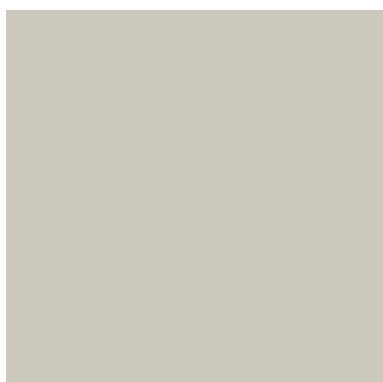
4172 Mauve  
closest NCS 7005-Y80R



4174 Conifer  
closest NCS 8010-B90G



4175 Pebble  
closest NCS 3502-Y



4176 Mushroom  
closest NCS 2002-Y



4177 Vapour  
closest NCS 2005-G10Y



4179 Smokey Blue  
closest NCS 7010-R90B



4184 Olive  
closest NCS 5010-G50Y

Färgavvikelser kan förekomma av trycktekniska skäl

## RAL-KULÖRER METALL / RAL COLOURS METAL



1019 Grey beige (3H)

Tillval utvalda produkter

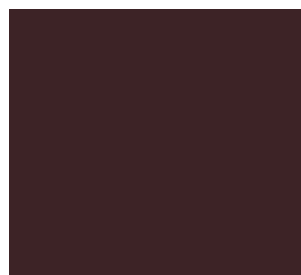
Optional selected products



1024 Ochre yellow (3G)

Tillval utvalda produkter

Optional selected products



3007 Black red (3D)

Tillval utvalda produkter

Optional selected products



5008 Grey blue (3C)

Tillval utvalda produkter

Optional selected products



6009 Fir green (3L)

Tillval utvalda produkter

Optional selected products



6013 Reed green (3K)

Tillval utvalda produkter

Optional selected products



7039 Quartz grey (3J)

Tillval utvalda produkter

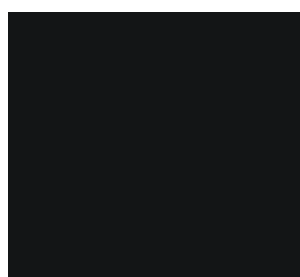
Optional selected products



7044 Silk grey (3A)

Tillval utvalda produkter

Optional selected products



9005 Jet black (37)

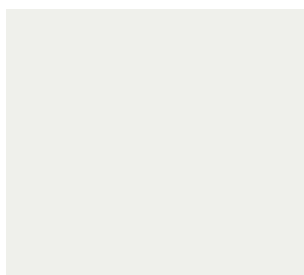
Standard



9006 White alu. (38)

Standard utvalda produkter

Standard selected products



9016 Traffic white (31)

Standard/tillval utvalda produkter

Standard/optional selected prod.

Slät lack med glans 30. Vissa produkter finns endast i standardkulör med strukturlack.

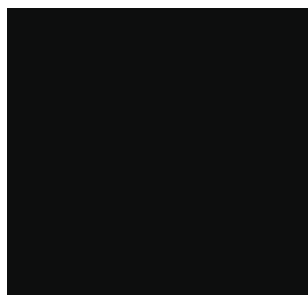
Smooth varnish, gloss 30. Some products are only available in standard colour with textured paint.

Färgavvikelser kan förekomma av trycktekniska skäl  
Colour deviations may occur for printing technical reasons.

## TILLVALSKULÖRER NCS / SELECTED COLOURS NCS



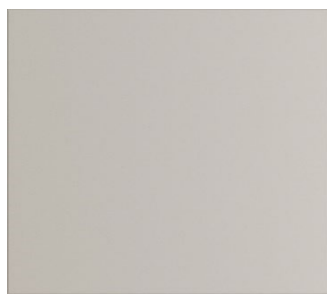
BE Beige  
S3005-Y20R



BK Black  
S 9000-N



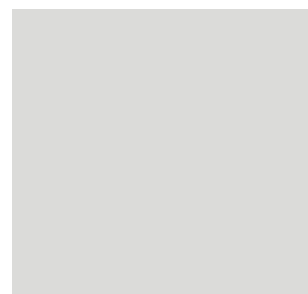
BY Burgundy  
S 7010-R10B



GG Greige  
2903-Y30R



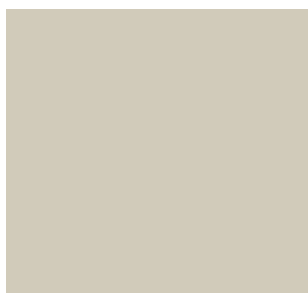
GP Graphite  
S 7500-N



GW Greywhite  
S 1500-N



LG Lightgrey  
S 3000-N



LI Linen  
S 2005-Y20R



OL Olive  
S 5010-G70Y



SB Soft beige  
S 2010-Y30R



SD Sand  
S 4005-Y50R



SG Steel grey  
S 4500-N



WW Warm white  
1204-Y26R

Färgavvikelse kan förekomma av trycktekniska skäl  
Colour deviations may occur for printing technical reasons.

## NOMONO HANDTAG



Svart, black  
närmaste NCS S9000-N



Gul, yellow  
närmaste NCS S1070-Y



Grön, green  
närmaste NCS S2570-G30Y



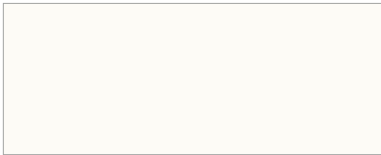
Röd, red  
närmaste NCS S1580-Y80R



Turkosblå, turquoise  
närmaste NCS S0540-B30G



Orange, orange  
närmaste NCS S1080-Y50R



Vit, white  
närmaste NCS S0300-N

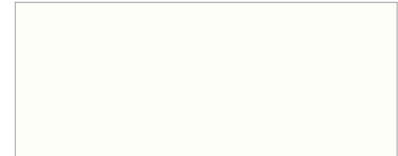
## ANNE-HYLLAN



Björkfaner, birch veneer



Ekfaner, oak veneer



Vit, white  
närmaste NCS S0500-N



Grågrön, grey-green  
närmaste NCS S2502-G



Gul, yellow  
närmaste NCS S1050-Y10R

## Price groups fabrics

Below you will find a list of standard fabrics for our seating furniture.

The list shows the difference price groups and which products it is suitable for.

For price information for fabrics not listed below; please send us a price inquiry.

Several of our products can be produced with multiple fabrics; please send us a price inquirey.

Producer:	Fabric:	Price group:	Base / Cuba	Glove	VX barpall	Mute / LOG / Nomono Bench	Grand / Prime
Camira	Main Line Flax	PG1	•	•	•	•	•
Camira	Main Line Twist	PG1	•	•	•	•	•
Gabriel	Cura	PG1	•	•	•	•	•
Gabriel	Focus	PG1	•	•	•	•	•
Gabriel	Focus Melange	PG1	•	•	•	•	•
Gabriel	Go Uni	PG1	•	•	•	•	•
Gabriel	Medley	PG1	•	•	•	•	•
Gabriel	Step	PG1	•	•	•	•	•
Kvadrat	Autumn	PG1	•	•	•	•	•
Kvadrat	Guest	PG1	•	•	•	•	•
Kvadrat	Reflect	PG1	•	•	•	•	•
Kvadrat	Relate	PG1	•	•	•	•	•
Vescom	Colour Connect	PG1	•	•	•	•	•
Camira	Blazer	PG2	•	•	•	•	•
Camira	Monochrome sett	PG2	•	•	•	•	•
Gabriel	Go Check	PG2	•	•	•	•	•
Gabriel	Parcel Loop	PG2	•	•	•	•	•
Gabriel	Step Melange	PG2	•	•	•	•	•
Gabriel	Tempt	PG2	•	•	•	•	•
Kvadrat	Remix	PG2	•	•	•	•	•
Nevotex	Grace	PG2	•	•	•	•	•
Nevotex	Lido	PG2	•	•	•	•	•
Nevotex	Lido Trend	PG2	•	•	•	•	•
Nevotex	Pod	PG2	•	•	•	•	•
Nevotex	Sealife	PG2	•	•	•	•	•
Nevotex	Stella	PG2	•	•	•	•	•
Svensson	Ally	PG2	•	•	•	•	•
Svensson	Easy	PG2	•	•	•	•	•
Vescom	Avon	PG2	•	•	•	•	•
Vescom	Arches	PG2	•	•	•	•	•
Vescom	Arrow	PG2	•	•	•	•	•
Vescom	Creek	PG2	•	•	•	•	•
Vescom	Cyprus	PG2	•	•	•	•	•
Vescom	Dalma	PG2	•	•	•	•	•
Vescom	Furka Plus	PG2	•	•	•	•	•
Vescom	Jemo	PG2	•	•	•	•	•
Vescom	Leone Plus	PG2	•	•	•	•	•
Vescom	Malta	PG2	•	•	•	•	•

Producer:	Fabric:	Price group:	Base / Cuba	Glove	VX barpall	Mute / LOG / Nomono Bench	Grand / Prime
Vescom	Samar	PG2	•	•	•	•	•
Vescom	Scott	PG2	•	•		•	•
Vescom	Zenith	PG2	•	•	•	•	•
Camira	Synergy	PG3	•	•	•	•	•
Camira	Yoredale	PG3	•	•	•	•	•
Gabriel	Amaze Loop	PG3	•	•	•	•	•
Gabriel	Breeze Fusion	PG3	•	•	•	•	•
Gabriel	Capture	PG3	•	•	•	•	•
Gabriel	Crisp	PG3	•	•	•	•	•
Gabriel	Fame	PG3	•	•	•	•	•
Gabriel	Grain	PG3	•	•	•	•	•
Gabriel	Morph	PG3	•	•	•	•	•
Gabriel	Renewed Loop	PG3	•	•	•	•	•
Gabriel	Select	PG3	•	•	•	•	•
Kvadrat	Ame	PG3	•	•	•	•	•
Kvadrat	Atlas	PG3	•	•	•	•	•
Kvadrat	Sport	PG3	•	•	•	•	•
Nevotex	Imola Plus	PG3	•	•	•	•	•
Nevotex	Jazz	PG3	•	•	•	•	•
Nevotex	Wooly	PG3	•	•	•	•	•
Svensson	Harper	PG3	•	•	•	•	•
Svensson	Heritage Blend	PG3	•	•	•	•	•
Svensson	Semi	PG3	•	•	•	•	•
Svensson	Step	PG3	•	•	•	•	•
Vescom	Acton	PG3	•	•	•	•	•
Vescom	Moore	PG3	•	•	•	•	•
Vescom	Norfolk	PG3	•	•	•	•	•
Vescom	Wilson	PG3	•	•	•	•	•
Bogesunds	Liv	PG4	•	•	•	•	•
Gabriel	Focus Royal	PG4	•	•	•	•	•
Gabriel	Passion	PG4	•	•	•	•	•
Jørgenssen	Puxx 1/2	PG4	•	•		•	•
Kvadrat	Canvas	PG4	•	•	•	•	•
Kvadrat	Re-wool	PG4	•	•	•	•	•
Kvadrat	Steelcut	PG4	•	•	•	•	•
Kvadrat	Steelcut Trio	PG4	•	•	•	•	•
Nevotex	Blues	PG4	•	•	•	•	•
Nevotex	Funk	PG4	•	•	•	•	•
Nevotex	Pop	PG4	•	•	•	•	•
Romo	8028 Elio FR	PG4	•	•	•	•	•
Svensson	Ink	PG4	•	•	•	•	•
Svensson	Mingel	PG4	•	•	•	•	•
Vescom	Auckland	PG4	•	•	•	•	•
Vescom	Dikson	PG4	•	•	•	•	•
Vescom	Foster	PG4	•	•	•	•	•
Vescom	Fuga	PG4	•	•	•	•	•



Producer:	Fabric:	Price group:	Base / Cuba	Glove	VX barpall	Mute / LOG / Nomono Bench	Grand / Prime
Vescom	Hestan	PG4	•	•	•	•	•
Villa Nova	V3571 Linea	PG4	•	•	•	•	•
Gabriel	Savoy	PG5	•	•		•	•
Kirkby Design	K5186 Fibre	PG5	•	•	•	•	•
Kirkby Design	K5260 Fleck ECO	PG5	•	•	•	•	•
Kvadrat	Devina / Devina MD	PG5	•	•	•	•	•
Kvadrat	Devina Melange	PG5	•	•	•	•	•
Kvadrat	Fiord	PG5	•	•	•	•	•
Kvadrat	Hallingdal	PG5	•	•	•	•	•
Kvadrat	Hero	PG5	•	•	•	•	•
Kvadrat	Melange NAP	PG5	•	•	•	•	•
Kvadrat	Steelcut Quartet	PG5	•	•	•	•	•
Maharam	Merit	PG5	•	•	•	•	•
Maharam	Messenger	PG5	•	•	•	•	•
Nevotex	Grand Lazio Velvet	PG5	•	•	•	•	•
Nevotex	Illusion	PG5	•	•		•	•
Nevotex	Illusion Full grain	PG5	•	•		•	•
Svensson	Balance	PG5	•	•	•	•	•
Svensson	Rami	PG5	•	•	•	•	•
Vescom	Lamu	PG5	•	•	•	•	•
Vescom	Lani	PG5	•	•	•	•	•
Vescom	Wolin	PG5	•	•	•	•	•
Gabriel	Nobel	PG6	•	•	•	•	•
Kvadrat	Arda	PG6	•	•	•	•	•
Kvadrat	Mizmaze	PG6	•	•	•	•	•
Nevotex	Barnum	PG6	•	•	•	•	•
Kvadrat	Drop	PG7	•	•	•	•	•
Kvadrat	Sisu	PG7	•	•	•	•	•
Elmo Leather	Elmonordic	Läder	•	•	•	•	•
Elmo Leather	Elmosoft	Läder	•	•	•	•	•
Nevotex	Vintage	Läder	•	•	•	•	•

Rev.2025-02-26

**BE THE  
REBEL  
WITH A  
PURPOSE.**



Horreds Möbel AB  
Varbergsvägen 448, SE-519 30 Horred, SWEDEN  
vx. +46 320 184 00, info@horreds.se

[www.horreds.se](http://www.horreds.se)