

PRICE LIST 2025-01-01
EUR excl. VAT

HORR[®] EDS 1936



HORREDS PRICE LIST EUR EXCL.VAT 2025-01-01

PRICE LIST 1: Office Furniture	
Fast delivery products	3-4
<u>A-FRAME</u>	
Desks	5-7
Screens and accessories	8
<u>NOMONO COMPACT</u>	
Nomono Compact	9-10
<u>NOMONO</u>	
Example arrangements	11-16
Nomono with gables	17-25
Nomono with T-legs	26-28
<u>SIGLO</u>	
Desks	29-32
Screens	33
<u>OTHER DESKS:</u>	
VX/Henry/Fri	34-38
Cable entrie Cable	39-40
VX8 / VX11 bordsstativ	41-42
<u>SCREENS</u>	
VX desk screen	45-46
A-Frame desk screen	8
<u>OFFICE STORAGE:</u>	
Storage with sliding doors, depth 43cm.	
Basic units	47-49
Extension units / trays	50
Bases	51-52
Sliding doors Biblio	53-55
Sliding doors Nomono	56-58
Sliding doors VX	59-61
Siglo	62-65
Storage with hinged doors, depth 43cm	66-67
Accessories storage	68
Personal storage	
VX personal storage	69-74
Side storage	
Biblio	75-76
Nomono A-side	77-78
Siglo	79-81
VX	82-83
Accessories	84

PRICE LIST 2: Meeting / Seating	
<u>MEETING TABLES:</u>	
VX Conference / VX Project / A-Frame	85-99
Nomono conference	100
Tin	101-102
Cable entries and accessories	103-106
<u>SEATING FURNITURE / VARIOUS:</u>	
Prime chair	107
Grand chair	108-111
Grand Balk	112-113
Glove chair	114-117
Glove Bolster Cover	118
Glove Lounge	119
Glove Bar stool	120
Cuba chair	121-122
Cuba chair with quilted upholstery	123-124
Base chair	125-128
VX Bar stool	129
VX Bar stool with castors	130
Log Armchair and Module sofa	131-134
Nomono Bench	135
Mute Focus	136-138
Mute Focus easy chair	139
Mute Floor	140-141
Mute sofa and easy chair	142
Exo Trolley	143
<u>SHELF SYSTEMS:</u>	
Parant	144-147
Anne	148-151
<u>COFFEE TABLES:</u>	
Lap	152
Log Laptop table	132

<u>INFORMATION:</u>	
Sales terms	153
Desk profiles	154
Material and colours	155-159
Price groups fabrics	160-162

Our digital price list is updated continuously.

Products may be added or expire and
price adjustments may occur.

For the latest edition, see www.horreds.se



Fast delivery products

COMPLETE WORK PLACE IN 10 DAYS

Good logistics solutions are the savior of some projects



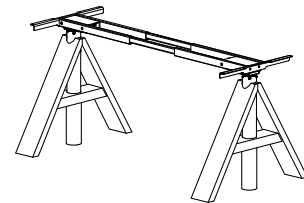
The products will be shipped from us within 10 business days.

We choose not to put any max volumes on this range but must reserve us for out-of-stock.

A-Frame desk tops are available in white HPL (19 mm MDF) and black linoleum (19 mm MDF) without cable lid.

A-Frame electric stand:

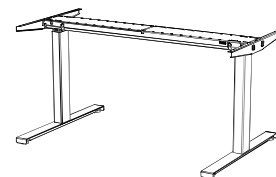
- Range 50 cm (table height 70-120 cm)
- Wooden A-legs in oak or ash with electric legs in white (RAL9016) or black (RAL9005)
- Flexible frame (black RAL9005)
- Lift capacity 160 kg, including table top, in widened weight.
- Power consumption in standby mode: 0,1 W
- PVC-free system
- PVC-fritt system



VX table tops are available in white alt. grey direct laminate (19 mm particle board), white high pressure laminate (19 mm MDF) and black linoleum (19 mm MDF). Comes with 2 cable entries including plastic cover in white or black.

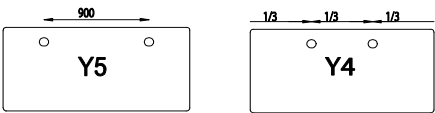
VX11 electric stand:

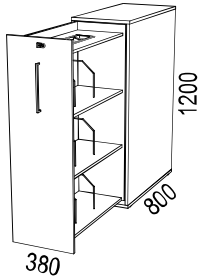
- Range 65 cm (table height 61-126 cm)
- Colours: white (RAL9016) / black (RAL9005)
- Flexible frame 1156-1756 mm (svart RAL9005)
- Lift capacity 160 kg, including table top, in widened weight.
- Power consumption in standby mode: 0,1 W
- PVC-free system
- With built-in anti-collision function (DS1)



For additional product information: please see www.horreds.se

Desk tops A-Frame	Artikelnr	White HPL (31)	Black linoleum (88)
A-Frame table top 1600x800 mm	64xx1607550V	477	652
A-Frame table top 1400x800 mm	64xx1607742V	477	652
Electric stand A-frame	Artikelnr	Vit (31)	Svart (37)
Electr. legs, range 50 (70-120 cm) with wooden A-legs in oak	64xx31250-2	1 654	1 654

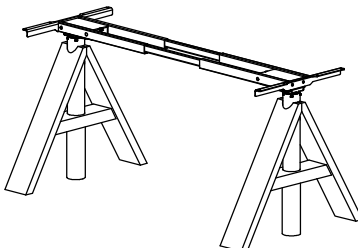
Desk tops VX	Artikelnr	White direct laminate (31S)	Light grey dir.lam. (61S)	Vit HPL laminate (31)	Black linoleum (88)
VX table top 1600x800 mm with 2 st cable holes plac Y5	34xx481-07061	194	261		
VX table top 1400x800 mm with 2 st cable holes plac Y5	34xx481-07297	194	261		
VX table top 1200x800 mm with 2 st cable holes plac Y4	34xx481-07298	182	234		
VX table top 1600x800 mm with 2 st cable holes plac Y5	34xx167025K			446	609
VX table top 1400x800 mm with 2 st cable holes plac Y5	34xx167024K			446	609
VX table top 1200x800 mm with 2 st cable holes plac Y4	34xx167023K			446	609
					
Electric stand VX11	Article nr	White (31)	Black (37)		
VX 11 range 65 cm	VX11xx657-1	549	549		
Accessories	Article no	White (31)	Black (37)		
Cable tray 1100 mm (for table tops 1600 och 1400 mm)	29xx140	102	102		
Cable tray 800 mm (for table tops 1200 mm)	29xx142	102	102		

Side storage	Article nr	White
<p>Choose colour of handle: white, black or stainless steel look</p>  <p>VX side storage 380x1200x800 mm. White dir.laminate, incl pen holder and brackets. Left or right. (Illustration shows left)</p>	343121B	1 077

A-Frame Design: Anderssen & Voll**A-FRAME**

- A-Frame desk tops are made of 19 mm MDF with straight edge.
 - Radius 0.
 - Shape rectangular
 - Cable lid in same material as table top as option. Placed on left side as standard. om inget annat anges vid beställningstillfället.
 - **High Pressure laminate:**

White HPL (lam 0754)	Closest NCS: S0502-Y
Light grey HPL (optional lam 0419)	S2002-Y
Light grey HPL (optional lam 1365)	S2005-R80B
Medium grey HPL (opt. lam. 1023)	S5500-N
Anthracite HPL (opt. lam. 1397)	S7500-N
Black HPL (optional lam 2253)	S9000-N
 - **Linoleum from Forbo Flooring:**

4132 Ash	5502-G
4154 Burgundy	7010-R10B
4166 Charcoal	8502-B
4172 Mauve	7005-Y80R
4174 Conifer	8010-B90G
4175 Pebble	3502-Y
4176 Mushroom	2002-Y
4177 Vapour	2005-G10Y
4179 Smokey Blue	7010-R90B
4184 Olive	5010-G50Y
 - **Veneer group 1:**
 - Oak nature (03)
 - Ash nature (06)
 - **Veneer group 2:**
 - White pigmented oak (30)
 - White pigmented ash (10)
 - Black stained ash (86)
 - Dark stained ash (76)
 - Burgundy stained ash (C8)
 - Conifer stained ash (D3)
 - Smokey Blue stained ash (D4)
- 
- Electric stand, range 50 cm (desk height 70-120 cm). Electric legs in white (RAL 9016) or black (RAL 9005), with solid wooden A-legs in oak or ash.
 - Fixed stand, desk height 73 cm. Metal leg in white or black with solid wooden A-legs in oak or ash.
 - Brackets information is referring to the desk height (incl the table top)
 - Horreds height adjustment control (touchpad) milled in desk top as option.
 - For additional product information please see www.horreds.se

A-Frame Design: Anderssen & Voll

B

Desks within size 2000x900 mm

Note: Separate prices top tops and stands.

Select first the table top, then add price for stand and options.

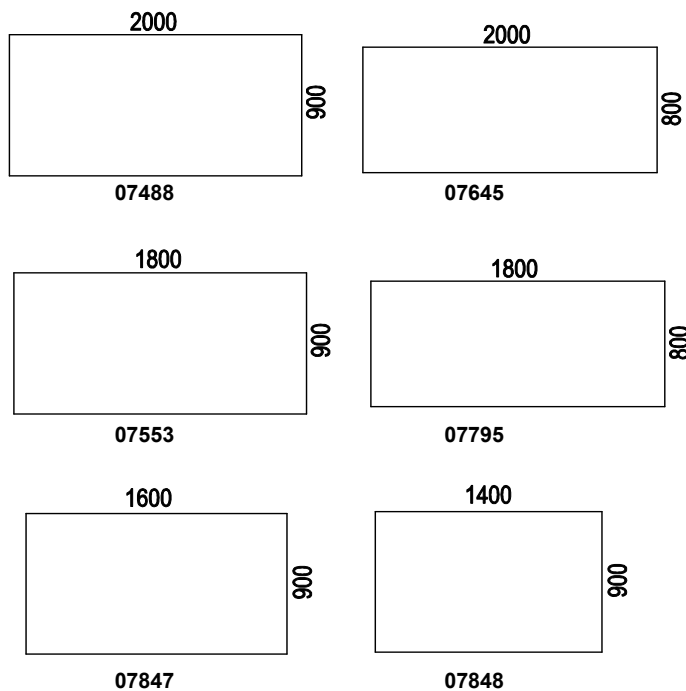
The table's drawing number is listed under the table symbol.

Desk top	Article no	White HPL (31)	Optional HPL (39)	Linoleum (88)	Veneer group 1	Veneer Group 2
A-Frame desk top in B-format	64xx16xxxxB	516	633	752	522	522

Stands	Article no	Solid wood A-legs with white legs	Solid wood A-legs with black legs
Electric stand range 50 cm (70-120) with solid A-legs in oak or ash (nature/stained/white pigmented)	64xx31250-x 64xx37250-x	1 654	1 654
Fixed stand (desk height 73 cm) with solid A-legs in oak or ash (nature/stained/white pigmented)	64xx31200-x 64xx37200-x	985	985

Options:		Upcharge:
Cable lid	64xx07438	152
Horreds touch pad	343707444	55
Veneered edge on laminate table		104
Veneered edge on linoleum table*		104

* only oak/ash nature + white pigmented (not stained).



A-Frame Design: Anderssen & Voll

E Desks within size 1600x800 mm

Note: Separate prices top tops and stands.

Select first the table top, then add price for stand and options.
The table's drawing number is listed under the table symbol.

Desk top	Article no	White HPL (31)	Optional HPL (39)	Linoleum (88)	Veneer group 1	Veneer Group 2
A-Frame desk top in E-format	64xx16xxxxE	477	534	652	497	497

Stands	Article no	Solid wood A-legs with white legs	Solid wood A-legs with black legs
Electric stand range 50 cm (70-120) with solid A-legs in oak or ash (nature/stained/white pigmented)	64xx31250-x 64xx37250-x	1 654	1 654
Fixed stand (desk height 73 cm) with solid A-legs in oak or ash (nature/stained/white pigmented)	64xx31200-x 64xx37200-x	985	985

Options:		Upcharge:
Cable lid	64xx07438	152
Horreds touch pad	343707444	55
Veneered edge on laminate table		104
Veneered edge on linoleum table*		104

* only oak/ash nature + white pigmented (not stained).

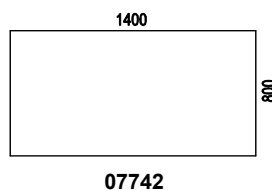
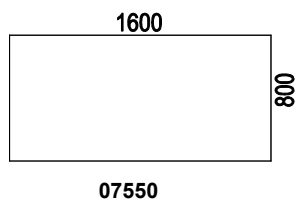



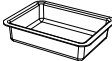





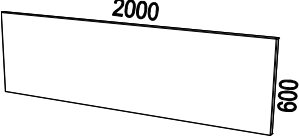
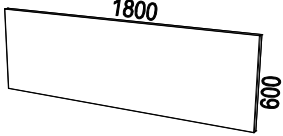
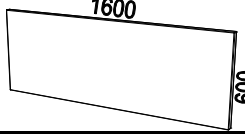
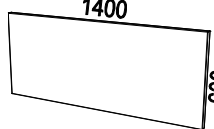

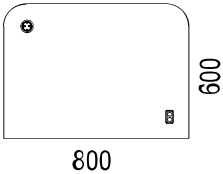
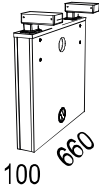
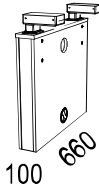
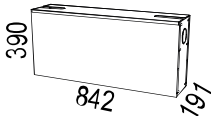
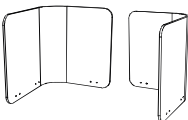
Illustration	Description	Article number	Material	EUR	
A-Frame Design: Anderssen & Voll					
A-Frame ACCESSORIES		RAL colours:			
		31 White	RAL 9016 str		
		37 Black	RAL 9005 str		
	Cable entry including lid 250x150 mm in same material as the desk top. Note: no matching of veneer.	64 31 07438 64 xx 07438 64 xx 07438 64 xx 07438 64 xx 07438	White HPL Optional HPL Linoleum Oak / ash Stained/pigm.	152 152 152 152 152	
	Cable tray in felt 300x220x80 mm	64 98 07403-1	Anthracite	75	
	Shelf in wood , ø 250 mm, höjd 150 mm	64 03 08990 64 D5 08990 64 xx 08990	Oak Hard vax oiled oak Veneer gr 2	266 266 266	
	Shelf in wood, ø 250 mm, incl metal bracket in black or white	64 xxxx 08992 64 xxxx 08992	Hard vax oiled oak Veneer gr 2	257 257	
	Shelf in metal, ø 250 mm, höjd 135 mm	64 31 07430 64 37 07430	White Black	266 266	
	Shelf in metall, ø 250 mm, incl.bracket	64 31 07429 64 37 07429	White Black	257 257	
	3-way power outlet, with bracket	34 37 07434	Black	97	
A-frame SOUND ABSORBING DESK SCREEN					
<ul style="list-style-type: none"> • For mounting in desk top • Thickness approx. 35 mm, of which 30 mm sound absorber • Height over desk: 500 mm • Brackets to be ordered separately • For fabric codes: please see the supplier's website 					
Price group 1:		Price group 2:		Price group 3:	
<u>Camira:</u> Cara, Carlow		<u>Camira:</u> Blazer Lite		<u>Camira:</u> Blazer, Main Line Flax	
<u>Gabriel:</u> Event Screen, Hush		<u>Gabriel:</u> Soul, Soul Mel., Twist, Twist Mel.		<u>Gabriel:</u> Step Melange Screen	
		<u>Focus Melange Screen, Cura Screen</u>		<u>Kvadrat:</u> Remix, Remix Screen, Floyd Screen	
<u>Kvadrat:</u> Hint					
	Sound absorbing desk screen, excluding brackets, length 2000 mm	64 97 82000-x	PG 1 PG 2 PG 3	541 629 700	
	Brackets	34 37 06794-4	svart	93	
	Sound absorbing desk screen, excluding brackets, length 1800 mm	64 97 81800-x	PG 1 PG 2 PG 3	479 559 623	
	Brackets	34 37 06794-4	svart	93	
	Sound absorbing desk screen, excluding brackets, length 1600 mm	64 97 81600-x	PG 1 PG 2 PG 3	453 525 582	
	Brackets	34 37 06794-4	svart	93	
	Sound absorbing desk screen, excluding brackets, length 1400 mm	64 97 81400-x	PG 1 PG 2 PG 3	409 465 534	
	Brackets	34 37 06794-4	svart	93	

Illustration	Description	Articel number	Material	EUR
Nomono Compact Design: Fredrik Mattson				
 <p>Nomono Compact DESK SYSTEM</p> <ul style="list-style-type: none"> • Nomono Compact table top is made of 19mm MDF with matching edging. • Electrically adjustable table height 70-120cm. • Choose the colour of the electric legs and visible steel and plastic details on legs boxes; black or white. • Deskscreen in moulded felt; anthrazite or upholstered. • For more product information www.horreds.se <p><u>Veneer gr 1:</u> Oak (03), Ash (06). <u>Veneer gr 2:</u> White pigm. oak (30), White pigm.ash (10), Black stained ash (86), Dark stained ash (76), Burgundy stained ash (C8), Conifer stained ash (D3), Smokey blue stained ash (D4). <u>White HPL:</u> Closest NCS S0502-Y (31) <u>Optional HPL:</u> Light grey 0419 (2A), light grey 1365 (2B), medium grey 1023 (2C), anthracite 1397 (2D), black F2253 (2E) <u>Linoleum:</u> 4132 Ash (1B), 4154 Burgundy (1C), 4166 Charcoal (1G), 4172 Mauve (1U), 4174 Conifer (1H), 4175 Pebble (1I), 4176 Mushroom (1J), 4177 Vapour (1K), 4179 Smokey Blue (1M), 4184 Olive (1R).</p>				
	Desk top 800x600mm R100 rear corner. Including 1 black Powerdot (PM50) and black moulded hand control.	53 xxz 09254H	White HPL Optional HPL Linoleum Veneer gr 1 Veneer gr 2	534 583 766 672 672
	Leg box / outer gable 660x610x100mm Incl.electric legs, black or white	53 xxz 09255	White dir.lam. Veneer gr 1 Veneer gr 2	933 1 154 1 154
	Leg box / centre gable 660x610x100mm Incl.electric legs, black or white.	53 xxz 09292	White dir.lam. Veneer gr 1 Veneer gr 2	933 1 154 1 154
	Cable tray 842x390x191mm including 2 x 6way power sockets.	53 xxz 09260	White dir.lam. Veneer gr 1 Veneer gr 2	585 659 659
	Metal cover for cable tray.	53 37 09274 53 31 09274	Black White	79 79
	Desk screen 2 pieces (5309324H+5309324V) including 2 sets of fittings (2x533709312-3), black.		Felt anthrazite Camira Blazer Cami. Blazer Lite Camira Synergy Kvadrat Hero Kv. Hero Heather	493 716 716 776 896 896
	Cable sock ø 20mm in braied textile. Length 1500 mm. With zipper.	32 54 000109 32 54 000101	Black White	39 39

PRICE EXAMPLE

• Below prices are based on white laminate/white direct laminate and screen in moulded felt.

A. 4-group without screens



Table top 800x600mm	53 xxy 09254H	4	534	2 136
Leg box / outer gable 660x610x100mm	53 xxy 09255	2	933	1 866
Cable tray 842x390x191	53 xxz 09260	1	585	585
Cover for cable tray	53 xx 09274	1	79	79
Totalt				4 666

B. 4-grupp with screens



Like A above		1	4666	4 666
Screen left, grey moulded felt	53 09324V-xxx	4	175	700
Screen right, grey moulded felt	53 09324H-xxx	4	175	700
Screen fittings	53 37 09312-3	8	71	568
Totalt				6 634

C. 6-group without screens

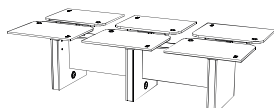
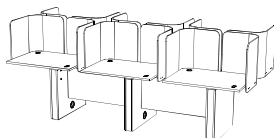


Table top 800x600mm	53 xxy 09254H	6	534	3 204
Leg box / outer gable 660x610x100mm	53 xxy 09255	2	933	1 866
Leg box / centre gable 660x610x100mm	53 xxy 09292	1	933	933
Cable tray 842x390x191	53 xxy 09260	2	585	1 170
Cover for cable tray	53 xx 09274	2	79	158
Totalt				7 331

D. 6-group with screens



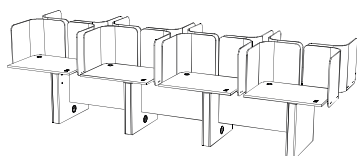
Like C above		1	7331	7 331
Screen left, grey moulded felt	53 09324V-xxx	6	175	1 050
Screen right, grey moulded felt	53 09324H-xxx	6	175	1 050
Screen fittings	53 37 09312-3	12	71	852
Totalt				10 283

E. 8-group without screens



Table top 800x600mm	53 xxy 09254H	8	534	4 272
Leg box / outer gable 660x610x100mm	53 xxy 09255	2	933	1 866
Leg box / centre gable 660x610x100mm	53 xxy 09292	2	933	1 866
Cable tray 842x390x191	53 xxy 09260	3	585	1 755
Cover for cable tray	53 xx 09274	3	79	237
Totalt				9 996

F. 8-group with screens



Like E above		1	9996	9 996
Screen left, grey moulded felt	53 09324V-xxx	8	175	1 400
Screen right, grey moulded felt	53 09324H-xxx	8	175	1 400
Screen fittings	53 37 09312-3	16	71	1 136
Totalt				13 932

Nomono



NOMONO is specially designed to work in open plan offices.

Its clear and firm horizontal tables calms down an environment can sometimes be perceived as a bit chaotic with the desktop screens at different altitudes. The legs have covered sides to further tidy up the office.

In Nomono there are integrated cable boxes that hide the cable clutter that usually occurs in an office. The box is handy for laptop, ipod or phone charger. It can also be equipped with a USB or other technology that connects the office.

Nomono has also another type of leg, a more classic height-adjustable leg, we call it Nomono T. Everything to make it possible to use Nomono in all kinds of environments and offices.

It is important that the workplace may look different. You can choose the accessories you want and color after taste or to suit the corporate image.

Nomono is truly worked out in every detail. A reliable, highly competent and attractive fellow worker.

Design: Fredrik Mattson

5520

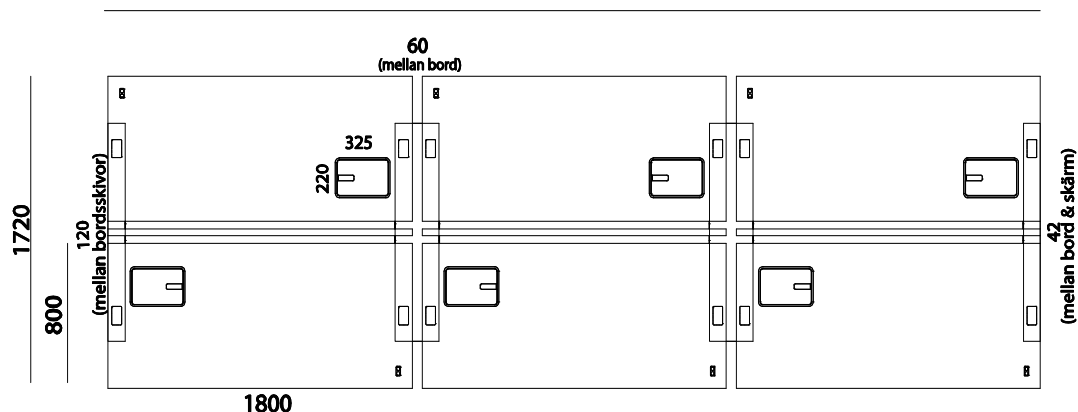


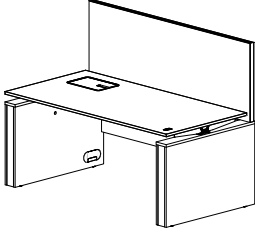
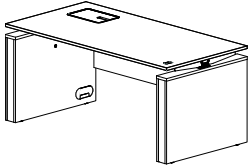
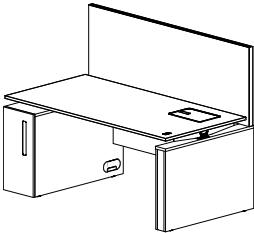
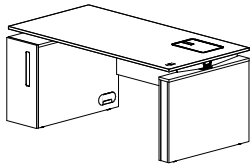
Illustration	Description	Article number	Pcs	Price/ piece	EUR	
Nomono Design: Fredrik Mattson						
Nomono ARRANGEMENTS						
<p>• We have in the examples below made use of desk tops 1800x800 mm in white laminate. If you choose a different size of desk top, please make sure to adjust to correct size of desk screen, cable etc as well.</p>						
A. <u>Single desk</u>						
	Desk top 1800x800	53 31	5303SEK	1	1002	1 002
	Gable 880x100 mm	53 31	W2500V/H	2	1085	2 170
	Desk screen, fabric in price group 1	34 97	06632-x	1	437	437
	Screen brackets	53 37	01069	1	126	126
	Cable box	53 31	5300xx	1	293	293
	Front panel	53 31	80184	1	264	264
	Cable tray	53 31	03790-2	1	237	237
	Total					4 529
B. <u>Single desk</u>						
	Desk top 1800x800	53 31	5303SEK	1	1002	1 002
	Gable 800x100 mm	53 31	W02445V/H	2	1027	2 054
	Cable box	53 31	5300xx	1	293	293
	Front panel	53 31	80184	1	264	264
	Cable tray	53 31	03790-2	1	237	237
	Total					3 850
C. <u>Singelplats med boxförvaring</u>						
	Desk top 1800x800	53 31	5322SEK	1	1002	1 002
	Gable 880x100 mm, right	53 31	W02500H	1	1085	1 085
	Gable 880x300 with storage, left	53 31xx	W02505V	1	1496	1 496
	Desk screen, fabric in price group 1	34 97	06632-x	1	437	437
	Screen brackets	53 37	01069	1	126	126
	Cable box	53 31	5300xx	1	293	293
	Cable tray	53 31	03790-2	1	237	237
	Total					4 676
D. <u>Single desk with storage</u>						
	Desk top 1800x800	53 31	5322SEK	1	1002	1 002
	Gable 800x100 mm, right	53 31	W02445H	1	1027	1 027
	Gable 800x300 with storage, left	53 31xx	W02450V	1	1437	1 437
	Cable box	53 31	5300xx	1	293	293
	Cable tray	53 31	03790-2	1	237	237
	Total					3 996

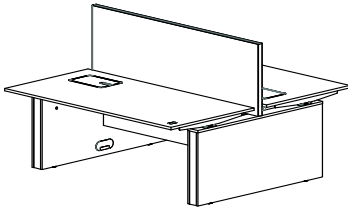
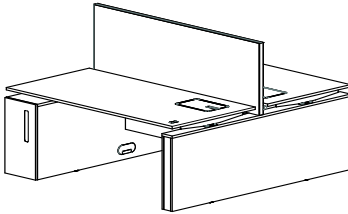
Illustration	Description	Article number	Pcs	Price/ piece	EUR
E. 2-group					
					
	Desk top 1800x800	53 31 5303SEK	2	1002	2 004
	Gable 1200x100 mm	53 31 W02460	2	1525	3 050
	Desk screen, fabric in price group 1	34 97 06632-x	1	437	437
	Screen brackets	53 37 01069	1	126	126
	Cable tray	53 31 03790-4	1	283	283
	Cable box	53 31 5300xx	2	293	586
	Mittpanel	53 31 02490-3	1	169	169
	Total				6 655
F. 2-group with storage					
					
	Desktop 1800x800	53 31 5303SEK	1	1002	1 002
	Desktop 1800x800	53 31 5322SEK	1	1002	1 002
	Gable 1720x100 mm	53 31 W02470	1	1555	1 555
	Gable 1720x300 mm with storage	53 31xx W02485	1	2230	2 230
	Desk screen, fabric in price group 1	34 97 06632-x	1	437	437
	Screen brackets	53 37 01069	1	126	126
	Cable tray	53 31 03790-4	1	283	283
	Cable box	53 31 5300xx	2	293	586
	Total				7 221

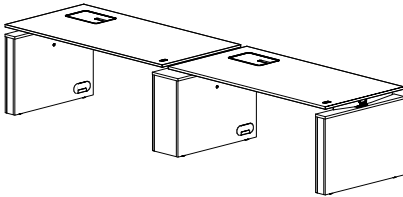
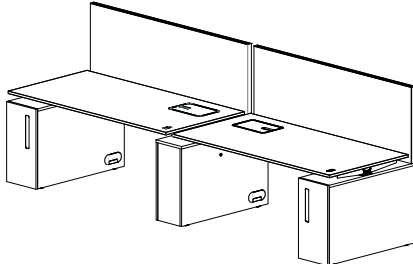
Illustration	Description	Article number	Pcs	Price/ piece	EUR
G1. <u>2-group side by side</u>					
					
	Desk top 1800x800	53 31 5303SEK	2	1002	2 004
	Gable 800x100 mm	53 31 W02445V/H	2	1027	2 054
	Gable 800x260 mm	53 31 W02455	1	1525	1 525
	Cable box	53 31 5300xx	2	293	586
	Cable tray	53 31 03790-2	2	237	474
	Total				<u>6 643</u>
G2. <u>2-group side by side with storage</u>					
					
	Desk top 1800x800	53 31 5303SEK	1	1002	1 002
	Desk top 1800x800	53 31 5322SEK	1	1002	1 002
	Gable 880x300 with storage	53 31 W02505V/H	2	1496	2 992
	Gable 880x260 mm	53 31 W03075	1	1584	1 584
	Desk screen, fabric in price group 1	34 97 06632-x	2	437	874
	Screen brackets	53 37 01069	2	126	252
	Cable box	53 31 5300xx	2	293	586
	Cable tray	53 31 03790-2	2	237	474
	Total				<u>8 766</u>

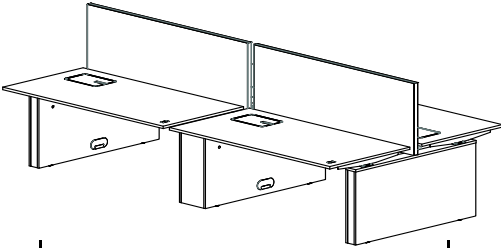
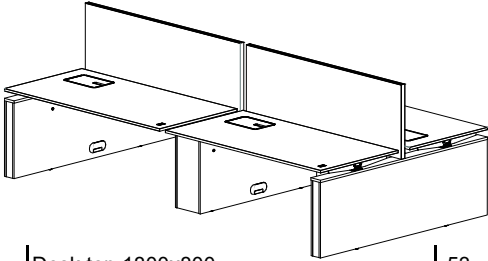
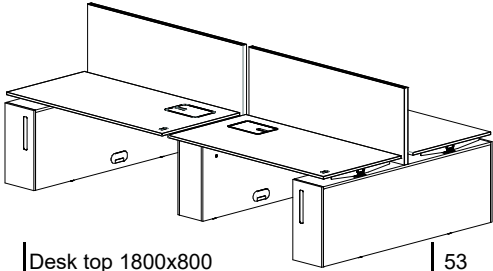
Illustration	Description	Article number	Pcs	Price/ piece	EUR
H. 4-group (with gables 1200 mm)					
					
	Desk top 1800x800	53 31 5303SEK	4	1002	4 008
	Gable 1200x100 mm	53 31 W02460	2	1525	3 050
	Gable 1200x260 mm	53 31 W02465	1	2318	2 318
	Desk screen, fabric in price group 1	34 97 06632-x	2	437	874
	Screen brackets	53 37 01069	2	126	252
	Cable tray	53 31 03790-4	2	283	566
	Cable box	53 31 5300xx	4	293	1 172
	Total				12 240
I. 4-group (with outer gables 1720 mm)					
					
	Desk top 1800x800	53 31 5303SEK	4	1002	4 008
	Gable 1720x100	53 31 W02470	2	1555	3 110
	Gable 1200x260 mm	53 31 W02465	1	2318	2 318
	Desk screen, fabric in price group 1	34 97 06632-x	2	437	874
	Screen brackets	53 37 01069	2	126	252
	Cable tray	53 31 03790-4	2	283	566
	Cable box	53 31 5300xx	4	293	1 172
	Total				12 300
J. 4-grup with storage					
					
	Desk top 1800x800	53 31 5303SEK	2	1002	2 004
	Desk top 1800x800	53 31 5322SEK	2	1002	2 004
	Gable 1720x300 with storage	53 31xx W02485	2	2230	4 460
	Gable 1200x260	53 31 W02465	1	2318	2 318
	Desk screen, fabric in price group 1	34 97 06632-x	2	437	874
	Screen brackets	53 37 01069	2	126	252
	Cable tray	53 31 03790-4	2	283	566
	Cable box	53 31 5300xx	4	293	1 172
	Total				13 650

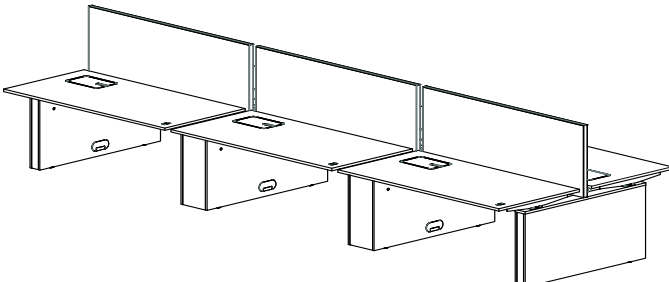
Illustration	Description	Article number	Pcs	Price/ piece	EUR
K. 6-group					
					
	Desk top 1800x800	53 31 5303SEK	6	1002	6 012
	Gable 1200x100 mm	53 31 W02460	2	1525	3 050
	Gable 1200x260 mm	53 31 W02465	2	2318	4 636
	Desk screen, fabric in price group 1	34 97 06632-x	3	437	1 311
	Screen brackets	53 37 01069	3	126	378
	Cable tray	53 31 03790-4	3	283	849
	Cable box	53 31 5300xx	6	293	1 758
	Total				17 994



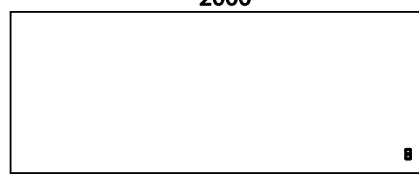
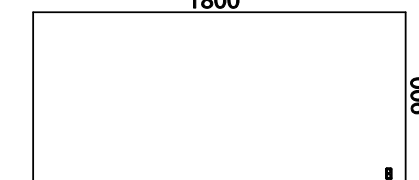
Illustration	Description	Article number	Material	EUR		
<p>Nomono Design: Fredrik Mattson </p>						
<p>Nomono DESK TOPS</p> <ul style="list-style-type: none"> Nomono desk tops are made of 19 mm MDF. Radius 0. Gables not included in below prices. Order separately. Price for cable lid is not included in below prices. Order separately. For additional product information: please see www.horreds.se <p><u>White HPL:</u> closest NCS S0502-Y <u>Optional HPL:</u> Light grey, medium grey, anthracite and black. <u>Linoleum:</u> 4132 Ash, 4154 Burgundy, 4166 Charcoal, 4172 Mauve, 4174 Conifer, 4175 Pebble, 4176 Mushroom, 4177 Vapour, 4179 Smokey Blue, 4184 Olive. <u>Veneer group 1:</u> Oak (03) / Ash (06) <u>Veneer group 2:</u> White pigmented Oak (30), White pigmented Ash (10), Black stained Ash (86), Dark stained Ash (76), Burgundy stained ash (C8), Conifer stained ash (D3), Smokey Blue stained ash (D4).</p>						
	Desk top 2000x900 mm. Including touchpad, frame and trafo. Prepared for cable box left side	53 31 5306SEK 53 xx 5306SEK 53 xx 5306SEK 53 xx 5306SEK 53 xx 5306SEK	White HPL Optional HPL Linoleum Veneer group 1 Veneer group 2	1 002 1 116 1 201 1 008 1 008		
	Desk top 2000x900 mm. Including touchpad, frame and trafo. Prepared for cable box right side	53 31 5321SEK 53 xx 5321SEK 53 xx 5321SEK 53 xx 5321SEK 53 xx 5321SEK	White HPL Optional HPL Linoleum Veneer group 1 Veneer group 2	1 002 1 116 1 201 1 008 1 008		
		Desk top 2000x800 mm. Including touchpad, frame and trafo. Prepared for cable box left side	53 31 5305SEK 53 xx 5305SEK 53 xx 5305SEK 53 xx 5305SEK	White HPL Optional HPL Linoleum Veneer group 1 Veneer group 2	1 002 1 116 1 201 1 008 1 008	
		Desk top 2000x800 mm. Including touchpad, frame and trafo. Prepared for cable box right side	53 31 5324SEK 53 xx 5324SEK 53 xx 5324SEK 53 xx 5324SEK 53 xx 5324SEK	White HPL Optional HPL Linoleum Veneer group 1 Veneer group 2	1 002 1 116 1 201 1 008 1 008	
			Desk top 1800x900 mm. Including touchpad, frame and trafo. Prepared for cable box left side	53 31 5304SEK 53 xx 5304SEK 53 xx 5304SEK 53 xx 5304SEK	White HPL Optional HPL Linoleum Veneer group 1 Veneer group 2	1 002 1 116 1 201 1 008 1 008
			Desk top 1800x900 mm. Including touchpad, frame and trafo. Prepared for cable box right side	53 31 5318SEK 53 xx 5318SEK 53 xx 5318SEK 53 xx 5318SEK 53 xx 5318SEK	White HPL Optional HPL Linoleum Veneer group 1 Veneer group 2	1 002 1 116 1 201 1 008 1 008





Illustration	Description	Article number	Material	EUR
	Desk top 1800x800 mm.	53 31 5303SEK	White HPL	1 002
	Including touchpad, frame and trafo.	53 xx 5303SEK	Optional HPL	1 116
	Prepared for cable box left side	53 xx 5303SEK	Linoleum	1 201
		53 xx 5303SEK	Veneer group 1	1 008
		53 xx 5303SEK	Veneer group 2	1 008
	Desk top 1800x800 mm.	53 31 5322SEK	White HPL	1 002
	Including touchpad, frame and trafo.	53 xx 5322SEK	Optional HPL	1 116
	Prepared for cable box right side	53 xx 5322SEK	Linoleum	1 201
		53 xx 5322SEK	Veneer group 1	1 008
		53 xx 5322SEK	Veneer group 2	1 008
	Desk top 1600x900 mm.	53 31 5302SEK	White HPL	1 002
	Including touchpad, frame and trafo.	53 xx 5302SEK	Optional HPL	1 116
	Prepared for cable box left side	53 xx 5302SEK	Linoleum	1 201
		53 xx 5302SEK	Veneer group 1	1 008
		53 xx 5302SEK	Veneer group 2	1 008
	Desk top 1600x900 mm.	53 31 5320SEK	White HPL	1 002
	Including touchpad, frame and trafo.	53 xx 5320SEK	Optional HPL	1 116
	Prepared for cable box right side	53 xx 5320SEK	Linoleum	1 201
		53 xx 5320SEK	Veneer group 1	1 008
		53 xx 5320SEK	Veneer group 2	1 008
	Desk top 1600x800 mm.	53 31 5301SEK	White HPL	964
	Including touchpad, frame and trafo.	53 xx 5301SEK	Optional HPL	1 000
	Prepared for cable box left side	53 xx 5301SEK	Linoleum	1 131
		53 xx 5301SEK	Veneer group 1	983
		53 xx 5301SEK	Veneer group 2	983
	Desk top 1600x800 mm.	53 31 5323SEK	White HPL	964
	Including touchpad, frame and trafo.	53 xx 5323SEK	Optional HPL	1 000
	Prepared for cable box right side	53 xx 5323SEK	Linoleum	1 131
		53 xx 5323SEK	Veneer group 1	983
		53 xx 5323SEK	Veneer group 2	983
	Desk top 1400x900 mm.	53 31 5311SEK	White HPL	964
	Including touchpad, frame and trafo.	53 xx 5311SEK	Optional HPL	1 000
	Prepared for cable box left side	53 xx 5311SEK	Linoleum	1 131
		53 xx 5311SEK	Veneer group 1	983
		53 xx 5311SEK	Veneer group 2	983
	Desk top 1400x900 mm.	53 31 5339SEK	White HPL	964
	Including touchpad, frame and trafo.	53 xx 5339SEK	Optional HPL	1 000
	Prepared for cable box right side	53 xx 5339SEK	Linoleum	1 131
		53 xx 5339SEK	Veneer group 1	983
		53 xx 5339SEK	Veneer group 2	983

Illustration	Description	Article number	Material	EUR	
	Desk top 1400x800 mm. Including touchpad, frame and trafo. Prepared for cable box left side	53 31 5312SEK 53 xx 5312SEK 53 xx 5312SEK 53 xx 5312SEK 53 xx 5312SEK	White HPL Optional HPL Linoleum Veneer group 1 Veneer group 2	964 1 000 1 131 983 983	
	Desk top 1400x800 mm. Including touchpad, frame and trafo. Prepared for cable box right side	53 31 5338SEK 53 xx 5338SEK 53 xx 5338SEK 53 xx 5338SEK 53 xx 5338SEK	White HPL Optional HPL Linoleum Veneer group 1 Veneer group 2	964 1 000 1 131 983 983	
	Nomono GABLES				
	Color handles / closest NCS:				
	31 White S 0300-N				
	37 Black S 9000-N				
	32 Yellow S 1070-Y				
	36 Green S 2570-G30Y				
	33 Red S 1580-Y80R				
	35 Turquoise S0540-B30G				
	42 Orange S 1080-Y50R				
	<ul style="list-style-type: none"> • Including electrical legs, adjustable 73-120 cm • Height from floor to top of gable: 618 mm 				
<p><u>Veneer group 1:</u> Oak (03) / Ash (06)</p> <p><u>Veneer group 2:</u> white oak (30), black ash (86), white ash (10), dark ash (76) Burgundy st. ash(C8) Conifer st.ash (D3), Smokey Blue st.ash (D4).</p>					
Options:					
<ul style="list-style-type: none"> • Gable door with lock: additional € 65 / door • Cable hole outer side of gable: additional € 92 / gable • Handles in Elmosoft 54035 Light Brown € 35:- / handle 					
Depth 800 mm - for single desk <u>without</u> desk screen					
	Gable 800x100, left	53 31W 02445V 53 xxX 02445V 53 xxX 02445V	White dir.laminate Veneer group 1 Veneer group 2	1 027 1 467 1 467	
	Gable 800x100, right	53 31W 02445H 53 xxX 02445H 53 xxX 02445H	White dir.laminate Veneer group 1 Veneer group 2	1 027 1 467 1 467	
		Gable 800x300 mm, left, with storage	53 31Wxx 02450V 53 xxXxx 02450V 53 xxXxx 02450V	White dir.laminate Veneer group 1 Veneer group 2	1 437 2 288 2 288
		Gable 800x300 mm, right, with storage	53 31Wxx 02450H 53 xxXxx 02450H 53 xxXxx 02450H	White dir.laminate Veneer group 1 Veneer group 2	1 437 2 288 2 288
			Gable 800x400 mm, left, with withdrawable storage	53 31Wxx 03330V 53 xxXxx 03330V 53 xxXxx 03330V	White dir.laminate Veneer group 1 Veneer group 2
	Gable 800x400 mm, right with withdrawable storage		53 31Wxx 03330H 53 xxXxx 03330H 53 xxXxx 03330H	White dir.laminate Veneer group 1 Veneer group 2	2 171 2 816 2 816
	Gable, middle, 800x260 mm		53 31W 02455 53 xxX 02455 53 xxX 02455	White dir.laminate Veneer group 1 Veneer group 2	1 525 1 995 1 995

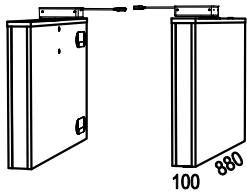
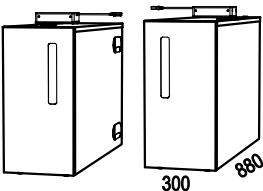
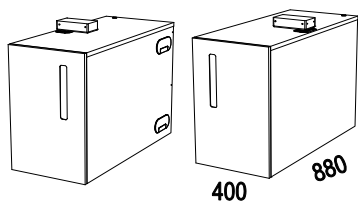
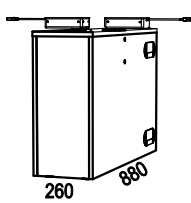
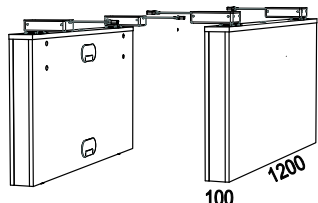
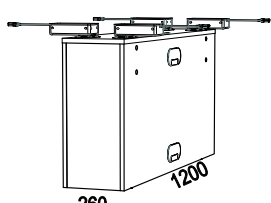
Illustration	Description	Article number	Material	EUR	
Depth 880 mm - for single desk with desk screen					
	Gable 880x100 mm, left	53 31W 02500V 53 xxX 02500V 53 xxX 02500V	White dir.laminate Veneer group 1 Veneer group 2	1 085 1 584 1 584	
	Gable 880x100 mm, right	53 31W 02500H 53 xxX 02500H 53 xxX 02500H	White dir.laminate Veneer group 1 Veneer group 2	1 085 1 584 1 584	
		Gable 880x300 mm, left, with storage	53 31Wxx 02505V 53 xxXxx 02505V 53 xxXxx 02505V	White dir.laminate Veneer group 1 Veneer group 2	1 496 2 406 2 406
		Gable 880x300 mm, right with storage	53 31Wxx 02505H 53 xxXxx 02505H 53 xxXxx 02505H	White dir.laminate Veneer group 1 Veneer group 2	1 496 2 406 2 406
			Gable 880x400 mm, left, with withdrawable storage	53 31Wxx 03955V 53 xxXxx 03955V 53 xxXxx 03955V	White dir.laminate Veneer group 1 Veneer group 2
	Gable 880x400 mm, right, with withdrawable storage		53 31Wxx 03955H 53 xxXxx 03955H 53 xxXxx 03955H	White dir.laminate Veneer group 1 Veneer group 2	2 230 2 934 2 934
	Gable, middle, 880x260 mm		53 31W 03075 53 xxX 03075 53 xxX 03075	White dir.laminate Veneer group 1 Veneer group 2	1 584 2 112 2 112
	Depth 1200 mm				
		Gable 1200x100 mm.	53 31W 02460 53 xxX 02460 53 xxX 02460	White dir.laminate Veneer group 1 Veneer group 2	1 525 2 024 2 024
		Gable, middle, 1200x260 mm.	53 31W 02465 53 xxX 02465 53 xxX 02465	White dir.laminate Veneer group 1 Veneer group 2	2 318 2 816 2 816

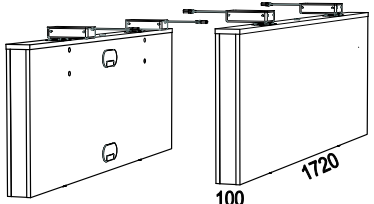
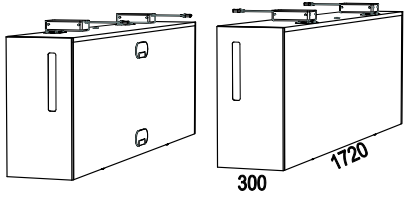
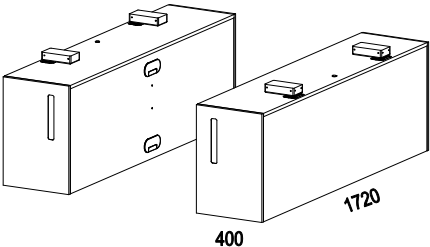
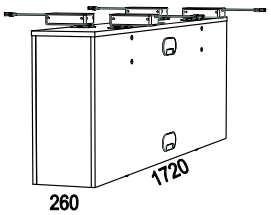
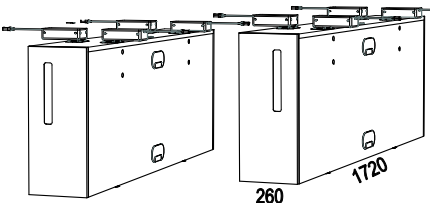
Illustration	Description	Article number	Material	EUR
Depth 1720 mm				
	Gable 1720x100 mm	53 31W 02470 53 xxX 02470 53 xxX 02470	White dir.laminate Veneer group 1 Veneer group 2	1 555 2 054 2 054
	Gable 1720x300 mm, with storage	53 31Wxx 02485 53 xxXxx 02485 53 xxXxx 02485	White dir.laminate Veneer group 1 Veneer group 2	2 230 3 520 3 520
	Gable, 1720x400 mm, with withdrawable storage	53 31Wxx 04024 53 xxXxx 04024 53 xxXxx 04024	White dir.laminate Veneer group 1 Veneer group 2	3 755 4 459 4 459
	Gable, middle, 1720x260 mm	53 31W 02475 53 xxX 02475 53 xxX 02475	White dir.laminate Veneer group 1 Veneer group 2	2 464 3 051 3 051
	Gable, middle, 1720x260 mm, with storage	53 31Wxx 02480 53 xxXxx 02480 53 xxXxx 02480	White dir.laminate Veneer group 1 Veneer group 2	3 081 4 400 4 400



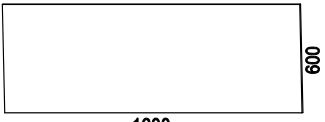
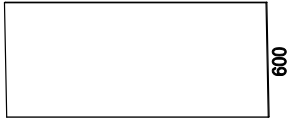
Illustration	Description	Article number	Material	EUR	
<p>Nomono SOUND ABSORBING DESK SCREENS</p> <ul style="list-style-type: none"> • For mounting in gables • Thickness approx.35 mm, of which 30 mm sound absorber • Fixed height from floor: 120 cm. • Brackets to be ordered separately • For fabric codes: please see the supplier's website 					
<p>Price group 1:</p> <p><u>Camira:</u> Cara, Carlow</p> <p><u>Gabriel:</u> Event Screen, Hush</p>		<p>Price group 2:</p> <p><u>Camira:</u> Blazer Lite</p> <p><u>Gabriel:</u> Soul, Soul Mel., Twist, Twist Mel.</p> <p>Focus Melange Screen, Cura Screen</p> <p><u>Kvadrat:</u> Hint</p>		<p>Price group 3:</p> <p><u>Camira:</u> Blazer, Main Line Flax</p> <p><u>Gabriel:</u> Step Melange Screen</p> <p><u>Kvadrat:</u> Remix, Remix Screen, Floyd Screen</p>	
	Sound absorbing desk screen, excluding brackets, length 2000 mm	34 97 04230-x	PG 1	524	
	Brackets	53 37 01069	PG 2 PG 3	619 700	
	Sound absorbing desk screen, excluding brackets, length 1800 mm	34 97 06632-x	PG 1	437	
	Brackets	53 37 01069	PG 2 PG 3	515 583	
	Sound absorbing desk screen, excluding brackets, length 1600 mm	34 97 04207-x	PG 1	377	
	Brackets	53 37 01069	PG 2 PG 3	431 528	
	Sound absorbing desk screen, excluding brackets, length 1400 mm	34 97 07052-x	PG 1	367	
	Brackets	53 37 01069	PG 2 PG 3	420 491	
				126	

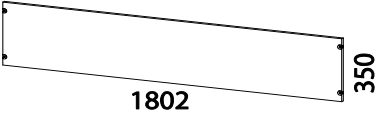
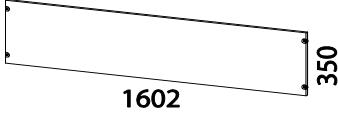
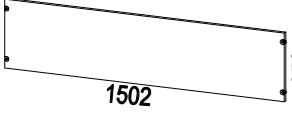

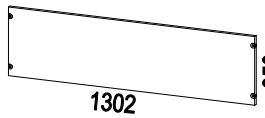
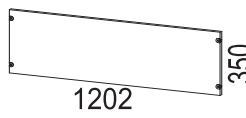
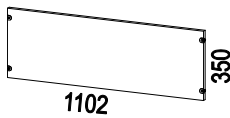
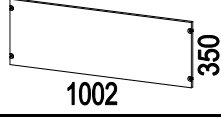

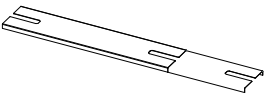

Illustration	Description	Article number	Material	EUR
Nomono FRONT PANELS • Required for single desks with gables without storage in order to obtain sufficient stability. • For single desks with storage the front panels are optional.				
	Front panel 1802x350 mm. For desk: 2000 mm with gables without storage	53 31 80204	White dir.laminate	264
		53 xx 80204	Veneer group 1	411
		53 xx 80204	Veneer group 2	411
	Front panel 1602x350 mm. For desks: 1800 mm with gables without storage 2000 mm with gable storage one side	53 31 80184	White dir.laminate	264
		53 xx 80184	Veneer group 1	411
		53 xx 80184	Veneer group 2	411
	Front panel 1502x350 mm. For desk: 2000 mm with gable with withdrawable storage one side	53 31 80205	White dir.laminate	264
		53 xx 80205	Veneer group 1	411
		53 xx 80205	Veneer group 2	411
	Front panel 1402x350 mm. For desks: 1600 mm with gables without storage 1800 mm with gable w.storage one side	53 31 80164	White dir.laminate	264
		53 xx 80164	Veneer group 1	411
		53 xx 80164	Veneer group 2	411
	Front panel 1302x350 mm. For desk: 1800 mm with gable with withdrawable storage one side	53 31 80185	White dir.laminate	264
		53 xx 80185	Veneer group 1	411
		53 xx 80185	Veneer group 2	411
	Front panel 1202x350 mm. For desks: 1400 mm with gables without storage 1600 mm with gable storage one side	53 31 80144	White dir.laminate	264
		53 xx 80144	Veneer group 1	411
		53 xx 80144	Veneer group 2	411
	Front panel 1102x350 mm. For desk: 1600 mm with gable with withdrawable storage one side	53 31 80165	White dir.laminate	264
		53 xx 80165	Veneer group 1	411
		53 xx 80165	Veneer group 2	411
	Front panel 1002x350 mm. For desk: 1400 mm with gable storage one side	53 31 80124	White dir.laminate	264
		53 xx 80124	Veneer group 1	411
		53 xx 80124	Veneer group 2	411
Nomono MIDDLE PANELS • Required for 2-groups (desks placed opposite each other) with gables without storage in order to obtain sufficient stability.				
	Middle panel 1802x200 mm. For desk 2000 mm with gables without storage	53 31 02490-4	White dir.laminate	169
		53 xx 02490-4	Veneer group 1	262
		53 xx 02490-4	Veneer group 2	262
	Middle panel 1602x200 mm. For desk 1800 mm with gables without storage	53 31 02490-3	White dir.laminate	169
		53 73 02490-3	Veneer group 1	262
		53 xx 02490-3	Veneer group 2	262
	Middle panel 1402x200 mm. For desk 1600 mm with gables without storage	53 31 02490-2	White dir.laminate	169
		53 73 02490-2	Veneer group 1	262
		53 xx 02490-2	Veneer group 2	262
	Middle panel 1202x200 mm. For desk 1400 mm with gables without storage	53 31 02490-1	White dir.laminate	169
		53 73 02490-1	Veneer group 1	262
		53 xx 02490-1	Veneer group 2	262

Illustration	Description	Article number	Material	EUR	
<p>Nomono CABLE TRAYS</p> <p>• Flexible cable tray for mounting in gables</p> <p style="text-align: right;">31 White RAL 9016 37 Black RAL 9005</p>					
	Flexible cable tray to single desks and groups side by side. Incl 2xpower 1 cable tray/desk is required.	53 31 03790-2 53 37 03790-2	White Black	237 237	
	Flexible cable tray for groups with 2 desks opposite each other. Ink'cl. 4xpower. 1 cable tray/2 desks is required.	53 31 03790-4 53 37 03790-4	White Black	283 283	
	<i>Not suitable to desk length 1400 mm with withdrawable gable.</i>				
		Lid for flexible cable tray	53 31 03792 53 37 03792	White Black	90 90
		<p>Nomono CABLE LID</p> <p>• Cable lid made of the same material as the desk top, with MDF edges.</p> <p style="text-align: right;">31 White RAL 9016 37 Black RAL 9005</p>			
		Extra cost for shutter on desk top. Incl. 3-way standard socket and cable pipe in textile.	53 31 5300xx 53 xx 5300xx 53 xx 5300xx 53 xx 5300xx 53 xx 5300xx	White HPL Optional HPL Linoleum Veneer group 1 Veneer group 2	293 293 293 293 293

Nomono T Design: Fredrik Mattson

NOMONO T DESK TOPS



- Choose desk top from format B or E.
- Complete prices including desk top, frame and electrical T-legs.
- Nomono T desk tops are made of 19 mm MDF with straight edge.
- Height adjustment control (touch pad) always on the right side of the desk top.
- Radius 0.
- Shape rectangular
- The cable box is always placed on the left side of the desk top.

• **Desktop from Forbo Flooring:**

4132 Ash	5502-G
4154 Burgundy	7010-R10B
4166 Charcoal	8502-B
4172 Mauve	7005-Y80R
4174 Conifer	8010-B90G
4175 Pebble	3502-Y
4176 Mushroom	2002-Y
4177 Vapour	2005-G10Y
4179 Smokey Blue	7010-R90B
4184 Olive	5010-G50Y

• **Veneer group 1:**

- Oak nature (03)
- Ash nature (06)

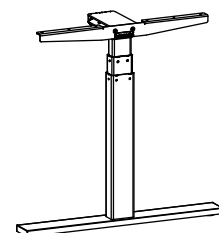
• **Veneer group 2:**

- White pigmented oak (30)
- Black stained ash (86)
- White pigmented ash (10)
- Dark stained ash (76)
- Burgundy stained ash (C8)
- Conifer stained ash (D3)
- Smokey Blue stained ash (D4)

• **High Pressure Laminate:**

	Closest NCS:
White HPL (lam0754)	S0502-Y
Light grey HPL (optional lam 0419)	S2002-Y
Light grey HPL (optional lam 1365)	S2005-R80B
Medium grey HPL (opt. Lam 1023)	S5500-N
Anthracite HPL (opt. lam 1397)	S7500-N
Black HPL (optional lam 2253)	S9000-N

- Electrical T-leg with anti-collision-solution
- Massive feet
- Brackets information is referring to the desk height (inkl the top)
- For additional product information: please see www.horreds.se



Nomono T Design: Fredrik Mattson

B Desks within size 2000x900 mm

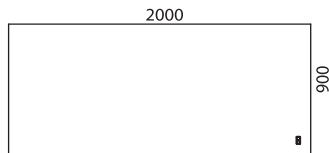
Complete package with desk top, frame and electrical T-legs.

Please replace the first 2 xx in the article number with the material code for the desk top.
Next 4 xxxx should be replaced with the code for the desk (the code under the desk symbol)

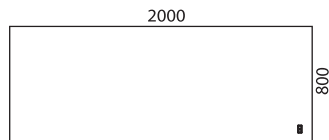
	Colour stand	Article number	White HPL (31)	Optional HPL (39)	Lineoleum (88)	Veneer group 1	Veneer group 2
Desk top incl electrical T-legs (61-126 cm)	White	53B xx xxxxx 31-E	2 183	2 297	2 382	2 189	2 189
	Black	53B xx xxxxx 37-E	2 183	2 297	2 382	2 189	2 189
Desk top only		53B xx xxxxE	521	635	721	528	528

OPTIONS:

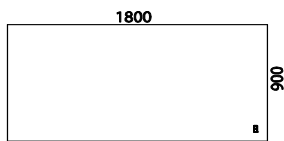
Additional cost for cable box			293	293	293	293	293
-------------------------------	--	--	-----	-----	-----	-----	-----



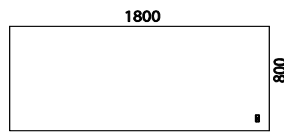
5306E



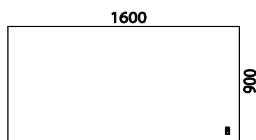
5305E



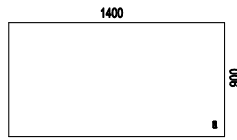
5304E



5303E



5302E



5311E

Nomono T Design: Fredrik Mattson

E Desks within size 1600x800 mm

Complete package with desk top, frame and electrical T-legs.

Please replace the first 2 xx in the article number with the material code for the desk top.
Next 4 xxxx should be replaced with the code for the desk (the code under the desk symbol)

	Colour stand	Article number	White HPL (31)	Optional HPL (39)	Lineoleum (88)	Veneer group 1	Veneer group 2
Desk top incl electrical T-legs (61-126 cm)	White	53E xx xxxxx 31-E	2 145	2 180	2 311	2 164	2 164
	Black	53E xx xxxxx 37-E	2 145	2 180	2 311	2 164	2 164
Desk top only		53E xx xxxxE	484	519	650	502	502

OPTIONS:

Additional cost for cable box			293	293	293	293	293
-------------------------------	--	--	-----	-----	-----	-----	-----

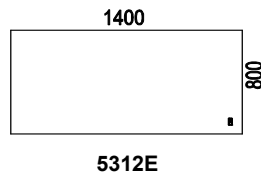
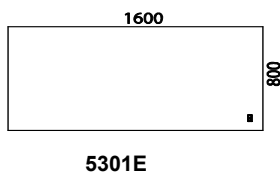
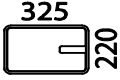
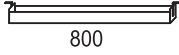
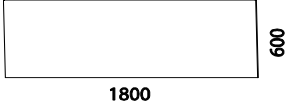
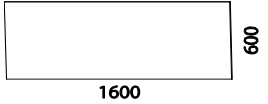
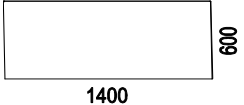


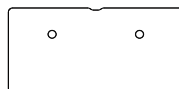
Illustration	Description	Article number	Material	Pris	
Nomono T Design: Fredrik Mattson					
<p>Nomono T ACCESSORIES</p> <p>The cable lid is made of the same material as the desk top, with MDF edges.</p>					
	Extra cost for shutter on desk top.	53 31 5300xx	White HPL	293	
	Incl. 3-way standard socket and cable pipe in textile.	53 39 5300xx	Optional HPL	293	
		53 88 5300xx	Lineleum	293	
		53 xx 5300xx	Veneer gr 1	293	
		53 xx 5300xx	Veneer gr 2	293	
	Cable tray. Length 800 mm.	29 31 142	White	102	
	Adjustable in 3 heights	29 37 142	Black	102	
<p>Nomono T FABRIC DESK SCREENS</p> <ul style="list-style-type: none"> • For mounting in desk top • Thickness approx. 35 mm, of which 30 mm are sound absorbent • Height over desk: 450 mm • Brackets to be ordered separately. • For fabric codes: please see the supplier's website 					
<p>Price group 1: <u>Camira:</u> Cara, Carlow <u>Gabriel:</u> Event Screen, Hush</p>		<p>Price group 2: <u>Camira:</u> Blazer Lite <u>Gabriel:</u> Soul, Soul Mel., Twist, Twist Mel. Focus Melange Screen, Cura Screen <u>Kvadrat:</u> Hint</p>		<p>Price group 3: <u>Camira:</u> Blazer, Main Line Flax <u>Gabriel:</u> Step Melange Screen <u>Kvadrat:</u> Remix, Remix Screen, Floyd Screen</p>	
	Sound absorbing desk screen, Length 1800 mm, excluding brackets	34 97 81800-x	PG 1	380	
	Brackets	34 37 06794-4	PG 2	459	
	Sound absorbing desk screen, Length 1600 mm, excluding brackets	34 97 81600-x	PG 3	526	
	Brackets	34 37 06794-4	svart	93	
	Sound absorbing desk screen, Length 1400 mm, excluding brackets	34 97 81400-x	PG 1	320	
	Brackets	34 37 06794-4	PG 2	374	
			PG 3	471	
			svart	93	
			PG 1	309	
			PG 2	364	
			PG 3	434	
			svart	93	

Siglo Design: Henrik Schulz**Siglo** DESK TOPS

- Siglo desk tops in veneer, laminate and linoleum are made of 19 mm MDF with a straight pp-edge. White edge to veneer and matching edge to laminate and linoleum. Additional cost for chamfered edge.
- Siglo desk tops in white direct lam. are made of 19 mm particle board with straight pp-edge.
- Radius 35 mm.
- Siglo has a cut-out for cables as standard. Cable holes against additional fee.

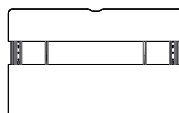
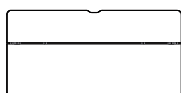


Standard



Med kabelhål (tillval)

- Electric stand, VX11, to be ordered separately. White, black and silver, range 65 cm.
- Siglo sliding tops are always delivered with chamfered edge (included in the price). Veneered tops always have a clear varnished MDF edge. Tops in laminate and linoleum have matching plastic edge. Electric stand and cable tray in felt is included.

• **Linoleum Forbo Flooring:**

	Closest NCS:
4132 Ash (1B)	5502-G
4154 Burgundy (1C)	7010-R10B
4166 Charcoal (1G)	8502-B
4172 Mauve (1U)	7005-Y80R
4174 Conifer (1H)	8010-B90G
4175 Pebble (1I)	3502-Y
4176 Mushroom (1J)	2002-Y
4177 Vapour (1K)	2005-G10Y
4179 Smokey Blue (1M)	7010-R90B
4184 Olive (1R)	5010-G50Y

• **High Pressure laminate:**

	Closest NCS:
White HPL (standard 0754)	S0502-Y
Light grey HPL (opt. lam 0419)	S2002-Y
Light grey HPL (opt. lam 1365)	S2005-R80B
Medium grey HPL (opt. lam 1023)	S5500-N
Anthracite HPL (opt. lam 1397)	S7500-N
Black HPL (optional lam 2253)	S9000-N

• **Veneer group 1:**

Ek natur (03)
Ask natur (06)

• **Veneer group 2:**

Vitpigmenterad ek (30)
Vitpigmenterad ask (10)
Svartbetsad ask (86)
Mörkbetsad ask (76)
Burgundy betsad ask (C8)
Conifer betsad ask (D3)
Smokey Blue betsad ask (D4)

- For additional product information please see www.horreds.se

Siglo Design: Henrik Schulz

B

Desks within size 1800x900 mm.

Desk tops Siglo with cut-out for cables.

Electric stand VX11 to be ordered separately.

Replace the first 2 xx in the article number with the material code for desk top.

Next 5 xxxxx should be replaced with the code for the desk required (the code under the desk symbol)

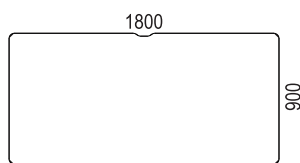
Desk tops Siglo:	Artikelnummer	White direct lam. (31D)	White HPL (31)	Optional HPL (39)	Lino-leum (88)	Veneer group 1	White oak (30) White ash (10) *
Siglo desk top	60B xx 16-xxxxx	310	453	549	701	425	425
* Stained only available with chamfered edge, additional cost:							86

Electric stand:

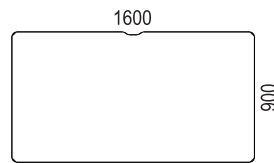
VX11, see Page 42

Options:

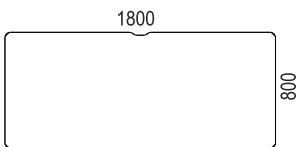
Chamfered edge Note: not in combination with direct laminate		20	86
Touchpad milled into desk top		343707444	55
Cable holes, incl. 2 lids, white/black	Plastic	60xx03118x2	150
Cable holes, incl. 2 lids	Brass	601603118x2	241
Cable holes, incl. 2 lids	Stainless	601703118x2	241



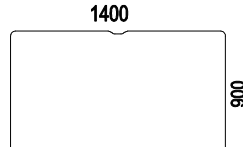
03436



03438



03435



03462

Siglo Design: Henrik Schulz

E Desks within size 1600x800 mm.

Desk tops Siglo with cut-out for cables.
Electric stand VX11 to be ordered separately.

Replace the first 2 xx in the article number with the material code for desk top.
Next 5 xxxxx should be replaced with the code for the desk required (the code under the desk symbol)

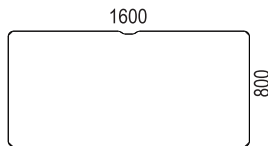
Desk tops Siglo:	Artikelnummer	White direct lam. (31D)	White HPL (31)	Optional HPL (39)	Lino-leum (88)	Veneer group 1	White oak (30) White ash (10) *
Siglo desk top	60E xx 16-xxxxx	299	397	461	650	397	397
* Stained only available with chamfered edge, additional cost:							86

Electric stand:

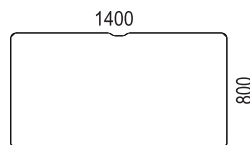
VX11, see page 42

Options:

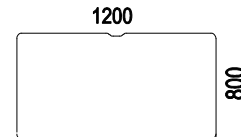
Chamfered edge Note: not in combination with direct laminate		20	86
Touchpad milled into desk top		343707444	55
Cable holes, incl. 2 lids, white/black	Plastic	60xx03118x2	150
Cable holes, incl. 2 lids	Brass	601603118x2	241
Cable holes, incl. 2 lids	Stainless	601703118x2	241



03115



03461

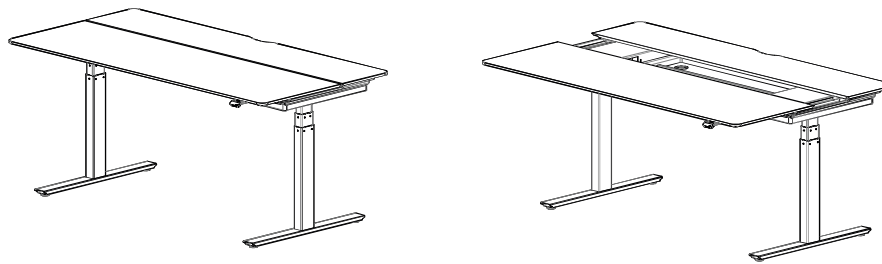


03950*

* not available with chamfered edge

Siglo Design: Henrik Schulz

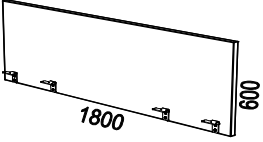
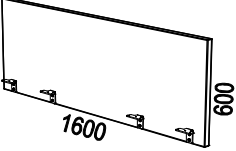
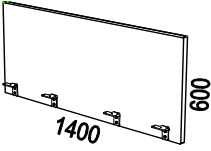
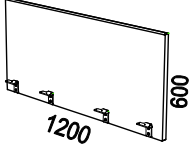
S Sliding desk



Complete package including sliding desk top with chamfered edge, frame, electrical T-legs VX8 and grey felt box.

xx in the article number should be replaced with the material code for the desk top.

		Article number	White direct lam. (31D)	White HPL (31)	Optional HPL (39)	Lino-leum (88)	Veneer group 1	Veneer group 2
1800x800:								
Sliding top 1800x800 with electrical adjustable T-legs (61-126 cm)* and grey felt box (art 6003609-2)	White	60B xx 20-03615-31S65		3 253	3 392	3 444	3 128	3 128
	Black	60B xx 20-03615-37S65		3 253	3 392	3 444	3 128	3 128
	Silver	60B xx 20-03615-38S65		3 253	3 392	3 444	3 128	3 128
1600x800:								
Sliding top 1600x800 with electrical adjustable T-legs (61-126 cm)* and grey felt box (art 6003608-2)	White	60E xx 20-03614-31S65		3 166	3 243	3 312	3 041	3 041
	Black	60E xx 20-03614-37S65		3 166	3 243	3 312	3 041	3 041
	Silver	60E xx 20-03614-38S65		3 166	3 243	3 312	3 041	3 041
1400x800:								
Sliding top 1400x800 with electrical adjustable T-legs (61-126 cm)* and grey felt box (art 6003607-2)	White	60E xx 20-03613-31S65		3 144	3 221	3 290	3 019	3 019
	Black	60E xx 20-03613-37S65		3 144	3 221	3 290	3 019	3 019
	Silver	60E xx 20-03613-38S65		3 144	3 221	3 290	3 019	3 019
Options:								
Electronic lock Mifare 13,56 Mhzfor sliding desk incl 1 user card (also includes 1 program card 371401 and 1 service card 371501 per order)		60372020		438				
Extra user card		371781		17				

Illustration	Description	Article number	EUR			
Siglo Design: Henrik Schulz						
<p>Siglo SOUND ABSORBING DESK SCREEN</p> <ul style="list-style-type: none"> • Height 600 mm (of which 500 mm over desk) • Thickness 35mm • Including black fittings • 3 different price groups • Also fits sliding desk • For additional product information; please see www.horreds.se 						
<p>Price group 1: <u>Camira:</u> Cara, Carlow <u>Gabriel:</u> Event Screen, Hush</p>		<p>Price group 2: <u>Camira:</u> Blazer Lite <u>Gabriel:</u> Soul, Soul Mel, Twist, Twist Mel, Focus Melange Screen, Cura Screen <u>Kvadrat:</u> Hint</p>		<p>Price group 3: <u>Camira:</u> Blazer, Main Line Flax <u>Gabriel:</u> Step Melange Screen <u>Kvadrat:</u> Remix, Remix Screen, Floyd Scr.</p>		
	<p>Sound absorbing desk screen 1800x600 mm incl black fittings</p>	<p>60 97 81800-xxx</p>	<p>PG 1 570</p>	<p>PG 2 676</p>	<p>PG 3 775</p>	
	<p>Sound absorbing desk screen 1600x600 mm incl black fittings</p>	<p>60 97 81600-xxx</p>	<p>496</p>	<p>566</p>	<p>711</p>	
	<p>Sound absorbing desk screen 1400x600 mm incl black fittings</p>	<p>60 97 81400-xxx</p>	<p>478</p>	<p>552</p>	<p>658</p>	
	<p>Sound absorbing desk screen 1200x600 mm incl black fittings</p>	<p>60 97 81200-xxx</p>	<p>463</p>	<p>537</p>	<p>606</p>	

HORREDS WORK DESKS

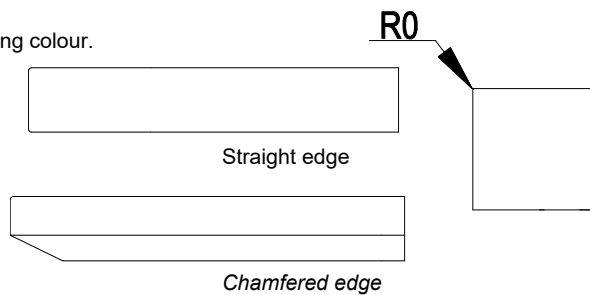


Here is a presentation of our work desks.

For information on desk materials and stands, see next page.

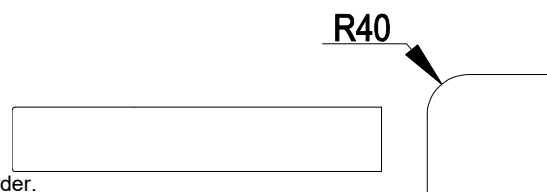
VX

- VX desk tops are made of 19 mm MDF with edging in matching colour.
- Corner radius 0 mm.
- Option: chamfered edge
- Option: cable entries
- Option: Horreds height adjustment control milled in desk top (touchpad).



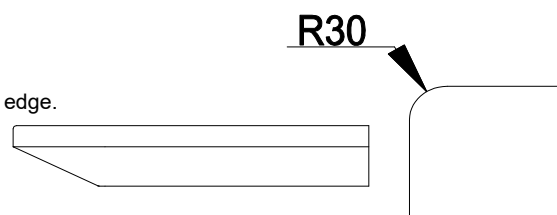
Henry Design: sandellsandberg

- Henry desk tops are made of 19 mm MDF with white plastic edge.
- Corner radius 40 mm.
- Cable holes with slot as standard unless otherwise stated in the order.
- Option: Horreds height adjustment control milled in desk top (touchpad).



Fri Design: Bror Boije

- Fri desk tops are made of 19 mm MDF with chamfered, clear coated edge.
- Corner radius 30 mm.
- Option: cable entries
- Option: Horreds height adjustment control milled in desk top (touchpad).



• Desk material:

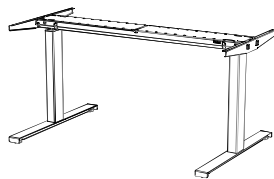
• High Pressure laminate:	Closest NCS:	Linoleum:	Closest NCS:	Veneer group 1:
White HPL (standard 0754)	S0502-Y	4132 Ash	5502-G	Birch (05)
Light grey HPL (opt. lam 0419)	S2002-Y	4154 Burgundy	7010-R10B	Oak (03)
Light grey HPL (opt. lam 1365)	S2005-R80B	4166 Charcoal	8502-B	Ash (06)
Medium grey HPL (opt. lam 1023)	S5500-N	4172 Mauve	7005-Y80R	Veneer group 2:
Anthracite HPL (opt. lam 1397)	S7500-N	4174 Conifer	8010-B90G	White pigmented oak (30)*
Black HPL (optional lam 2253)	S9000-N	4175 Pebble	3502-Y	White pigmented ash (10)*
		4176 Mushroom	2002-Y	Black stained ash (86)*
		4177 Vapour	2005-G10Y	Dark stained ash (76)*
		4179 Smokey Blue	7010-R90B	Burgundy stained ash (C8)*
		4184 Olive	5010-G50Y	Conifer stained ash (D3)*
				Smokey Blue st.ash (D4)*
				(*= <i>not Henry</i>)

• Electric stands:



VX11:

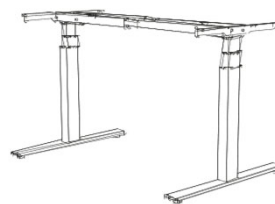
- Range 65 cm (desk height 61-126 cm)
- White (RAL9016) / Black (RAL9005) / Silver (RAL9006)
- Flexible frame 1156-1756 mm (black RAL9005)
- Lift capacity 160 kg, incl table top, in widened weight
- Only 0,1 w power consumption in standby mode
- PVC-free
- Anti-collision protection (DS1)
- Soft start/stop
- Integrated electronics
- Feet length 710 mm and 560 mm
- Fast click assembly



VX11

VX8:

- Range 65 cm (desk height 61-126 cm)
- White (RAL9016) / Black (RAL9005)
- Available in 8 optional Horreds colours, see page 164.
- Flexible frame (black RAL9005) *
- Lift capacity 140 kg, incl table top, in widened weight
- Only 0,1 w power consumption in standby mode
- PVC-free
- Anti-collision protection (Piezo)
- Soft start/stop
- Transformator with possibility of programming
- Feet length 700 mm and 550 mm
- Option: massive feet



VX8

• Stand with fixed height:

VX10:

- Fixed height 73 cm
- White (RAL9016) / Black (RAL9005) / Silver (RAL9006)
- Black frame (Black RAL 9005)
- Feet lengths 700 and 550 mm.

• For additional product information please see www.horreds.se

HORREDS WORK DESKS



E Desks within size 1600X800 mm.

Note: Table tops and frames are priced separately.

Table top (excluding stand)	art nr	White HPL (31)	Optional HPL (39)	Linoleum (88)	Veneer group 1	Veneer group 2
Series: Radius: Edge profile:						
VX (3416) 0 mm Straight / matching list	34xx16xxxxE	446	499	609	464	464
VX (3417) 0 mm Chamfered / matching list	34xx17xxxxE	558	611	721	576	576
Henry (80) 40 mm Straight/white pp-list, inc cable hole	80xxxxxE	477	532	691	502	
Fri (3513) 30 mm Chamfered / MDF	35xx13xxxxE	490	544	703	461	461
Option: Horreds touchpad	343707444	55	55	55	55	55
Option: Veneered edge on laminate		104	104			
Option: Veneered edge on linoleum: NB: Only oak/ash nature and white pigmented (not stained!)				104		

Cable holes: Henry has cable hole with slot as standard, for VX and Fri it is optional.

Stands (excl. table top)	Art nr	White (31)	Black (37)	Silver (38)	Horreds opt.colour (xx)
VX11 electric stand, range 65 cm, feet 71 cm	VX11xx657-x	549	549	549	
VX11 electric stand, range 65 cm, feet 56 cm	VX11xx655-x	549	549	549	
VX8 electric stand, range 65 cm	VX8xx2657F2	788	788		931
VX10 fixed height 73 cm	VX10xx2007F2	602	602	602	
Upcharge massive feet 700 mm to VX8+VX10		202	202		

	Rectangular (mm):	Drawing number:		
1600 - 1400 - 1200		VX	Henry	Fri
	1600x800	7025	8402	2068
	1400x800	7024	8419	2067
	1200x800	7023	8523	2066
1600 - 1400 - 700				
	1600x700	7063	8542	2153
	1400x700	7109	8421	2245
	1200x700	7183	8594	2846

HORREDS WORK DESKS

B Desks within size 2000X900 mm.

Note: Table tops and frames are priced separately.

Table top (excluding stand)	art nr	White HPL (31)	Optional HPL (39)	Linoleum (88)	Veneer group 1	Veneer group 2
Series: Radius: Edge profile:						
VX (3416) 0 mm Straight / matching list	34xx16xxxxB	482	592	702	488	488
VX (3417) 0 mm Chamfered / matching list	34xx17xxxxB	594	704	814	600	600
Henry (80) 40 mm Straight/white pp-list, inc cable hole	80xxxxxB	515	629	788	528	
Fri (3513) 30 mm Chamfered / MDF	35xx13xxxxB	528	642	801	487	487
<i>Option: Horreds touchpad</i>	343707444	55	55	55	55	55
<i>Option: Veneered edge on laminate</i>		104	104			
<i>Option: Veneered edge on linoleum: NB: Only oak/ash nature and white pigmented (not stained!)</i>				104		

Cable holes: Henry has cable hole with slot as standard, for VX and Fri it is optional.

Stands (excl. table top)	Art nr	White (31)	Black (37)	Silver (38)	Horreds opt.colour (xx)
VX11 electric stand, range 65cm Note: max desk length 1800 mm.	VX11xx657-x	549	549	549	
VX8 electric stand, range 65cm	VX8xx2657F2	788	788		931
VX10 fixed height 73 cm	VX10xx2007F2	602	602	602	
<i>Upcharge massive feet 700 mm to VX8+VX10</i>		202	202		

Drawing number:

	Rectangular (mm):	VX	Henry	Fri
	2000x900	7037	8403	2341
	2000x800	7027	8404	2069
	1800x900	7036	8405	2662
	1800x800	7026	8401	2028
	1600x900	7035	8408	2729
	Magbord (mm):			
	2000x900			2447
	1800x900			3149
	Magbord (mm):			
	2000x900			3701
	1800x900			3013
	1600x900			2980

HORREDS SKRIVBORD

C Desks within size 1200X600 mm.

Note: Table tops and frames are priced separately.

Table top (excluding stand)	art nr	White HPL (31)	Optional HPL (39)	Linoleum (88)	Veneer group 1	Veneer group 2
Series: Radius: Edge profile:						
VX (3416) 0 mm Straight / matching list	34xx16xxxxC	395	425	513	392	392
VX (3417) 0 mm Chamfered / matching list	34xx17xxxxC	507	537	625	504	504
Henry (80) 40 mm Straight/white pp-list, inc cable hole	80xxxxxC	426	559	594	430	
Fri (3513) 30 mm Chamfered / MDF	35xx13xxxxC	439	465	607	389	389
<i>Option: Horreds touchpad</i>	343707444	55	55	55	55	55
<i>Option: Veneered edge on laminate</i>		104	104			
<i>Option: Veneered edge on linoleum: NB: Only oak/ash nature and white pigmented (not stained!)</i>				104		

Cable holes: Henry has cable hole with slot as standard, for VX and Fri it is optional.

Stands (excl.table top)	Art nr	White (31)	Black (37)	Silver (38)	Horreds opt.colour (xx)
VX11 electric stand, range 65 cm	VX11xx655-x	549	549	549	
VX8 electric stand, range 65 cm	VX8xx2655F2	788	788		931
VX10 stand, fixed height 73 cm	VX10xx2005F2	602	602	602	

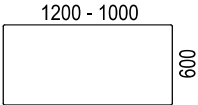



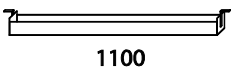
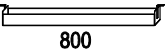


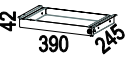
	Rectangular (mm):	Drawing number:		
		VX	Henry	Fri
	1200x600	7013	8513	2162
1000x600	7012	8567	2139	

Illustration	Description	Article number	Material	EUR					
CABLE ENTRIES & CABLE TRAYS FOR DESKS									
<ul style="list-style-type: none"> • Cable entries, diameter 80 mm, including lid. • For desks in series Fri and VX. • If other entry than our standard; please contact customer service for price. 									
Entry codes									
	Cable entry 80 mm, including lid in plastic	3931850	white	Y1	Y2	Y3	Y4	Y5	Y8
		3937850	black	32	32	32	38	38	38
	Lid only	573180	white	6					
		573780	black	6					
Power dot entries 80mm				Y1	Y2	Y3			
	Powerdot cable entry 80 mm with 1xpower and 4 Magic Holes	935-PD10	black	66	66	66			
		935-PD10W	white	66	66	66			
	Powerdot cable entry 80 mm. 1 power, 2 USB-C charger (2x30W), 1 magic hole ø8 mm).	935-PD17	black	190	190	190			
		935-PD17W	white	190	190	190			
Power dot entries 60mm				F1	F2	F3			
	Powerdot cable entry 60 mm 1 x power + 1 x USB-A charger	935-PM61	black	103	103	103			
		935-PM61W	white	103	103	103			
	Powerdot cable entry 60 mm 1 x power + 1 x USB-C PD charger	935-PM62	black	144	144	144			
		935-PM62W	white	144	144	144			
	Axessline cordless charger ø 60 mm. Qi-standard for smartphones	935-QI60B	black	176	176	176			
		935-QI60W	white	176	176	176			

Illustration	Description	Article number	Material	EUR		
	Power dot entries 51mm			Entry codes		
				D1	D2	D3
	Powerdot cable entry 51 mm. 1 power.	935-PM50 935-PM50W	Svart Vit	63 63	63 63	63 63
	Powerdot cable entry 51 mm. 2 USB-C PD charger	935-PM52 935-PM52W	Svart Vit	144 144	144 144	144 144
	Cable entries 30mm			J1	J2	J3
	Powerdot cable entry 30 mm 2 x USB-A charger	935-PM30 935-PM30W	Svart Vit	89 89	89 89	89 89
	Powerdot cable entry 30 mm 1 x USB-A and 1 USB-C charger	935-PM32 935-PM32W	Svart Vit	140 140	140 140	140 140
	Cable entry including lid 233x128 in Same material as desk top Note: no matching of veneer	57xx6253K		R1 center	R2 right	R3 left
	Cable entry, customized (without lid)	HAL1		115		
	Cable tray. Length 1100 mm. Adjustable 3 heights.. Minimum desk length: 1400 mm.	2937140 2931140 2938140	silver white silver	102 102 102		
	Cable tray. Length 800 mm. Adjustable 3 heights.	2937142 2931142 2938142	black white silver	102 102 102		
	Power socket, 3-ways, with bracket.	343707434	black	97		
	Power socket 3-ways, 3 m cable	936-E3V30B	black	27		
	Power socket 6-ways, 3 m cable	936-E6V30B	black	32		
	Cable pipe ø 20mm in braided textile. Length 1500 mm. With zipper.	3254000109 3254000101	black white	40 40		
	Cable pipe in textile. Length 1500 mm.	29371500 29311500	black white	119 119		
	Cable cover 1300 mm i tyg (Gabriel Runner 60999)	341300-600	black	87		

ACCESSORIES DESKS

• For additional product information: please see www.horreds.se

	Metallic pen drawer 390x245x42 mm,	4048	black	229
	Metallic pen drawer 390x245x42 mm, with lock.	4015-L	black	191

VX**VX8 & VX11 STANDS**

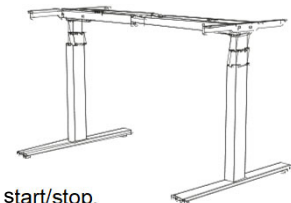
VX8 is the premium stand option, available in 10 colours and completely PVC-free.

Anti-collision, 60mm/s lifting speed and 140kg lifting capacity are standard.

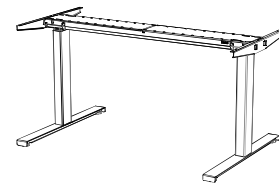
VX11 is a stand with easy assembly. The four parts of the concept are carefully designed to either click together or to be attached with a few screws. The beam is the heart of the system because the motor, electronics and wiring already are pre-assembled.

VX8 ELBORDSSTATIV

- Has only 0,1 w power consumption in standby mode and is completely PVC-free.
- Lift capacity 60mm/s is standard, 80mm/s is optional..
- Can be programmed in different elevation intervals, has piezo (anti-collision protection) and soft start/stop.
- Range 65 cm (table height 61-126 cm)
- Lifting capacity 140 kg, including table top, in widened weight.
- Premium design with leg profiles without holes / visible sliding pads.
- Complete stand with legs, feet, black flexible frame and hand control under the table.
- Optional: touchpad (hand control milled into desk top)
- Colours: White (RAL9016) and Black (RAL9005) as standard, with massive feet as option..
- Available in 8 Horreds optional colours, see page 164.
- Feet in two sizes; 55cm / 70cm.

**VX11 ELECTRICAL STAND**

- Has only 0,1 w power consumption in standby mode and is completely PVC-free.
- With anti-collision protection (DS1) and soft start/stop.
- Range 65 cm (table height 61-126 cm)
- Lifting capacity 160 kg, including table top, in widened weight.
- Complete stand with legs, feet, black flexible frame and hand control under the table.
- Optional: touchpad (hand control milled into desk top)
- Colours: White (RAL9016) / Black (RAL9005) / Silver (RAL 9006)
- Feet in two sizes; 56cm / 71cm.

**VX10 T-LEGS**

- Fixed height 73 cm.
- Complete stand with legs, feet, black frame.
- Colours: White (RAL9016) / Black (RAL9005) / Silver (RAL 9006)
- Feet in two sizes; 55cm / 70cm.

• For additional product information please see www.horreds.se

Description	Art.nr	EUR
<p>VX STANDS WITH T-LEGS</p> <p>VX11 with desk depth 800-900mm is delivered with feet 710mm, table depth 600-700mm with feet 560mm. VX8 with desk depth 800-900mm is delivered with feet 700mm, table depth 600-700mm with feet 550mm. VX10 with desk depth 800-900mm is delivered with feet 700mm, table depth 600-700mm with feet 550mm.</p> <p>Standard colours RAL VX10 / VX11: White 9016 (31), Black 9005 (37), Grey 9006 (38)</p> <p>Standard colours RAL VX8: White 9016 (31), Black 9005 (37)</p> <p>Optional colours RAL VX8: 1019 Grey beige (3H), 1024 Ochre yellow (3G), 3007 Black red (3D), 5008 Grey blue (3C) 6009 Fir green (3L), 6013 Reed green (3K), 7039 Quartz grey (3J), 7044 Silk grey (3A)</p>		

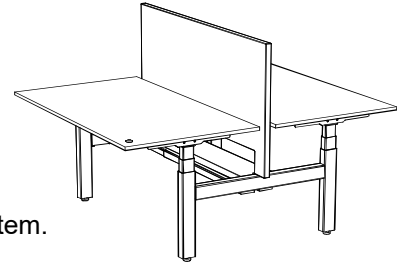
VX11	Article number	White (31) Black (37) Grey (38)
T-stand with flexible frame 1156-1756 mm, range 650mm		
VX11 to desk length 1200-1800mm and depth 800-900mm, feet 710mm	VX11xx657-x	549
VX11 till desk length 1200-1800mm and depth 600-700mm, feet 560mm	VX11xx655-x	549
Disassembly tool VX11	SA1023W1241	19

VX8	Article number	White (31) Black (37)	Horreds optional colours
T-stand with flexible frame (choose F1, F2, F3) feet 700mm / 550mm			
VX8, range 650mm, for desk length 1100-1600mm	VX8xx265xF1	788	931
VX8, range 650mm, for desk length 1300-1700mm	VX8xx265xF2	788	931
VX8, range 650mm, for desk length 1600-2200mm	VX8xx265xF3	788	931
Option: High Speed 80mm/s lifting capacity		17	17
Option: Massive feet 700mm (white/black)	52xx02640	202	

VX10	Article number	White (31) Black (37) Grey (38)
T-bensstativ med fast höjd, flexibel sarg (välj F1, F2, F3) fot 700mm / 550mm		
VX10, desk height 730mm, for table lengths 1100-1600mm	VX8xx265xF1	602
VX10, desk height 730mm, for table lengths 1300-1700mm	VX8xx265xF2	602
VX10, desk height 730mm, for table lengths 1600-2200mm	VX10xx200xF3	602
Option: Massive feet 700mm (white/black only)	52xx02640	202

VX DUO

D DOUBLE STAND

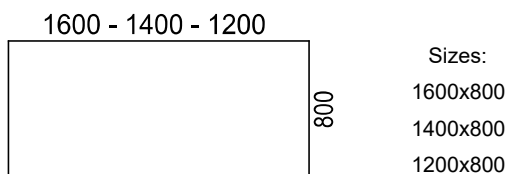
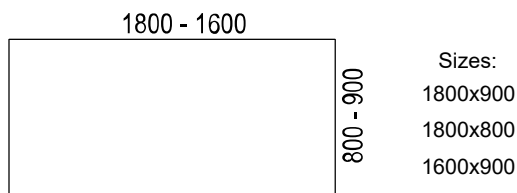


Complete package containing 2 pcs VX table top and 1 Duo stand.
Duo stand with Piezo anti-collision, High Speed (80mm/s), PVC-free system.

	Colour	Article number	White HPL (31)	Optional HPL (39)	Linoleum (88)	Veneer group 1	Veneer group 2
1800x900, 1800x800, 1600x900mm: 2 x table tops and 1 x Duo stand. (60-125 cm)	White	3431DUOxxx	2 805	3 035	3 245	2 816	2 816
	Black	3437DUOxxx	2 805	3 035	3 245	2 816	2 816
1600x800, 1400x800, 1200x800mm: 2 x table tops and 1 x Duo stand. (60-125 cm)	White	3431DUOxxx	2 733	2 838	3 058	2 769	2 769
	Black	3437DUOxxx	2 733	2 838	3 058	2 769	2 769

TILLVAL:

Flexible cable tray with lid	White	34311870	178				
Flexible cable tray with lid	Black	34371870	178				
Option: Horreds touchpad. Price per desk	Black	343707444	63				
Option: Veneered edge on laminate			104				
Option: Veneered edge on linoleum*			104				*only clear coated and white pigmented oak/ash
Cable entries and accessories		See page 39					
Desk screens, table-mounted		See page 45					
Desk screen mounted in the stand		See next page					



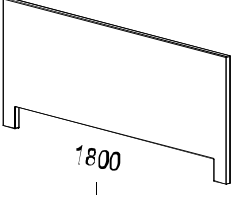
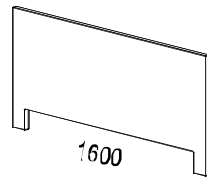
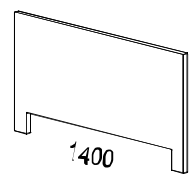
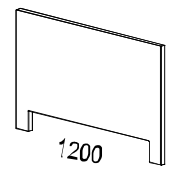
VX DUO DESK SCREENS IN FABRIC • For mounting in VX Duo stand. • Thickness approx.ca 35 mm, of which 30mm sound absorbent. • Fixed height 12cm above floor. • Brackets are ordered separatley. Choose white or black. • Don't forget to enter the colour code; see respectively fabric supplier's website.				
Price group 1: Camira: Cara, Carlow Gabriel: Event Screen, Hush	Price group 2: Camira: Blazer Lite Gabriel: Soul, Soul Mel., Twist, Twist Mel. Focus Melange Screen, Cura Screen Kvadrat: Hint Screen	Price group 3: Camira: Blazer, Main Line Flax Gabriel: Step Melange Screen Kvadrat: Remix, Remix Screen, Floyd Screen		
	Sound absorbing desk screen Lenght 1800 mm, exklusive beslag Brackets	34 97 09440 34 xx 09441	PG 1 PG 2 PG 3 white/black	332 404 470 34
	Sound absorbing desk screen Lenght 1600 mm, exklusive beslag Brackets	34 97 09439 34 xx 09441	PG 1 PG 2 PG 3 white/black	301 361 432 34
	Sound absorbing desk screen Lenght 184 mm, exklusive beslag Brackets	34 97 09438 34 xx 09441	PG 1 PG 2 PG 3 white/black	279 332 397 34
	Sound absorbing desk screen Lenght 1200 mm, exklusive beslag Brackets	34 97 09437 34 xx 09441	PG 1 PG 2 PG 3 white/black	265 314 364 34



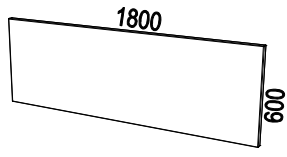
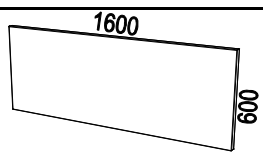
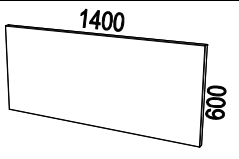
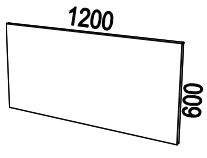
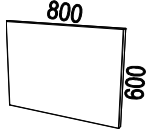
Illustration	Description	Article number	EUR		
VX					
	<p>VX sound absorbing desk screen</p> <ul style="list-style-type: none"> • Height 600 mm (of which 500 mm over desk). • Two different corner edges: radius 0 and radius 50. • Thickness 35 mm, of which 30 mm sound absorber • Specification sound absorbent: <ul style="list-style-type: none"> - 30 mm polyester wadding (1000g/m2) - 100% polyester, up to 80% regenerated fibres - Certified according to Ökotex, class 1. • Max weight capacity 25 kg. • Fittings to be ordered separately. • Also suitable for desks Henry and Fri. • For fabric codes: please see the supplier's website • For additional product information, please see www.horreds.se 				
<p>Price group 1:</p> <p><u>Camira:</u> Cara, Carlow</p> <p><u>Gabriel:</u> Event Screen, Hush</p>		<p>Price group 2:</p> <p><u>Camira:</u> Blazer Lite</p> <p><u>Gabriel:</u> Soul, Soul Mel, Twist, Twist Mel, Focus Melange Screen, Cura Screen</p> <p><u>Kvadrat:</u> Hint</p>		<p>Price group 3:</p> <p><u>Camira:</u> Blazer, Main Line Flax</p> <p><u>Gabriel:</u> Step Melange Screen</p> <p><u>Kvadrat:</u> Remix, Remix Screen, Floyd Scr.</p>	
			PG 1	PG 2	PG 3
	<p>Sound absorbing desk screen, straight corners. Lenght 1800 mm, exkl brackets</p> <p>Brackets, 4-pcs, black</p>	<p>34 97 81800-x</p> <p>34 37 06794-4</p>	380	459	526
	<p>Sound absorbing desk screen, straight corners. Lenght 1600 mm, exkl brackets</p> <p>Brackets, 4-pcs, black</p>	<p>34 97 81600-x</p> <p>34 37 06794-4</p>	320	374	471
	<p>Sound absorbing desk screen, straight corners. Lenght 1400 mm, exkl brackets</p> <p>Brackets, 4-pcs, black</p>	<p>34 97 81400-x</p> <p>34 37 06794-4</p>	309	364	434
	<p>Sound absorbing desk screen, straight corners. Lenght 1200 mm, exkl brackets</p> <p>Brackets, 3-pcs, black</p>	<p>34 97 81200-x</p> <p>34 37 06794-3</p>	299	353	400
	<p>Sound absorbing desk screen, straight corners. Lenght 800 mm, exkl brackets</p> <p>Brackets, 2-pcs, black</p>	<p>34 97 08354-x</p> <p>34 37 06780</p>	200	237	268

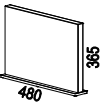
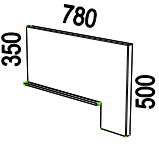

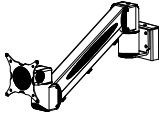

Illustration	Description	Article number	EUR		
			PG 1	PG 2	PG 3
	Sound absorbing desk screen, 480x365x35 mm. Incl foot in laquered steel. Choose colour of foot: white or black.	34 xx 03374-x	292	310	338
	Sound absorbing desk screen, 780x365x35 mm. Incl foot in laquered steel. Choose colour of foot: white or black.	34 xx 06360-x	362	398	434
Tillbehör till VX bordsskärmar					
			Material	EUR	
	Accessory strip in extruded aluminum. Can be attached to the table screen or to the wall.				
	Freewall 1750 mm	670 175	Silver	175	
		670 175-1	Vit	175	
	Freewall 1550 mm	670 155	Silver	160	
		670 155-1	Vit	160	
	Freewall 1350 mm	670 135	Silver	141	
		670 135-1	Vit	141	
	Monitor arm D-Zine Toolbar 3 (1,5-8,5 kg) To be attached in Freewall. VESA 75 och 100.	611 325 611 325-1	Silver Vit	403 403	
Tillbehör till VX fristående sidoskärm					
	Pennfack till fristående sidoskärm	34 31 03357	Vit	68	
		34 37 03357	Svart	68	


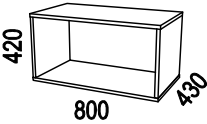
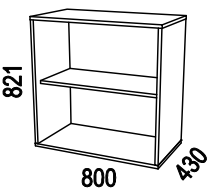
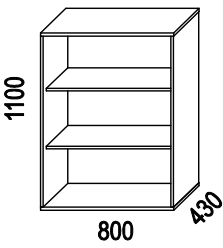
Illustration	Description	Article number	Material	EUR
<p style="text-align: center;">STORAGE BASIC UNITS</p> <div style="text-align: right;">  </div> <ul style="list-style-type: none"> • Basic unit in direct laminated or veneered particle board • White direct laminate = closest NCS S0300-N • Stationary shelves • For additional product information; please see www.horreds.se <p><u>Veneer group 1:</u> Birch (05), Oak (03), Ash (06).</p> <p><u>Veneer group 2:</u> White pigmented Oak (30), White pigmented Ash (10), Black stained Ash (86), Dark stained Ash (76).</p> <p>Note! Price is for basic unit only</p> <ul style="list-style-type: none"> • Base to be ordered separately. • Sliding doors to be ordered separately. 				
WIDTH 800 MM:				
	<p>Basic unit 800x420x430 mm. 1xA4-height prepared for sliding doors.</p> <p>As above but not prepared for sliding doors</p>	<p>57 31 71310</p> <p>57 xx 71310</p> <p>57 xx 71310</p> <p>57 31 71300</p> <p>57 xx 71300</p> <p>57 xx 71300</p>	<p>White direct lam.</p> <p>Veneer group 1</p> <p>Veneer group 2</p> <p>White direct lam.</p> <p>Veneer group 1</p> <p>Veneer group 2</p>	<p>427</p> <p>662</p> <p>662</p> <p>427</p> <p>662</p> <p>662</p>
	<p>Basic unit 800x821x430 mm. 2xA4-height prepared for sliding doors.</p> <p>As above but not prepared for sliding doors</p>	<p>57 31 72310</p> <p>57 xx 72310</p> <p>57 xx 72310</p> <p>57 31 72300</p> <p>57 xx 72300</p> <p>57 xx 72300</p>	<p>White direct lam.</p> <p>Veneer group 1</p> <p>Veneer group 2</p> <p>White direct lam.</p> <p>Veneer group 1</p> <p>Veneer group 2</p>	<p>467</p> <p>863</p> <p>863</p> <p>467</p> <p>863</p> <p>863</p>
	<p>Basic unit 800x1100x430 mm. 3xA4-height prepared for sliding doors.</p> <p>As above but not prepared for sliding doors</p>	<p>57 31 73310</p> <p>57 xx 73310</p> <p>57 xx 73310</p> <p>57 31 73300</p> <p>57 xx 73300</p> <p>57 xx 73300</p>	<p>White direct lam.</p> <p>Veneer group 1</p> <p>Veneer group 2</p> <p>White direct lam.</p> <p>Veneer group 1</p> <p>Veneer group 2</p>	<p>596</p> <p>1 181</p> <p>1 181</p> <p>596</p> <p>1 181</p> <p>1 181</p>

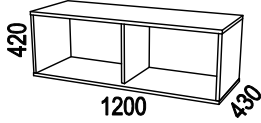
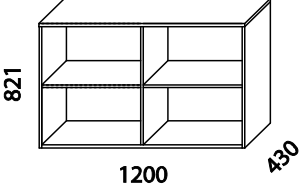
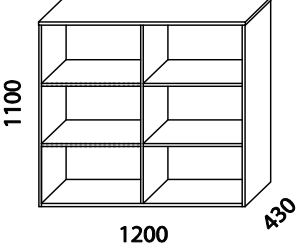
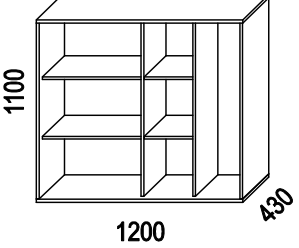
Illustration	Description	Article number	Material	EUR
WIDTH 1200 MM:				
	Basic unit 1200x420x430 mm. 1xA4-height prepared for sliding doors.	57 31 71510	White direct lam.	484
		57 xx 71510	Veneer group 1	877
		57 xx 71510	Veneer group 2	877
	As above but not prepared for sliding doors	57 31 71500	White direct lam.	484
		57 xx 71500	Veneer group 1	877
		57 xx 71500	Veneer group 2	877
	Basic unit 1200x821x430 mm. 2xA4-height prepared for sliding doors.	57 31 72510	White direct lam.	563
		57 xx 72510	Veneer group 1	1 159
		57 xx 72510	Veneer group 2	1 159
	As above but not prepared for sliding doors	57 31 72500	White direct lam.	563
		57 xx 72500	Veneer group 1	1 159
		57 xx 72500	Veneer group 2	1 159
	Basic unit 1200x1100x430 mm. 3xA4-height prepared for sliding doors.	57 31 73510	White direct lam.	643
		57 xx 73510	Veneer group 1	1 223
		57 xx 73510	Veneer group 2	1 223
	As above but not prepared for sliding doors	57 31 73500	White direct lam.	643
		57 xx 73500	Veneer group 1	1 223
		57 xx 73500	Veneer group 2	1 223
	Basic unit 1200x1100x430 mm with wardrobe compartment. 3xA4-height, prepared for sliding doors.	57 31 73512	White direct lam.	866
		57 xx 73512	Veneer group 1	1 531
		57 xx 73512	Veneer group 2	1 531

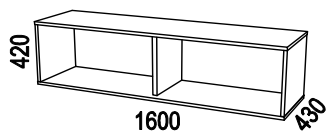
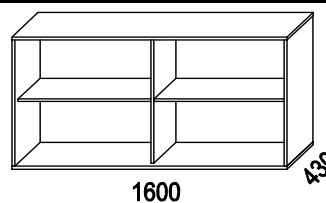
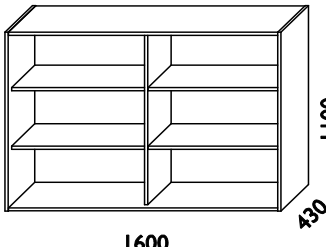
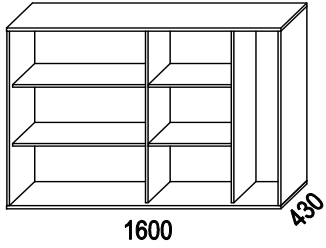
Illustration	Description	Article number	Material	EUR
WIDTH 1600 MM:				
	Basic unit 1600x420x430 mm. 1xA4-height, prepared for sliding doors.	57 31 71710	White direct lam.	616
		57 xx 71710	Veneer group 1	1 035
		57 xx 71710	Veneer group 2	1 035
	As above but not prepared for sliding doors	57 31 71700	White direct lam.	616
		57 xx 71700	Veneer group 1	1 035
		57 xx 71700	Veneer group 2	1 035
	Basic unit 1600x821x430 mm. 2xA4-height, prepared for sliding doors.	57 31 72710	White direct lam.	686
		57 xx 72710	Veneer group 1	1 395
		57 xx 72710	Veneer group 2	1 395
	As above but not prepared for sliding doors	57 31 72700	White direct lam.	686
		57 xx 72700	Veneer group 1	1 395
		57 xx 72700	Veneer group 2	1 395
	Basic unit 1600x1100x430 mm. 3xA4-height, prepared for sliding doors.	57 31 73710	White direct lam.	858
		57 xx 73710	Veneer group 1	1 511
		57 xx 73710	Veneer group 2	1 511
	As above but not prepared for sliding doors	57 31 73700	White direct lam.	858
		57 xx 73700	Veneer group 1	1 511
		57 xx 73700	Veneer group 2	1 511
	Basic unit 1600x1100x430 mm with wardrobe compartment. 3xA4-height, prepared for sliding doors.	57 31 73712	Vit direktlaminat	1 016
		57 xx 73712	Faner grupp 1	1 866
		57 xx 73712	Faner grupp 2	1 866


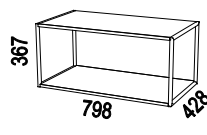
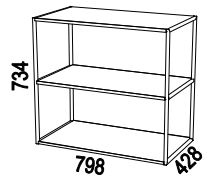
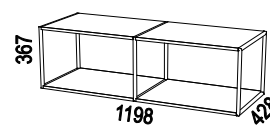
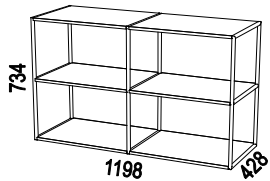
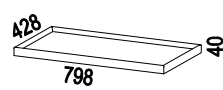
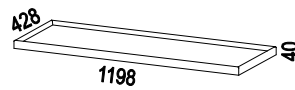
Illustration	Description	Article number	Material	EUR
Biblio Design: Anderssen & Voll				
 MÖBELFAKTA				
BIBLIO EXTENSION UNITS <ul style="list-style-type: none"> • Metallic extension unit I: white (RAL 9016 str) and black (RAL 9005 str) • Shelves: <ul style="list-style-type: none"> -White lacquer NCS S0300-N -Veneer group 1: Oak (03), Ash (06) - Veneer group 2: Black ash (86), Dark ash (76), White oak (30), White ash (10) • For additional product information see www.horreds.se 				
	Extension unit 798x367x428 mm	64 xx31 -0801	White shelves	533
	in white or black metal with shelves	64 xxxx -0801	Veneer gr 1 shelves	669
	in white lacquer or veneer	64 xxxx -0801	Veneer gr 2 shelves	669
	Extension unit 798x734x428 mm	64 xx31 -0802	White shelves	651
	in white or black metal with shelves	64 xxxx -0802	Veneer gr 1 shelves	866
	in white lacquer or veneer	64 xxxx -0802	Veneer gr 2 shelves	866
	Extension unit 1198x367x428 mm	64 xx31 -1201	White shelves	764
	in white or black metal with shelves	64 xxxx -1201	Veneer gr 1 shelves	1 028
	in white lacquer or veneer	64 xxxx -1201	Veneer gr 2 shelves	1 028
	Extension unit 1198x734x428 mm	64 xx31 -1202	White shelves	1 093
	in white or black metal with shelves	64 xxxx -1202	Veneer gr 1 shelves	1 459
	in white lacquer or veneer	64 xxxx -1202	Veneer gr 2 shelves	1 459
BIBLIO TRAYS <ul style="list-style-type: none"> • Tray in veneer with massive edges. -Veneer group 1: Oak (03), Ash (06) - Veneer group 2: Black ash (86), Dark ash (76), White oak (30), White ash (10) • For additional product information see www.horreds.se 				
	Tray 798x428x40 mm	64 xx 07525-080	Veneer group 1	474
			Veneer group 2	474
	Tray 1198x428x40 mm	64 xx 07525-120	Veneer group 1	500
			Veneer group 2	500

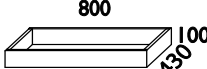
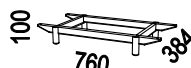
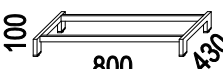

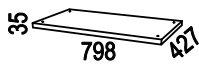
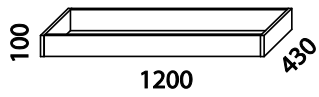
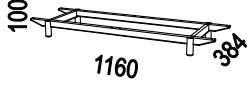
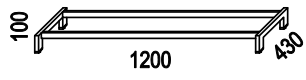

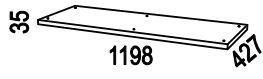
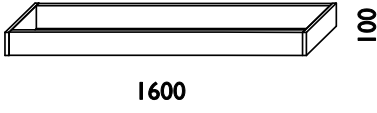
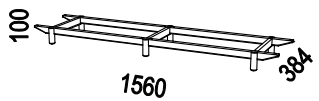
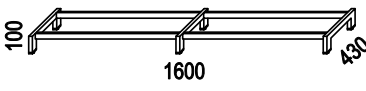

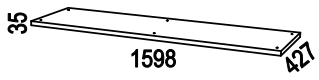
Illustration	Description	Article number	Material	EUR
<p>BASES</p> <p>• For basic units with depth 430 mm. • For additional product information; please see www.horreds.se</p> <p>MÖBELFAKTA</p> <p><u>Veneer group 1:</u> Birch (05) Oak (03) Ash (06)</p> <p><u>Veneer group 2:</u> White pigmented Oak (30) White pigmented Ash (10) Black stained Ash (86) Dark stained Ash (76)</p>				
WIDTH 800 MM:				
	Base 800x100x430 mm	57 31 70310 57 xx 70310 57 xx 70310	White dir.lam. Veneer group 1 Veneer group 2	119 137 137
	Leg base, solid wood, height 100 mm.	57 03 70340 57 06 70340 57 xx 70340	Oak Ash Veneer group 2	315 315 315
	Leg base 800x100x430 mm, steel	57 31 70330 57 37 70330	White Black	144 144
	Castors. Height 100 mm. For 800 mm wide storage (4 castors of which 2 lockable)	39 08 28	Grey/zink	66
	Base plate with small adjustable feet, 798x35x427 mm	57 31 70381 57 xx 70381 57 xx 70381	White dir.lam. Veneer group 1 Veneer group 2	63 96 96
	Clamping knobs (4 pieces)	57 00 04-19		23

Illustration	Description	Article number	Material	EUR
WIDTH 1200 MM:				
	Base 1200x100x430 mm	57 31 70510 57 xx 70510 57 xx 70510	White dir.lam. Veneer group 1 Veneer group 2	130 168 168
	Leg base, solid wood, height 100 mm.	57 03 70540 57 06 70540 57 xx 70540	Oak Ash Veneer group 2	377 377 377
	Leg base 1200x100x430 mm, steel	57 31 70530 57 37 70530	White Blacke	161 161
	Castors. Height 100 mm. to 1600 mm wide storage (5 castors of which 2 lockable)	39 08 28-1	Grey/zink	84
	Base plate with small adjustable feet, 1198x35x427 mm	57 31 70581 57 xx 70581 57 xx 70581	White dir.lam. Veneer group 1 Veneer group 2	92 109 109
	Clamping knobs (6 pieces)	57 00 06-19		28
WIDTH 1600 MM:				
	Base 1600x100x430 mm	57 31 70710 57 xx 70710 57 xx 70710	White dir.lam. Veneer group 1 Veneer group 2	136 211 211
	Leg base, solid wood, height 100 mm.	57 03 70740 57 06 70740 57 xx 70740	Oak Ash Veneer group 2	483 483 483
	Leg base 1600x100x430 mm, steel	57 31 70730 57 37 70730	White Black	187 187
	Castors. Height 100 mm. to 1600 mm wide storage (6 castors of which 3 lockable)	39 08 28-2	Grey/zink	103
	Base plate with small adjustable feet, 1598x35x427 mm	57 31 70781 57 xx 70781 57 xx 70781	White dir.lam. Veneer group 1 Veneer group 2	99 121 121
	Clamping knobs (6 pieces)	57 00 06-19		28

Description	Article number	Material	EUR
-------------	----------------	----------	-----

Biblio Design: Anderssen & Voll

Biblio SLIDING DOORS



- Sliding doors in lacquered or veneered MDF
- Handles in veneered steel
- Fronts in optional NCS: delivery time 6 weeks.
- Including lock with 2 keys
- For additional product information please see www.horreds.se

Note! Price is for sliding doors only.

- Basic unit and base to be ordered separately.

Material:

Veneer group 1:

Oak (03)

Ash (06)

Veneer group 2:

White pigmented Oak (30)

White pigmented Ash (10)

Black stained Ash (86)

Dark stained Ash (76)

White laquer:

NCS S0300-N (31)

Handles:

03 Oak

06 Ash

30 White pigmented oak

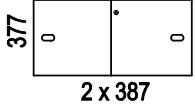
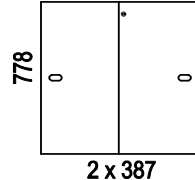
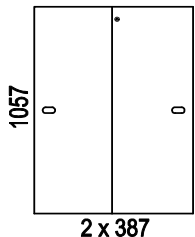
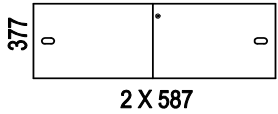
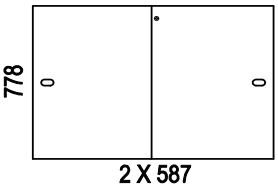
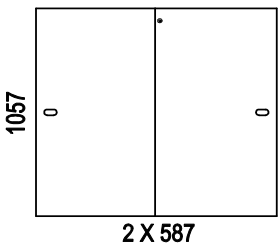
10 White pigmented ash

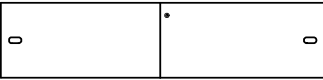
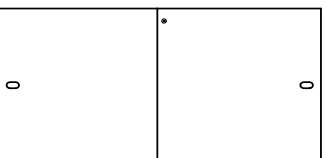
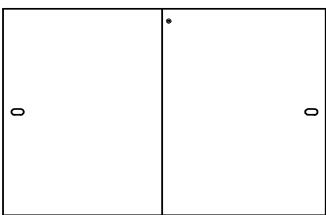
86 Black stained ash

76 Dark stained ash

31 White (RAL 9016)



Description	Article number	Material	EUR		
FOR STORAGE WIDTH 800 MM:					
 <p>377 0 2 x 387</p>	Biblio sliding doors 1xA4-height. Fit on basic unit 800x420x430 mm (art 71310)	64 31xx 713481A White direct laminate 64 xxxx 713481A Veneer group 1 64 xxxx 713481A Veneer group 2 64 99xx 713481A Optional NCS	538 634 634 773		
	 <p>778 0 2 x 387</p>	Biblio sliding doors 2xA4-height. Fit on basic unit 1200x821x430 mm (art 72510)	64 31xx 723481A White direct laminate 64 xxxx 723481A Veneer group 1 64 xxxx 723481A Veneer group 2 64 99xx 723481A Optional NCS	557 654 654 793	
		 <p>1057 0 2 x 387</p>	Biblio sliding doors 3xA4-height. Fit on basic unit 800x1100x430 mm (art 73310)	64 31xx 733481A White direct laminate 64 xxxx 733481A Veneer group 1 64 xxxx 733481A Veneer group 2 64 99xx 733481A Optional NCS	576 672 672 812
			FOR STORAGE WIDTH 1200 MM:		
 <p>377 0 2 X 587</p>			Biblio sliding doors 1xA4-height. Fit on basic unit 1200x420x430 mm (art 71510)	64 31xx 715481A White direct laminate 64 xxxx 715481A Veneer group 1 64 xxxx 715481A Veneer group 2 64 99xx 715481A Optional NCS	544 640 640 780
	 <p>778 0 2 X 587</p>		Biblio sliding doors 2xA4-height. fit on basic unit 1200x821x430 mm (art 72510)	64 31xx 725481A White direct laminate 64 xxxx 725481A Veneer group 1 64 xxxx 725481A Veneer group 2 64 99xx 725481A Optional NCS	583 679 679 818
		 <p>1057 0 2 X 587</p>	Biblio sliding doors 3xA4-height. Fit on basic unit 1200x1100x430 mm (art 73510 och 73512)	64 31xx 735481A White direct laminate 64 xxxx 735481A Veneer group 1 64 xxxx 735481A Veneer group 2 64 99xx 735481A Optional NCS	608 704 704 844

Description	Article number	Material	EUR
FOR STORAGE WIDTH 1600 MM:			
<p>377</p>  <p style="text-align: center;">2 X 791</p>	<p>Biblio sliding doors 1xA4-height. Fit on basic unit 1600x420x430 mm (art 71710)</p>	<p>64 31xx 717481A 64 xxxx 717481A 64 xxxx 717481A 64 99xx 717481A</p>	<p>White direct laminate 576 Veneer group 1 672 Veneer group 2 672 Optional NCS 812</p>
<p>778</p>  <p style="text-align: center;">2 X 791</p>	<p>Biblio sliding doors 2xA4-height. Fit on basic unit 1600x821x430 mm (art 72710)</p>	<p>64 31xx 727481A 64 xxxx 727481A 64 xxxx 727481A 64 99xx 727481A</p>	<p>White direct laminate 621 Veneer group 1 791 Veneer group 2 791 Optional NCS 857</p>
<p>1057</p>  <p style="text-align: center;">2 X 791</p>	<p>Biblio sliding doors 3xA4-height. Fit on basic unit 1600x1100x430 mm (art 73710 och 73712)</p>	<p>64 31xx 737481A 64 xxxx 737481A 64 xxxx 737481A 64 99xx 737481A</p>	<p>White direct laminate 669 Veneer group 1 826 Veneer group 2 826 Optional NCS 905</p>

Description	Article number	Material	EUR
-------------	----------------	----------	-----

Nomono Design: Fredrik Mattson

Nomono SLIDING DOORS



- Sliding doors in lacquered or veneered MDF
- Handles in lacquered steel sheet
- Fronts in optional NCS: delivery time 6 weeks.
- Including lock with 2 keys
- For additional product information please see www.horreds.se

Note! Price is for sliding doors only.

- Basic unit and base to be ordered separately.

Material:

Veneer group 1:

- Birch (05)
- Oak (03)
- Ash (06)

Veneer group 2:

- White pigmented Oak (30)
- White pigmented Ash (10)
- Black stained Ash (86)
- Dark stained Ash (76)

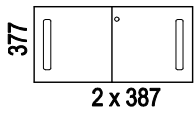
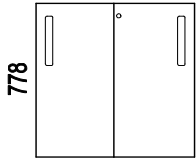
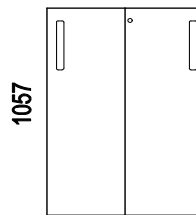
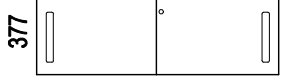
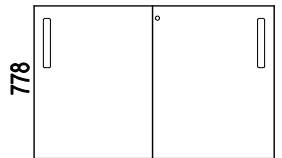
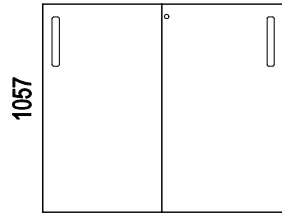
White laquer:

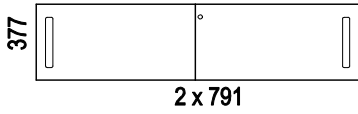
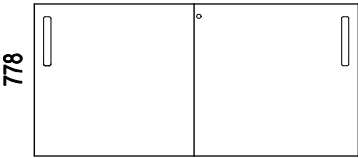
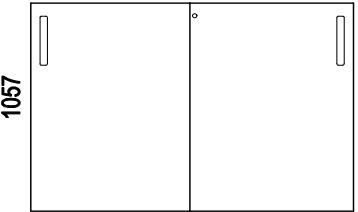
- NCS S0300-N (31)

Colour handles / Closest NCS

- 31** White S0300-N
- 37** Black S9000-N
- 32** Yellow S1070-Y
- 36** Green S2570-G30Y
- 33** Red S1580-Y80R
- 35** Turq.Blue S540-B30G
- 42** Orange S1080-Y50R
- xx** *Elmosoft Light Brown 54035
* additional cost € 70



Description	Article number	Material	EUR
FOR STORAGE WIDTH 800 MM:			
 <p>377 2 x 387</p>	Nomono sliding doors 1xA4-height. Fit on basic unit 800x420x430 mm (art 71310)	53 31xx 713381A White laquer	508
		53 xxxx 713381A Veneer group 1	603
		53 xxxx 713381A Veneer group 2	603
		53 99xx 713381A Optional NCS	740
 <p>778 2 x 387</p>	Nomono sliding doors 2xA4-height. Fit on basic unit 800x821x430 mm (art 72510)	53 31xx 723381A White laquer	528
		53 xxxx 723381A Veneer group 1	622
		53 xxxx 723381A Veneer group 2	622
		53 99xx 723381A Optional NCS	759
 <p>1057 2 x 387</p>	Nomono sliding doors 3xA4-height. Fit on basic unit 800x1100x430 mm (art 73310)	53 31xx 733381A White laquer	546
		53 xxxx 733381A Veneer group 1	641
		53 xxxx 733381A Veneer group 2	641
		53 99xx 733381A Optional NCS	778
FOR STORAGE WIDTH 1200 MM:			
 <p>377 2 x 587</p>	Nomono sliding doors 1xA4-height. Fit on basic unit 1200x420x430 mm (art 71510)	53 31xx 715381A White laquer	515
		53 xxxx 715381A Veneer group 1	609
		53 xxxx 715381A Veneer group 2	609
		53 99xx 715381A Optional NCS	746
 <p>778 2 x 587</p>	Nomono sliding doors 2xA4-height. fit on basic unit 1200x821x430 mm (art 72510)	53 31xx 725381A White laquer	553
		53 xxxx 725381A Veneer group 1	647
		53 xxxx 725381A Veneer group 2	647
		53 99xx 725381A Optional NCS	784
 <p>1057 2 x 587</p>	Nomono sliding doors 3xA4-height. Fit on basic unit 1200x1100x430 mm (art 73510 och 73512)	53 31xx 735381A White laquer	578
		53 xxxx 735381A Veneer group 1	672
		53 xxxx 735381A Veneer group 2	672
		53 99xx 735381A Optional NCS	809

Description	Article number	Material	EUR
FOR STORAGE WIDTH 1600 MM:			
 <p>377 2 x 791</p>	<p>Nomono sliding doors 1xA4-height. Fit on basic unit 1600x420x430 mm (art 71710)</p>	<p>53 31xx 717381A 53 xxxx 717381A 53 xxxx 717381A 53 99xx 717381A</p>	<p>White laquer 546 Veneer group 1 641 Veneer group 2 641 Optional NCS 778</p>
 <p>778 2 x 791</p>	<p>Nomono sliding doors 2xA4-height. Fit on basic unit 1600x821x430 mm (art 72710)</p>	<p>53 31xx 727381A 53 xxxx 727381A 53 xxxx 727381A 53 99xx 727381A</p>	<p>White laquer 591 Veneer group 1 757 Veneer group 2 757 Optional NCS 822</p>
 <p>1057 2 x 791</p>	<p>Nomono sliding doors 3xA4-height. Fit on basic unit 1600x1100x430 mm (art 73710 och 73712)</p>	<p>53 31xx 737381A 53 xxxx 737381A 53 xxxx 737381A 53 99xx 737381A</p>	<p>White laquer 638 Veneer group 1 791 Veneer group 2 872 Optional NCS 869</p>

Description	Article number	Material	EUR
-------------	----------------	----------	-----

VX

VX SLIDING DOORS



- Sliding doors in white direct laminated particle board or veneered MDF
- Steel handle
- Fronts in optional NCS (lacquered MDF): delivery time 6 weeks
- Including lock with 2 keys
- For additional product information please see www.horreds.se

Note! Price is for sliding doors only.

- Basic unit and base be ordered separately.

Material:

Veneer group 1:

Birch (05)

Oak (03)

Ash (06)

Veneer group 2:

White pigmented Oak (30)

White pigmented Ash (10)

Black stained Ash (86)

Dark stained Ash (76)

White direct laminate:

NCS S0300-N (31)

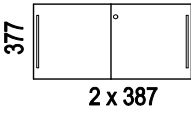
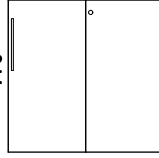
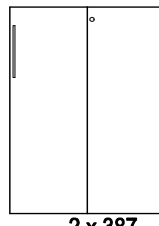
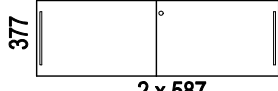
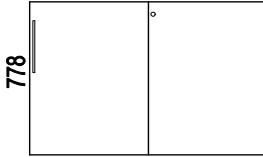
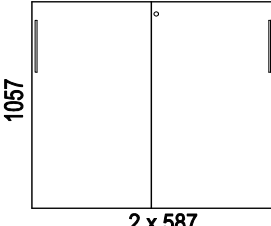
Colour handles

31 White

37 Black

17 Stainless steel look



Description	Article number	Material	EUR	
FOR STORAGE WIDTH 800 MM:				
 <p>377 2 x 387</p>	VX sliding doors 1xA4-height. Fit on basic unit 800x420x430 mm (art 71310)	34 31xx 713481A	White direct laminate	274
		34 xxxx 713481A	Veneer group 1	482
		34 xxxx 713481A	Veneer group 2	482
		34 99xx 713481A	Optional NCS	505
 <p>778 2 x 387</p>	VX sliding doors 2xA4-height. Fit on basic unit 800x821x430 mm (art 72510)	34 31xx 723481A	White direct laminate	289
		34 xxxx 723481A	Veneer group 1	500
		34 xxxx 723481A	Veneer group 2	500
		34 99xx 723481A	Optional NCS	521
 <p>1057 2 x 387</p>	VX sliding doors 3xA4-height. Fit on basic unit 800x1100x430 mm (art 73310)	34 31xx 733481A	White direct laminate	302
		34 xxxx 733481A	Veneer group 1	519
		34 xxxx 733481A	Veneer group 2	519
		34 99xx 733481A	Optional NCS	533
FOR STORAGE WIDTH 1200 MM:				
 <p>377 2 x 587</p>	VX sliding doors 1xA4-height. Fit on basic unit 1200x420x430 mm (art 71510)	34 31xx 715481A	White direct laminate	280
		34 xxxx 715481A	Veneer group 1	488
		34 xxxx 715481A	Veneer group 2	488
		34 99xx 715481A	Optional NCS	512
 <p>778 2 x 587</p>	VX sliding doors 2xA4-height. fit on basic unit 1200x821x430 mm (art 72510)	34 31xx 725481A	White direct laminate	305
		34 xxxx 725481A	Veneer group 1	524
		34 xxxx 725481A	Veneer group 2	524
		34 99xx 725481A	Optional NCS	535
 <p>1057 2 x 587</p>	VX sliding doors 3xA4-height. Fit on basic unit 1200x1100x430 mm (art 73510 och 73512)	34 31xx 735481A	White direct laminate	323
		34 xxxx 735481A	Veneer group 1	549
		34 xxxx 735481A	Veneer group 2	549
		34 99xx 735481A	Optional NCS	554

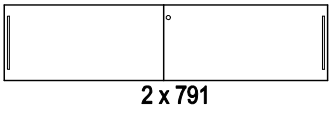
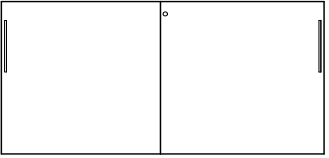
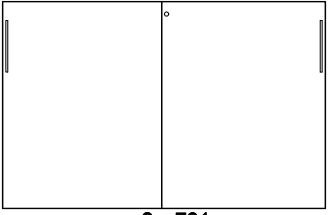
Description	Article number	Material	EUR	
FOR STORAGE WIDTH 1600 MM:				
	<p>VX sliding doors 1xA4-height. Fit on basic unit 1600x420x430 mm (art 71710)</p>	<p>34 31xx 717481A 34 717481A 34 717481A 34 717481A</p>	<p>White direct laminate Veneer group 1 Veneer group 2 Optional NCS</p>	<p>295 519 519 527</p>
	<p>VX sliding doors 2xA4-height. Fit on basic unit 1600x821x430 mm (art 72710)</p>	<p>34 31xx 727481A 34 xxxx 727481A 34 xxxx 727481A 34 99xx 727481A</p>	<p>White direct laminate Veneer group 1 Veneer group 2 Optional NCS</p>	<p>323 630 630 554</p>
	<p>VX sliding doors 3xA4-height. Fit on basic unit 1600x1100x430 mm (art 73710 och 73712)</p>	<p>34 31xx 737481A 34 xxxx 737481A 34 xxxx 737481A 34 99xx 737481A</p>	<p>White direct laminate Veneer group 1 Veneer group 2 Optional NCS</p>	<p>359 664 664 590</p>

Illustration	Description	Article number	Material	EUR
Siglo Design: Henrik Schulz				
	<p>Siglo I STORAGE</p> <ul style="list-style-type: none"> • Basic unit in direct laminated alt. veneered particle board • Doors in direct laminate alt. veneered MDF • Back in melamine • Works also as a room divider • Stationary shelves • Clamping knobs as standard. Wooden base as option • For additional product information; please see www.horreds.se <p><u>Material:</u></p> <p>Veneer group 1: Birch (05) Oak (03) Ash (06)</p> <p>Veneer group 2: Black stained Ash (86) Dark stained Ash (76) White pigmented Oak (30) White pigmented Ash (10)</p> <p>White direct laminate: Closest NCS: S0300-N</p> <p><u>Handles standard:</u></p> <p>31 White plastic 37 Black plastic</p> <p><u>Handles optional:</u></p> <p>16 Brass 17 Stainless</p> <p><u>Options:</u></p> <ul style="list-style-type: none"> • Handles in brass or stainless steel: additional fee € 269. • Doors in optional NCS: additional fee € 249. Delivery time 6 weeks. 			
WIDTH 800 MM:			Unit / doors	
	<p>Unit 800x420x430 mm (art 71310) including sliding doors (art 713081A) and clamping knobs (art 600004-19).</p>	<p>60 3131xx S1A1</p> <p>60 31xxxx S1A1</p> <p>60 31xxxx S1A1</p> <p>60 xx31xx S1A1</p> <p>60 xx31xx S1A1</p> <p>60 xxxxxx S1A1</p> <p>60 xxxxxx S1A1</p>	<p>White/white</p> <p>White/veneer gr 1</p> <p>White/veneer gr 2</p> <p>Veneer gr 1 / White</p> <p>Veneer gr 2 / White</p> <p>Veneer/veneer gr 1</p> <p>Veneer/veneer gr 2</p>	<p>785</p> <p>1 018</p> <p>1 018</p> <p>1 046</p> <p>1 046</p> <p>1 297</p> <p>1 297</p>
	<p>Unit 800x821x430 mm (art 72310) including sliding doors (art 723081A) and clamping knobs (art 600004-19).</p>	<p>60 3131xx S1A2</p> <p>60 31xxxx S1A2</p> <p>60 31xxxx S1A2</p> <p>60 xx31xx S1A2</p> <p>60 xx31xx S1A2</p> <p>60 xxxxxx S1A2</p> <p>60 xxxxxx S1A2</p>	<p>White/white</p> <p>White/veneer gr 1</p> <p>White/veneer gr 2</p> <p>Veneer gr 1 / White</p> <p>Veneer gr 2 / White</p> <p>Veneer/veneer gr 1</p> <p>Veneer/veneer gr 2</p>	<p>913</p> <p>1 149</p> <p>1 149</p> <p>1 275</p> <p>1 275</p> <p>1 530</p> <p>1 530</p>

Illustration	Description	Article number	Material	EUR
<p>1100 800 430 1057 2 x 387</p>	Unit 800x1100x430 mm (art 73310) including sliding doors (art 733081A) and clamping knobs (art 600004-19).	60 3131xx S1A3	White/white	1 009
		60 31xxxx S1A3	White/veneer gr 1	1 253
		60 31xxxx S1A3	White/veneer gr 2	1 253
		60 xx31xx S1A3	Veneer gr 1 / White	1 623
		60 xx31xx S1A3	Veneer gr 2 / White	1 623
		60 xxxxxx S1A3	Veneer/veneer gr 1	1 885
		60 xxxxxx S1A3	Veneer/veneer gr 2	1 885
<p>100 800 430</p>	Add. fee for base 800x100x430 mm instead of clamping knobs	60 31 70310	White direct lam.	117
		60 xx 70310	Veneer group 1	129
		60 xx 70310	Veneer group 2	129
WIDTH 1200 MM:				
<p>420 1200 430 377 2 x 587</p>	Unit 1200x420x430 mm (art 71510) including sliding doors (art 715081A) and clamping knobs (art 600006-19).	60 3131xx S1B1	White/white	891
		60 31xxxx S1B1	White/veneer gr 1	1 124
		60 31xxxx S1B1	White/veneer gr 2	1 124
		60 xx31xx S1B1	Veneer gr 1 / White	1 280
		60 xx31xx S1B1	Veneer gr 2 / White	1 280
		60 xxxxxx S1B1	Veneer/veneer gr 1	1 531
		60 xxxxxx S1B1	Veneer/veneer gr 2	1 531
<p>821 1200 430 778 2 x 587</p>	Unit 1200x821x430 mm (art 72510) including sliding doors (art 725081A) and clamping knobs (art 600006-19).	60 3131xx S1B2	White/white	1 090
		60 31xxxx S1B2	White/veneer gr 1	1 337
		60 31xxxx S1B2	White/veneer gr 2	1 337
		60 xx31xx S1B2	Veneer gr 1 / White	1 604
		60 xx31xx S1B2	Veneer gr 2 / White	1 604
		60 xxxxxx S1B2	Veneer/veneer gr 1	1 870
		60 xxxxxx S1B2	Veneer/veneer gr 2	1 870
<p>1100 1200 430 1057 2 x 587</p>	Unit 1200x1100x430 mm (art 73510) including sliding doors (art 735081A) and clamping knobs (art 600006-19).	60 3131xx S1B3	White/white	1 111
		60 31xxxx S1B3	White/veneer gr 1	1 371
		60 31xxxx S1B3	White/veneer gr 2	1 371
		60 xx31xx S1B3	Veneer gr 1 / White	1 687
		60 xx31xx S1B3	Veneer gr 2 / White	1 687
		60 xxxxxx S1B3	Veneer/veneer gr 1	1 967
		60 xxxxxx S1B3	Veneer/veneer gr 2	1 967

Illustration	Description	Article number	Material	EUR
	Unit 1200x1100x430 mm with wardrobe (art 73512) including sliding doors (art 735081A) and clamping knobs (art 600006-19).	60 3131xx S1BG	White/white	1 510
		60 31xxxx S1BG	White/veneer gr 1	1 770
		60 31xxxx S1BG	White/veneer gr 2	1 770
		60 xx31xx S1BG	Veneer gr 1 / White	2 009
		60 xx31xx S1BG	Veneer gr 2 / White	2 009
		60 xxxxxx S1BG	Veneer/veneer gr 1	2 290
		60 xxxxxx S1BG	Veneer/veneer gr 2	2 290
	Add. fee for base 1200x100x430 mm instead of clamping knobs	60 31 70510	White direct lam.	127
		60 xx 70510	Veneer group 1	157
		60 xx 70510	Veneer group 2	157
WIDTH 1600 MM:				
	Unit 1600x420x430 mm (art 71710) including sliding doors (art 717081A) and clamping knobs (art 600006-19).	60 3131xx S1C1	White/white	1 014
		60 31xxxx S1C1	White/veneer gr 1	1 264
		60 31xxxx S1C1	White/veneer gr 2	1 264
		60 xx31xx S1C1	Veneer gr 1 / White	1 463
		60 xx31xx S1C1	Veneer gr 2 / White	1 463
		60 xxxxxx S1C1	Veneer/veneer gr 1	1 732
		60 xxxxxx S1C1	Veneer/veneer gr 2	1 732
	Unit 1600x821x430 mm (art 72710) including sliding doors (art 727081A) and clamping knobs (art 600006-19).	60 3131xx S1C2	White/white	1 246
		60 31xxxx S1C2	White/veneer gr 1	1 502
		60 31xxxx S1C2	White/veneer gr 2	1 502
		60 xx31xx S1C2	Veneer gr 1 / White	1 871
		60 xx31xx S1C2	Veneer gr 2 / White	1 871
		60 xxxxxx S1C2	Veneer/veneer gr 1	2 147
		60 xxxxxx S1C2	Veneer/veneer gr 2	2 147

Illustration	Description	Article number	Material	EUR
<p>Unit 1600x1100x430 mm (art 73710) including sliding doors (art 737081A) and clamping knobs (art 600006-19).</p>	<p>Unit 1600x1100x430 mm (art 73710) including sliding doors (art 737081A) and clamping knobs (art 600006-19).</p>	60 3131xx S1C3	White/white	1 373
		60 31xxxx S1C3	White/veneer gr 1	1 715
		60 31xxxx S1C3	White/veneer gr 2	1 715
		60 xx31xx S1C3	Veneer gr 1 / White	2 040
		60 xx31xx S1C3	Veneer gr 2 / White	2 040
		60 xxxxxx S1C3	Veneer/veneer gr 1	2 407
		60 xxxxxx S1C3	Veneer/veneer gr 2	2 407
<p>Unit 1600x1100x430 mm with wardrobe (art 73712) including sliding doors (art 737081A) and clamping knobs (art 600006).</p>	<p>Unit 1600x1100x430 mm with wardrobe (art 73712) including sliding doors (art 737081A) and clamping knobs (art 600006).</p>	60 3131xx S1CG	White/white	1 615
		60 31xxxx S1CG	White/veneer gr 1	1 956
		60 31xxxx S1CG	White/veneer gr 2	1 956
		60 xx31xx S1CG	Veneer gr 1 / White	2 315
		60 xx31xx S1CG	Veneer gr 2 / White	2 315
		60 xxxxxx S1CG	Veneer/veneer gr 1	2 780
		60 xxxxxx S1CG	Veneer/veneer gr 2	2 780
<p>Add. fee for base 1600x100x430 mm instead of clamping knobs</p>	<p>Add. fee for base 1600x100x430 mm instead of clamping knobs</p>	60 31 70710	White direct lam.	134
		60 xx 70710	Veneer group 1	201
		60 xx 70710	Veneer group 2	201



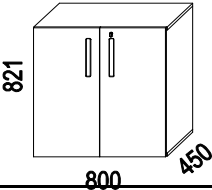
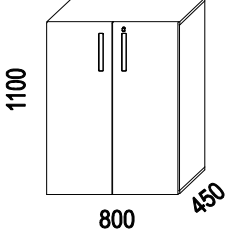
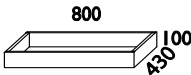
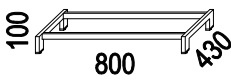
Illustration	Description	Article number	Material	EUR
Nomono Design: Fredrik Mattson				
<div style="display: flex; justify-content: space-between; align-items: flex-start;"> <div style="width: 25%;">  </div> <div style="width: 70%;"> <p>Nomono WITH HINGED DOORS</p> <ul style="list-style-type: none"> • Basic unit in direct laminated or veneered particleboard. • Hinged doors in lacquered or veneered MDF. Opening 110° • Including lock with 2 keys • Back in melamine • Stationary shelves • Fronts in optiona NCS: delivery time 6 weeks • Base not included, order separately • For additional product information please see www.horred.se <p>Material:</p> <p>Veneer group 1: Birch (05) Oak (03) Ash (06)</p> <p>Veneer group 2: White pigmented Oak (30) White pigmented Ash (10) Black stained Ash (86) Black stained Ash (76)</p> <p>White direct laminate and laquer: NCS S0300-N (31)</p> </div> <div style="width: 20%; text-align: right;">  </div> </div>				
<p style="text-align: right;">Colour handles / Closest NCS</p> <p>31 White S0300-N 37 Black S9000-N 32 Yellow S1070-Y 36 Green S2570-G30Y 33 Red S1580-Y80R 35 Turq.Blue S540-B30G 42 Orange S1080-Y50R xx * Elmosoft light brown 54035 * additional fee € 70.</p>				
	Storage 800x821x450 mm. 2 A4-height with hinged doors. <i>Upcharge for doors in optional NCS</i>	53 31xx 72340 53 xxxx 72340 53 xxxx 72340	White Veneer group 1 Veneer group 1	1 039 1 352 1 352 141
	Storage 800x1100x450 mm. 3 A4-height with hinged doors. <i>Upcharge for doors in optional NCS</i>	53 31xx 73340 53 xxxx 73340 53 xxxx 73340	White Veneer group 1 Veneer group 1	1 157 1 513 1 513 141
	Base 800x100x430 mm	57 31 70310 57 xxxx 70310 57 xxxx 70310	White Veneer group 1 Veneer group 1	119 137 137
	Leg base 800x100x430 mm, steel.	57 31 70330 57 37 70330	White Black	213 213



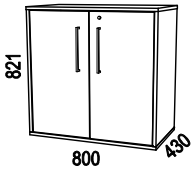
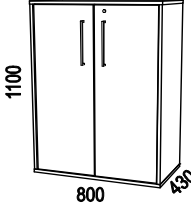
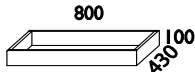
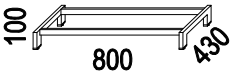




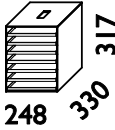
Illustration	Description	Article number	Material	EUR
VX				
VX WITH HINGED DOORS				
	<ul style="list-style-type: none"> • Basic unit in direct laminated or veneered particleboard. • Hinged doors in direct laminated particle board or veneered MDF. • Including lock with 2 keys. • Back in melamine • Stationary shelves • Base not included, order separately • For more product information; please see www.horreds.se 			
	<p>Material:</p> <p>Veneer group 1: birch (05), oak (03), ash (06)</p> <p>Veneer group 2: black ash (86), dark ash (76), white oak (30), white ash (10)</p> <p>White direct laminatet: closest NCS S0300-N (31)</p>	<p>Colour handles</p> <p>31 White</p> <p>37 Black</p> <p>17 Stainless steel look</p>		
	<p>Storage 800x821x430 mm.</p> <p>2 A4-height with hinged doors.</p> <p><i>Upcharge for doors in optional NCS</i></p>	<p>34 31xx 72330</p> <p>34 xxxx 72330</p> <p>34 xxxx 72330</p>	<p>White direct laminate</p> <p>Veneer group 1</p> <p>Veneer group 2</p>	<p>705</p> <p>1 236</p> <p>1 236</p> <p>231</p>
	<p>Storage 800x1100x430 mm.</p> <p>3 A4-height with hinged doors.</p> <p><i>Upcharge for doors in optional NCS</i></p>	<p>34 31xx 73330</p> <p>34 xxxx 73330</p> <p>34 xxxx 73330</p>	<p>White direct laminate</p> <p>Veneer group 1</p> <p>Veneer group 2</p>	<p>754</p> <p>1 327</p> <p>1 327</p> <p>231</p>
	<p>Base 800x100x430 mm</p>	<p>57 31 70310</p> <p>57 xx 70310</p> <p>57 xx 70310</p>	<p>White direct laminate</p> <p>Veneer group 1</p> <p>Veneer group 2</p>	<p>119</p> <p>137</p> <p>137</p>
	<p>Leg base 800x100x430 mm, steel.</p>	<p>57 31 70330</p> <p>57 37 70330</p>	<p>White</p> <p>Black</p>	<p>213</p> <p>213</p>
	<p>Castors. Height 100 mm.</p> <p>For 800 mm wide storage (4 castors of which 2 lockable).</p>	<p>39 08 28</p>	<p>Grey/zink</p>	<p>69</p>
	<p>Base plate with small adjustable feet</p> <p>798x35x427 mm</p>	<p>57 31 70381</p> <p>57 xx 70381</p> <p>57 xx 70381</p>	<p>White direct laminate</p> <p>Veneer group 1</p> <p>Veneer group 2</p>	<p>63</p> <p>96</p> <p>96</p>
	<p>Clamping knobs (4 pieces)</p>	<p>57 00 04</p>		<p>23</p>

Illustration	Description	Article number	Material	EUR
<p>ACCESSORIES TO STORAGE WITH DEPTH 43 CM</p> <p>• For more product information, see www.horreds.se</p>				
	<p>Insert in direct laminate with fronts in lacquer. 3 drawers. The top drawer is lockable.</p> <p><i>NB: does not fit VX width 80 cm with sliding doors.</i></p>	<p>57 31 076</p> <p>57 3199 076</p>	<p>White/white fronts</p> <p>White/opt.NCS fronts</p>	<p>353</p> <p>462</p>
	<p>Hanging file drawer, assembled on expansion racks.</p> <p>Fits in all units with slidings doors and in Nomono with hinged doors.</p>	<p>57 31 03160</p>	<p>White</p>	<p>177</p>
	<p>C4-letter stack. Including 7 letter trays.</p>	<p>50 047 134</p>	<p>Black</p>	<p>70</p>

VX

VX Personal Storage

- Basic unit in white chipboard with direct laminate coating.
- Doors in white direct laminate (chipboard) or lacquered and veneered (MDF).
- Movable shelves are ordered separately.
- Bases are ordererd separately
- Knobs/handles are ordered separately.
- Cover plates and top shelves as options.
- Must be anchored to the wall due to tipping risk.
- When ordering, specify whether doores should be right-hung (A, B) or left-hung (C, D). If nothing is specified, they are delivered right-hung.
- Doors with knob/handle with/without lock have soft-closed hinges, not push-open.
- Electronic locks: Mifare 13,56 MHz incl. battery.
- Battery replacement is recommended at 2-year intervals.
- Configurator to quickly see the price for your desired setup; see www.horreds.se/Productst/Storage/Personal Stoage.



Basic units: White direct laminate, closest NCS S0300-N (31).




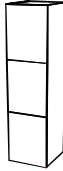



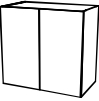
Doors white direct laminate: closest NCS S0300-N (31).


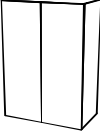
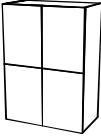
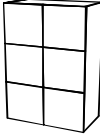

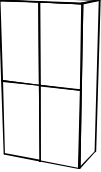
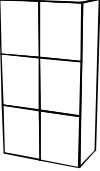
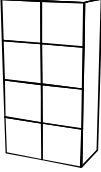
Doors Horreds optional NCS: see page 165





Doors customized optional NCS: Optional NCS (99).




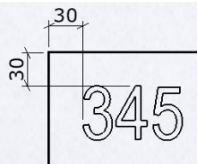

Doors veneer group 1: Oak (03), Ash (06), White oak (30), White Ash (10), Black Ash (86) Dark Ash (76), Stained ash, Burgundy (C8), Stained ash Conifer (D3), Stained ash Smokey Blue (D4).

		<u>Door model</u>	<u>Article number</u>	<u>White</u>	<u>Horreds NCS</u>	<u>Optional NCS</u>	<u>Veneer</u>
	Storage white direct laminate 432x432x477mm (BxHxD) incl 1 door.	Push-open, no lock	34 xx A00 A11D	24	26	29	32
		Electronic lock	34 xx zyy A11A	43	45	49	51
		Code lock	34 xx zyy A11B	30	32	35	38
		Cylinder lock	34 xx zyy A11C	28	30	34	36
	Storage white direct laminate 432x864x477mm (BxHxD) incl 1 door.	Push-open, no lock	34 xx A00 A21D	27	31	33	39
		Electronic lock	34 xx zyy A21A	46	50	53	59
		Code lock	34 xx zyy A21B	33	37	40	46
		Cylinder lock	34 xx zyy A21C	31	35	38	44
	Storage white direct laminate 432x864x477mm (BxHxD) incl 2 doors and 1 fixed shelf.	Push-open, no lock	34 xx A00 A22D	35	39	46	51
		Electronic lock	34 xx zyy A22A	74	78	85	90
		Code lock	34 xx zyy A22B	48	52	59	64
		Cylinder lock	34 xx zyy A22C	45	48	55	61
	Storage white direct laminate 432x1296x477mm (BxHxD) incl 1 dörr.	Push-open, no lock	34 xx A00 A31D	36	42	45	56
		Electronic lock	34 xx zyy A31A	55	61	65	76
		Code lock	34 xx zyy A31B	42	48	52	63
		Cylinder lock	34 xx zyy A31C	40	46	50	61
	Storage white direct laminate 432x1296x477mm (BxHxD) incl 2 doors and 1 fixed shelf.	Push-open, no lock	34 xx A00 A32D	40	46	52	65
		Electronic lock	34 xx zyy A32A	79	85	91	104
		Code lock	34 xx zyy A32B	53	59	65	77
		Cylinder lock	34 xx zyy A32C	50	56	62	74
	Storage white direct laminate 432x1296x477mm (BxHxD) incl 3 doors and 2 fixed shelves.	Push-open, no lock	34 xx A00 A33D	47	53	63	71
		Electronic lock	34 xx zyy A33A	105	111	122	130
		Code lock	34 xx zyy A33B	66	72	82	91
		Cylinder lock	34 xx zyy A33C	61	67	77	85

		<u>Door model</u>	<u>Article number</u>	<u>White</u>	<u>Horreds</u> <u>NCS</u>	<u>Optional</u> <u>NCS</u>	<u>Veneer</u>
	Wardrobe white direct lam. 432x1296x477mm (BxHxD) incl 1 door, clothes rail, 1 movable shelf and rubber mat.	Push-open, no lock Electronic lock Code lock Cylinder lock	34 xx A00 A31DG 34 xx zyy A31AG 34 xx zyy A31BG 34 xx zyy A31CG	511 681 567 552	565 734 620 606	596 766 652 637	689 859 745 730
	Storage white direct laminate 432x1728x477mm (BxHxD) incl 1 door and 1 fixed shelf.	Push-open, no lock Electronic lock Code lock Cylinder lock	34 xx A00 A41D 34 xx zyy A41A 34 xx zyy A41B 34 xx zyy A41C	360 530 416 401	432 602 488 473	468 638 524 509	553 722 608 593
	Storage white direct laminate 432x1728x477mm (BxHxD) incl 2 doors and 1 fixed shelf.	Push-open, no lock Electronic lock Code lock Cylinder lock	34 xx A00 A42D 34 xx zyy A42A 34 xx zyy A42B 34 xx zyy A42C	390 729 501 472	462 802 574 544	511 850 622 592	611 950 722 692
	Storage white direct laminate 432x1728x477mm (BxHxD) incl 3 doors and 2 fixed shelves.	Push-open, no lock Electronic lock Code lock Cylinder lock	34 xx A00 A43D 34 xx zyy A43A 34 xx zyy A43B 34 xx zyy A43C	453 961 620 575	520 1 029 687 642	610 1 118 777 732	715 1 224 882 837
	Storage white direct laminate 432x1728x477mm (BxHxD) incl 4 doors and 2 fixed shelves.	Push-open, no lock Electronic lock Code lock Cylinder lock	34 xx A00 A44D 34 xx zyy A44A 34 xx zyy A44B 34 xx zyy A44C	508 1 187 731 672	577 1 256 800 741	697 1 375 920 860	791 1 470 1 014 955
	Wardrobe white direct lam. 432x1728x477mm (BxHxD) incl 1 door, clothes rail, 1 movable shelf and rubber mat.	Push-open, no lock Electronic lock Code lock Cylinder lock	34 xx A00 A41DG 34 xx zyy A41AG 34 xx zyy A41BG 34 xx zyy A41CG	570 740 626 611	643 813 699 684	679 848 734 719	763 933 819 804
	Storage white direct laminate 864x432x477mm (BxHxD) incl 2 doors.	Push-open, no lock Electronic lock Code lock Cylinder lock	34 xx A00 B12D 34 xx zyy B12A 34 xx zyy B12B 34 xx zyy B12C	356 695 467 438	390 730 502 472	450 790 562 532	497 837 609 579
	Storage white direct laminate 864x864x477mm (BxHxD) incl 2 doors..	Push-open, no lock Electronic lock Code lock Cylinder lock	34 xx A00 B22D 34 xx zyy B22A 34 xx zyy B22B 34 xx zyy B22C	402 741 513 484	474 814 586 556	523 862 634 604	623 962 734 704

		<u>Door model</u>	<u>Article number</u>	<u>White</u>	<u>Horreds</u> <u>NCS</u>	<u>Optional</u> <u>NCS</u>	<u>Veneer</u>
	Storage white direct laminate 864x864x477mm (BxHxD) incl 4 doors and 2 fixed shelf.	Push-open, no lock	34 xx A00 B24D	549	618	737	831
		Electronic lock	34 xx zyy B24A	1 227	1 296	1 416	1 510
		Code lock	34 xx zyy B24B	772	841	960	1 055
		Cylinder lock	34 xx zyy B24C	712	781	900	995
	Storage white direct laminate 864x1296x477mm (BxHxD) incl 2 doors.	Push-open, no lock	34 xx A00 B32D	520	627	690	876
		Electronic lock	34 xx zyy B32A	859	966	1 029	1 216
		Code lock	34 xx zyy B32B	631	738	802	988
		Cylinder lock	34 xx zyy B32C	601	708	772	958
	Storage white direct laminate 864x1296x477mm (BxHxD) incl 4 doors and 2 fixed shelf.	Push-open, no lock	34 xx A00 B34D	639	745	849	1 060
		Electronic lock	34 xx zyy B34A	1 318	1 424	1 527	1 739
		Code lock	34 xx zyy B34B	863	968	1 072	1 283
		Cylinder lock	34 xx zyy B34C	803	909	1 012	1 224
	Storage white direct laminate 864x1296x477mm (BxHxD) incl 6 doors and 4 fixed shelf.	Push-open, no lock	34 xx A00 B36D	758	861	1 041	1 182
		Electronic lock	34 xx zyy B36A	1 776	1 879	2 059	2 200
		Code lock	34 xx zyy B36B	1 093	1 196	1 375	1 517
		Cylinder lock	34 xx zyy B36C	1 003	1 106	1 286	1 427
	Storage white direct laminate 864x1728x477mm (BxHxD) incl 2 doors and 2 fixed shelves.	Push-open, no lock	34 xx A00 B42D	641	785	857	1 026
		Electronic lock	34 xx zyy B42A	980	1 125	1 196	1 365
		Code lock	34 xx zyy B42B	752	897	968	1 137
		Cylinder lock	34 xx zyy B42C	722	867	938	1 107
	Storage white direct laminate 864x1728x477mm (BxHxD) incl 4 doors and 2 fixed shelves.	Push-open, no lock	34 xx A00 B44D	698	770	939	1 139
		Electronic lock	34 xx zyy B44A	1 376	1 448	1 618	1 818
		Code lock	34 xx zyy B44B	921	993	1 162	1 362
		Cylinder lock	34 xx zyy B44C	861	933	1 102	1 302
	Storage white direct laminate 864x1728x477mm (BxHxD) incl 6 doors and 4 fixed shelves.	Push-open, no lock	34 xx A00 B46D	826	961	1 140	1 351
		Electronic lock	34 xx zyy B46A	1 844	1 979	2 158	2 369
		Code lock	34 xx zyy B46B	1 161	1 296	1 475	1 685
		Cylinder lock	34 xx zyy B46C	1 071	1 206	1 385	1 596
	Storage white direct laminate 864x1728x477mm (BxHxD) incl 8 doors and 6 fixed shelves.	Push-open, no lock	34 xx A00 B48D	946	1 084	1 324	1 512
		Electronic lock	34 xx zyy B48A	2 304	2 442	2 681	2 869
		Code lock	34 xx zyy B48B	1 393	1 531	1 770	1 959
		Cylinder lock	34 xx zyy B48C	1 273	1 411	1 650	1 839

BASES						
		Article number	White	Horreds NCS	Optional NCS	Veneer
	Single base in white direct laminate Selectable material in the front. 430x150x454mm, Incl. adjustable feet	34 xx A10	94	113	124	128
	Double base in white direct laminate Selectable material in the front. 862x150x454mm, Incl adjustable feet.	34 xx A20	102	123	135	143
KNOBS AND HANDLES						
			Prices per door			
	Knob, lettered, Ø17mm, height 28mm Available in black, stainless look and brass look.	Dxx		Black (37)	Stainless (17)	Brass (16)
				11	11	11
	Knob, Ø28mm, height 24mm Available in matte white, matte black, stainless look and brass look.	Cxx	White (31)	Black (37)	Stainless (17)	Brass (16)
			8	8	8	8
	Milled down handle, ø45mm, with backing handle plate. Not for doors in direct laminate.	Bxx		Horreds NCS	Optional NCS	Veneer
				38	43	49
ACCESSORIES						
	Movable shelf 400x448.5mm. For width 432mm.	34 xx 09449	White dir.lam			
	Movable shelf 400x448.5mm. For width 864mm.	34 xx 09470	25			
	Keyboard holder in felt. Inner meas.: W230/D35/H210/80 mm. Attach on inside door. NB: not in combination with the smallest door 432x432 mm.	34 98 08327	(Antracit)	55		
	Removable, shallow shelf 400x402mm. For unit width 432mm. Used in combination with keyboard holder only.	34 31 09479	25			
	Removable, shallow shelf 408x402mm. Till unit width 864mm. Used in combination with keyboard holder only.	34 31 09481	25			

		<u>Article number</u>	<u>White</u>	<u>Horreds NCS</u>	<u>Optional NCS</u>	<u>Veneer</u>
	Shoe shelf 432x270x477mm, including black, rifled rubber mat.	34 xx A001	177	244	304	481
	Shoe shelf 864x270x477mm, including black, rifled rubber mat.	34 xx A002	280	338	408	666
	Add-on module 840x195mm, depth 480mm. Including 2 st plastic plant containers á 170x790x140mm i	34 xx A09480	287	390	473	572
	Seat cushion: contact us for quotation.					
	Foiling numbers Arial 188pt Foil figures, not assembled, price per piece Foil figures, assembled, price per piece	34 37 -F03 34 37 FM03				Black 7 26
	Portable storage box incl pen tray L343/B223/H240 mm.	34 37 06018				51
	User card for electronic lock	371781				16
	Battery for electronic lock Flexlock. Replacment is recommended to be done at a 2 years interval. In order to have your Flexlock work optimally it is required to use this Flexlock battery.	376691				9

COVER PANEL TOP
 • Thickness 19mm
 • Max length top panel is 5 x door width = 2160mm.
 For wider sietups than 5 x door width, the top panel is split.

		<u>Horreds NCS</u>	<u>Optional NCS</u>	<u>Veneer</u>
	Top panel, depth 485mm, price per door width	64	93	106
	Top panel, depth 967mm, price per door width	87	127	148

COVER PANEL SIDE
 • Thickness 19mm

	Side panel, 419x482mm	64	93	106
	Side panel, 581x482mm	64	93	106
	Side panel, 851x482mm	129	187	213
	Side panel, 1013x482mm	129	187	213
	Side panel, 1283x482mm	193	280	319
	Side panel, 1445x482mm	193	280	319
	Side panel, 1715x482mm	257	373	426
	Side panel, 1877x482mm	257	373	426
	Side panel, 2147x482mm	289	420	479
	Side panel, 419x964mm	87	127	148
	Side panel, 581x964mm	87	127	148
	Side panel, 851x964mm	174	254	296
	Side panel, 1013x964mm	174	254	296
	Side panel, 1283x964mm	260	381	443
	Side panel, 1445x964mm	260	381	443
	Side panel, 1715x964mm	347	508	591
	Side panel, 1877x964mm	347	508	591
	Side panel, 2147x964mm	391	572	665



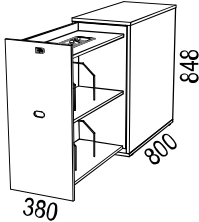
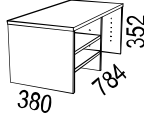
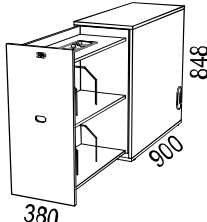
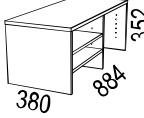
Illustration	Description	Article number	Material	EUR
<p>Biblio Design: Anderssen & Voll</p>				
	<p>Biblio Side Storage</p> <ul style="list-style-type: none"> • Side storage in direct laminated or veneered particle board. • Doors in lacquered or veneered MDF with handles in veneered steel. • The inside is always white. • Stationary shelves. • With clamping knobs. • Max weight capacity: 50 kg. • Lockable. • Chose left or right; images below show units for placement on left side of desk • Can be easily rebuilt from left to right and vice versa. • Note: Dimensions and design changed from 2022. • For additional product information: please see www.horreds.se <p>Material: <u>Veneer group 1:</u> Oak (03), Ash (06) <u>Veneer group 2:</u> Blackst.ash (86), Darkst. ash (76), White pigm.oak(30), White pigm.ash (10) <u>White direct laminate:</u> closest NCS S0300-N</p>	 <p>Colour handles: 03 Oak 06 Ash 75 Black ash 76 Dark ash 30 White Oak 10 White ash 31 White (RAL 9016)</p>		
 	<p>Biblio side storage height 2xA4. <u>Depth 800 mm.</u> Incl.pen tray and brackets.</p> <p><i>Upcharge for front in optional NCS</i> <i>Upcharge for veneered front to white unit</i></p> <p>Open top storage height 1xA4.</p> <p><i>Article numer for side storage prepared for top storage</i></p>	<p>64 3131xx 11BV/H 64 xxxxxx 11BV/H 64 xxxxxx 11BV/H</p> <p>57 31 06400 57 xx 06400 57 xx 06400</p> <p>64 xx 11DV/H</p>	<p>White Veneer group 1 Veneer group 2</p>	<p>1 125 1 707 1 707 231 231 318 622 622</p>
 	<p>Biblio side storage height 2xA4. <u>Depth 900 mm.</u> Incl.pen tray and brackets.</p> <p><i>Upcharge for front in optional NCS</i> <i>Upcharge for veneered front to white unit</i></p> <p>Open top storage height 1xA4.</p> <p><i>Article numer for side storage prepared for top storage</i></p>	<p>64 3131xx 12BV/H 64 xxxxxx 12BV/H 64 xxxxxx 12BV/H</p> <p>57 31 06410 57 xx 06410 57 xx 06410</p> <p>64 xx 12DV/H</p>	<p>White Veneer group 1 Veneer group 2</p>	<p>1 194 1 724 1 724 231 231 331 644 644</p>

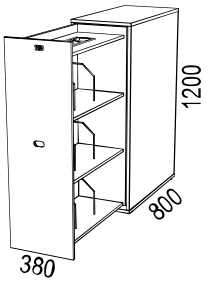
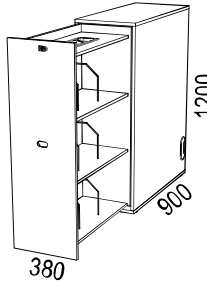
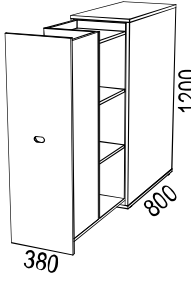
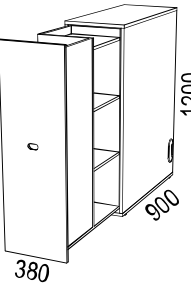
Illustration	Description	Article number	Material	EUR
	Biblio side storage height 3xA4. <u>Depth 800 mm.</u> Incl.pen tray and brackets. <i>Upcharge for front in optional NCS</i> <i>Upcharge for veneered front to white unit</i>	64 3131xx 21BV/H	White	1 266
		64 xxxxxx 21BV/H	Veneer group 1	1 793
		64 xxxxxx 21BV/H	Veneer group 2	1 793
				231
	Biblio side storage height 3xA4. <u>Depth 900 mm.</u> Incl.pen tray and brackets. <i>Upcharge for front in optional NCS</i> <i>Upcharge for veneered front to white unit</i>	64 3131xx 22BV/H	White	1 335
		64 xxxxxx 22BV/H	Veneer group 1	1 811
		64 xxxxxx 22BV/H	Veneer group 2	1 811
				231
BIBLIO SPLIT <ul style="list-style-type: none"> • For 2 users. To be placed between two desks.. • The inside is always white. • Stationary shelves. • Max weight capacity 50 kg. • Not lockable. • Inserts and Hanging file drawer do not fit in Split. 				
	Biblio Split height 3xA4. <u>Depth 800 mm.</u> <i>Upcharge for front in optional NCS</i> <i>Upcharge for veneered front to white unit</i>	64 3131xx 21A	White	1 532
		64 xxxxxx 21A	Veneer group 1	2 058
		64 xxxxxx 21A	Veneer group 2	2 058
				231
	Biblio Split height 3xA4. <u>Depth 900 mm.</u> <i>Upcharge for front in optional NCS</i> <i>Upcharge for veneered front to white unit</i>	64 3131xx 22A	White	1 600
		64 xxxxxx 22A	Veneer group 1	2 076
		64 xxxxxx 22A	Veneer group 2	2 076
				231



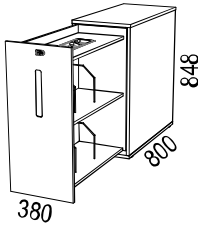
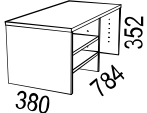
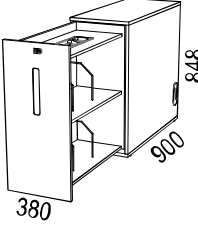
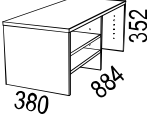
Illustration	Description	Article number	Material	EUR
Nomono Design: Fredrik Mattson				
	<p>Nomono Side Storage</p> <ul style="list-style-type: none"> • Side storage in direct laminated or veneered particle board. • Doors in lacquered or veneered MDF with handles in lacquered steel sheet. • The inside is always white. • Stationary shelves. • With clamping knobs. • Max weight capacity: 50 kg. • Lockable. • Chose left or right; images below show units for placement on left side of desk • Can be easily rebuilt from left to right and vice versa. • Note: Dimensions and design changed from 2022. • For additional product information: please see www.horreds.se <p>Material:</p> <p><u>Veneer group 1:</u> Oak (03), Ash (06)</p> <p><u>Veneer gr. 2:</u> Black ash (86), Dark Ash (76), White oak (30), White ash (10)</p> <p><u>White direct laminate:</u> Closest NCS 0300-N</p> <p>Handle in light brown Elmosoft 54035, upcharge € 70.</p>	 <p>Colour handles:</p> <p>31 White</p> <p>37 Black</p> <p>32 Yellow</p> <p>36 Green</p> <p>33 Red</p> <p>35 Blue</p> <p>42 Orange</p>	<p>Closest ncs:</p> <p>S 0300-N</p> <p>S 9000-N</p> <p>S 1070-Y</p> <p>S 2570-G30Y</p> <p>S 1580-Y80R</p> <p>S 0540-B30G</p> <p>S 1080-Y50R</p>	
 	<p>Nomono side storage height 2xA4. <u>Depth 800 mm.</u> Incl.pen tray and brackets.</p> <p><i>Upcharge for front in optional NCS</i> <i>Upcharge for veneered front to white unit</i></p> <p>Open top storage height 1xA4.</p> <p><i>Article numer for side storage prepared for top storage</i></p>	<p>52 3131xx 11BV/H</p> <p>52 xxxxxx 11BV/H</p> <p>52 xxxxxx 11BV/H</p> <p>57 31 06400</p> <p>57 xx 06400</p> <p>57 xx 06400</p> <p>52 xx 11DV/H</p>	<p>White</p> <p>Veneer group 1</p> <p>Veneer group 2</p> <p>White</p> <p>Veneer group 1</p> <p>Veneer group 2</p>	<p>1 103</p> <p>1 685</p> <p>1 685</p> <p>231</p> <p>231</p> <p>318</p> <p>622</p> <p>622</p>
 	<p>Nomono side storage height 2xA4. <u>Depth 900 mm.</u> Incl.pen tray and brackets.</p> <p><i>Upcharge for front in optional NCS</i> <i>Upcharge for veneered front to white unit</i></p> <p>Open top storage height 1xA4.</p> <p><i>Article numer for side storage prepared for top storage</i></p>	<p>52 3131xx 12BV/H</p> <p>52 xxxxxx 12BV/H</p> <p>52 xxxxxx 12BV/H</p> <p>57 31 06410</p> <p>57 xx 06410</p> <p>57 xx 06410</p> <p>52 xx 12DV/H</p>	<p>White</p> <p>Veneer group 1</p> <p>Veneer group 2</p> <p>White</p> <p>Veneer group 1</p> <p>Veneer group 2</p>	<p>1 172</p> <p>1 702</p> <p>1 702</p> <p>231</p> <p>231</p> <p>331</p> <p>644</p> <p>644</p>

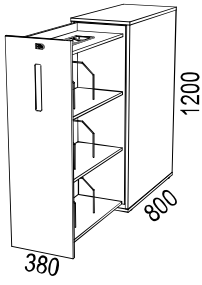
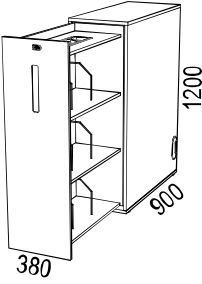
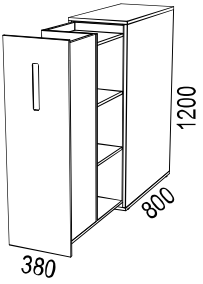
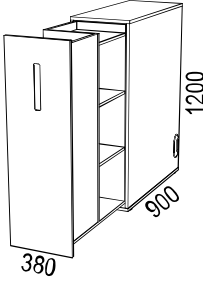
Illustration	Description	Article number	Material	EUR
	Nomono side storage height 3xA4. <u>Depth 800 mm.</u> Incl.pen tray and brackets. <i>Upcharge for front in optional NCS</i> <i>Upcharge for veneered front to white unit</i>	52 3131xx 21BV/H	White	1 244
		52 xxxxxx 21BV/H	Veneer group 1	1 771
		52 xxxxxx 21BV/H	Veneer group 2	1 771
				231
				231
	Nomono side storage height 3xA4. <u>Depth 900 mm.</u> Incl.pen tray and brackets. <i>Upcharge for front in optional NCS</i> <i>Upcharge for veneered front to white unit</i>	52 3131xx 22BV/H	White	1 312
		52 xxxxxx 22BV/H	Veneer group 1	1 788
		52 xxxxxx 22BV/H	Veneer group 2	1 788
				231
				231
<h3>NOMONO SPLIT</h3> <ul style="list-style-type: none"> • For 2 users. To be placed between two desks.. • The inside is always white. • Stationary shelves. • Max weight capacity 50 kg. • Not lockable. • Inserts and Hanging file drawer do not fit in Split. 				
	Nomono Split height 3xA4. <u>Depth 800 mm.</u> <i>Upcharge for front in optional NCS</i> <i>Upcharge for veneered front to white unit</i>	52 3131xx 21A	White	1 509
		52 xxxxxx 21A	Veneer group 1	2 036
		52 xxxxxx 21A	Veneer group 2	2 036
				231
				231
	Nomono Split height 3xA4. <u>Depth 900 mm.</u> <i>Upcharge for front in optional NCS</i> <i>Upcharge for veneered front to white unit</i>	52 3131xx 22A	White	1 578
		52 xxxxxx 22A	Veneer group 1	2 054
		52 xxxxxx 22A	Veneer group 2	2 054
				231
				231



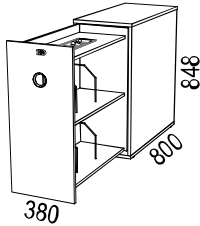
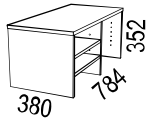
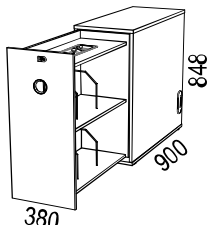
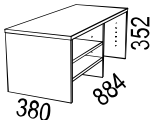
Illustration	Description	Article number	Material	EUR
<p>Siglo Design: Henrik Schulz</p>				
	<p>Siglo Side Storage</p> <ul style="list-style-type: none"> • Side storage in direct laminated or veneered particle board. • Round recess for handle, with ring and plate in white or black plastic as standard. • The inside is always white. • Stationary shelves. • With clamping knobs. • Max weight capacity: 50 kg. • Lockable. • Chose left or right; images below show units for placement on left side of desk • Can be easily rebuilt from left to right and vice versa. • For additional product information; please see www.horreds.se <p>Material: <u>Veneer group 1:</u> Oak (03), Ash (06) <u>Veneer group 2:</u> Blackst.ash (86), Darkst. ash (76), White pigm.oak(30), White pigm.ash (10) <u>White direct laminate:</u> closest NCS S0300-N</p>		<p>Handles standard: 31 White plastic 37 Black plastic</p> <p>Handles optional*: 16 Brass 17 Stainless</p>	
 	<p>Siglo side storage height 2xA4. <u>Depth 800 mm.</u> Incl.pen tray and brackets.</p> <p><i>Upcharge for front in optional NCS</i> <i>Upcharge for veneered front to white unit</i></p> <p>Open top storage height 1xA4.</p> <p><i>Article numer for side storage prepared for top storage</i></p>	<p>60 3131xx 11BV/H 60 xxxxxx 11BV/H 60 xxxxxx 11BV/H</p> <p>60 31 06400 60 xx 06400 60 xx 06400</p> <p>60 xx 11DV/H</p>	<p>White dir.lam. Veneer group 1 Veneer group 2</p> <p>White dir.lam. Veneer group 1 Veneer group 2</p>	<p>1 056 1 612 1 612 259 259</p> <p>356 696 696</p>
 	<p>Siglo side storage height 2xA4. <u>Depth 900 mm.</u> Incl.pen tray and brackets.</p> <p><i>Upcharge for front in optional NCS</i> <i>Upcharge for veneered front to white unit</i></p> <p>Open top storage height 1xA4.</p> <p><i>Article numer for side storage prepared for top storage</i></p>	<p>60 3131xx 12BV/H 60 xxxxxx 12BV/H 60 xxxxxx 12BV/H</p> <p>60 31 06410 60 xx 06410 60 xx 06410</p> <p>60 xx 12DV/H</p>	<p>White dir.lam. Veneer group 1 Veneer group 2</p> <p>White dir.lam. Veneer group 1 Veneer group 2</p>	<p>1 129 1 631 1 631 259 259</p> <p>371 721 721</p>

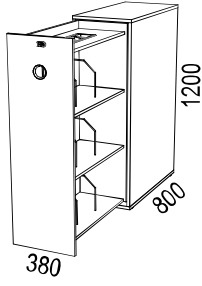
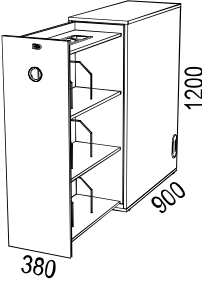
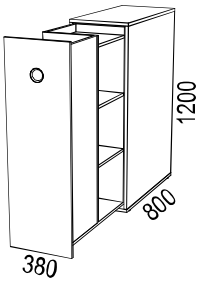
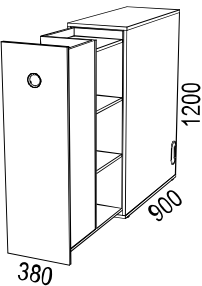
Illustration	Description	Article number	Material	EUR
	Siglo side storage height 3xA4. <u>Depth 800 mm.</u> Incl.pen tray and brackets. <i>Upcharge for front in optional NCS</i> <i>Upcharge for veneered front to white unit</i>	60 3131xx 21BV/H	White dir.lam.	1 207
		60 xxxxxx 21BV/H	Veneer group 1	1 796
		60 xxxxxx 21BV/H	Veneer group 2	1 796
				259
				259
	Siglo side storage height 3xA4. <u>Depth 900 mm.</u> Incl.pen tray and brackets. <i>Upcharge for front in optional NCS</i> <i>Upcharge for veneered front to white unit</i>	60 3131xx 22BV/H	White dir.lam.	1 280
		60 xxxxxx 22BV/H	Veneer group 1	1 815
		60 xxxxxx 22BV/H	Veneer group 2	1 815
				259
				259
<h3>SIGLO SPLIT</h3> <ul style="list-style-type: none"> • For 2 users. To be placed between two desks.. • The inside is always white. • Stationary shelves. • Max weight capacity 50 kg. • Not lockable. • Inserts and Hanging file drawer do not fit in Split. 				
	Siglo Split height 3xA4. <u>Depth 800 mm.</u> <i>Upcharge for front in optional NCS</i> <i>Upcharge for veneered front to white unit</i>	60 3131xx 21A	White dir.lam.	1 489
		60 xxxxxx 21A	Veneer group 1	2 079
		60 xxxxxx 21A	Veneer group 2	2 079
				259
				259
	Siglo Split height 3xA4. <u>Depth 900 mm.</u> <i>Upcharge for front in optional NCS</i> <i>Upcharge for veneered front to white unit</i>	60 3131xx 22A	White dir.lam.	1 563
		60 xxxxxx 22A	Veneer group 1	2 098
		60 xxxxxx 22A	Veneer group 2	2 098
				259
				259

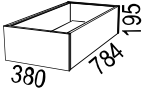
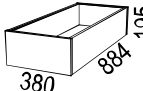
Illustration	Description	Article number	Material	EUR
ACCESSORIES TO SIGLO SIDE STORAGE				
	Add-on module in wood 380x784x195 mm incl. 1 plant container á 170x590x140 mm in recycled plastic	60 31 06365-1 60 xx 06365-1 60 xx 06365-1	White Veneer group 1 Veneer group 2	347 608 608
	Add-on module in wood 380x884x195 mm incl. 1 plant container á 170x790x140 mm in recycled plastic	60 31 06365-2 60 xx 06365-2 60 xx 06365-2	White Veneer group 1 Veneer group 2	347 608 608



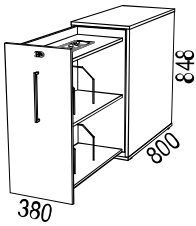
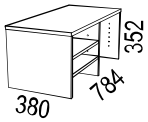
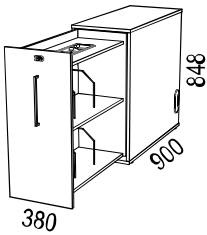
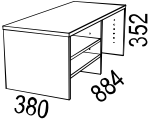
Illustration	Description	Article number	Material	EUR
<p>VX</p>				
<div style="display: flex; justify-content: space-between;"> <div style="width: 25%;">  </div> <div style="width: 50%;"> <h3>VX Side Storage</h3> <ul style="list-style-type: none"> • Side storage in direct laminated or veneered particle board. • The inside is always white. • Stationary shelves. • With clamping knobs. • Max weight capacity: 50 kg. • Lockable. • Chose left or right; images below show units for placement on left side of desk • Can be easily rebuilt from left to right and vice versa. • For additional product information; please see www.horreds.se </div> <div style="width: 20%; text-align: right;">  </div> </div> <div style="margin-top: 20px;"> <p>Material:</p> <p><u>Veneer group 1:</u> Birch (05), Oak (03), Ash (06)</p> <p><u>Veneer group 2:</u> Blackst.ash (86), Darkst. ash (76), White pigm.oak(30), White pigm.ash (10)</p> <p><u>White direct laminate:</u> closest NCS S0300-N</p> </div> <div style="margin-top: 20px;"> <p>Colour handles:</p> <p>31 White</p> <p>37 Black</p> <p>17 Stanless steel look</p> </div>				
 	<p>VX side storage height 2xA4. <u>Depth 800 mm.</u> Incl.pen tray and brackets.</p> <p><i>Upcharge for front in optional NCS</i> <i>Upcharge for veneered front to white unit</i></p> <p>Open top storage height 1xA4.</p> <p><i>Article numer for side storage prepared for top storage</i></p>	<p>34 3131xx 11BV/H</p> <p>34 xxxxxx 11BV/H</p> <p>34 xxxxxx 11BV/H</p> <p>57 31 06400</p> <p>57 xx 06400</p> <p>57 xx 06400</p> <p>34 xx 11DV/H</p>	<p>White dir.lam.</p> <p>Veneer group 1</p> <p>Veneer group 2</p> <p>White dir.lam.</p> <p>Veneer group 1</p> <p>Veneer group 2</p>	<p>942</p> <p>1 438</p> <p>1 438</p> <p>231</p> <p>231</p> <p>318</p> <p>622</p> <p>622</p>
 	<p>VX side storage height 2xA4. <u>Depth 900 mm.</u> Incl.pen tray and brackets.</p> <p><i>Upcharge for front in optional NCS</i> <i>Upcharge for veneered front to white unit</i></p> <p>Open top storage height 1xA4.</p> <p><i>Article numer for side storage prepared for top storage</i></p>	<p>34 3131xx 12BV/H</p> <p>34 xxxxxx 12BV/H</p> <p>34 xxxxxx 12BV/H</p> <p>57 31 06410</p> <p>57 xx 06410</p> <p>57 xx 06410</p> <p>34 xx 12DV/H</p>	<p>White dir.lam.</p> <p>Veneer group 1</p> <p>Veneer group 2</p> <p>White dir.lam.</p> <p>Veneer group 1</p> <p>Veneer group 2</p>	<p>1 007</p> <p>1 455</p> <p>1 455</p> <p>231</p> <p>231</p> <p>331</p> <p>644</p> <p>644</p>

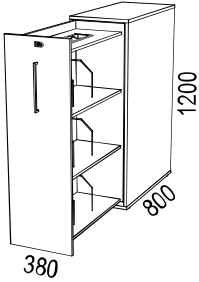
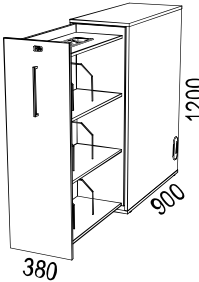
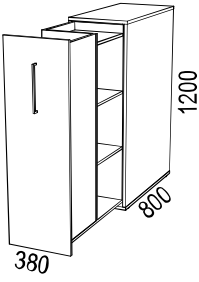
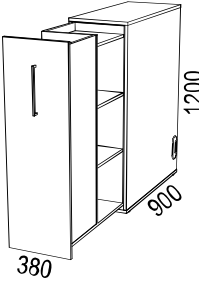
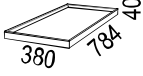
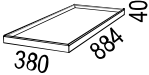

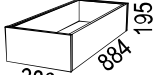


Illustration	Description	Article number	Material	EUR
	VX side storage height 3xA4. <u>Depth 800 mm.</u> Incl.pen tray and brackets. <i>Upcharge for front in optional NCS</i> <i>Upcharge for veneered front to white unit</i>	34 3131xx 21BV/H	White dir.lam.	1 077
		34 xxxxxx 21BV/H	Veneer group 1	1 602
		34 xxxxxx 21BV/H	Veneer group 2	1 602
				231
				231
	VX side storage height 3xA4. <u>Depth 900 mm.</u> Incl.pen tray and brackets. <i>Upcharge for front in optional NCS</i> <i>Upcharge for veneered front to white unit</i>	34 3131xx 22BV/H	White dir.lam.	1 142
		34 xxxxxx 22BV/H	Veneer group 1	1 619
		34 xxxxxx 22BV/H	Veneer group 2	1 619
				231
				231
VX SPLIT <ul style="list-style-type: none"> • For 2 users. To be placed between two desks.. • The inside is always white. • Stationary shelves. • Max weight capacity 50 kg. • Not lockable. • Inserts and Hanging file drawer do not fit in Split. 				
	VX Split height 3xA4. <u>Depth 800 mm.</u> <i>Upcharge for front in optional NCS</i> <i>Upcharge for veneered front to white unit</i>	34 3131xx 21A	White dir.lam.	1 329
		34 xxxxxx 21A	Veneer group 1	1 855
		34 xxxxxx 21A	Veneer group 2	1 855
				231
				231
	VX Split height 3xA4. <u>Depth 900 mm.</u> <i>Tillägg för lackad front i valfri NCS</i> <i>Tillägg för fanerad front (stomme i dir.lam)</i>	34 3131xx 22A	White dir.lam.	1 394
		34 xxxxxx 22A	Veneer group 1	1 871
		34 xxxxxx 22A	Veneer group 2	1 871
				231
				231

Illustration	Description	Article number	Material	EUR
ACCESSORIES TO SIDE STORAGE				
	Tray 380x784x40 mm	64 xx 08750-080	Veneer group 1	474
		64 xx 08750-080	Veneer group 2	474
	Tray 380x884x40 mm	64 xx 08750-090	Veneer group 1	474
		64 xx 08750-090	Veneer group 2	474
	Add-on module in wood 380x784x195 mm incl. 1 plant container á 170x590x140 mm in recycled plastic	57 31 06365-1	White dir.lam.	311
		57 xx 06365-1	Veneer gr 1	546
		57 xx 06365-1	Veneer gr 1	546
	Add-on module in wood 380x884x195 mm incl. 1 plant container á 170x790x140 mm in recycled plastic	57 31 06365-2	White dir.lam.	311
		57 xx 06365-2	Veneer gr 1	546
		57 xx 06365-2	Veneer gr 1	546
	Hanging file drawer, assembled on expansion track <i>Does not fit in Split.</i>	57 31 03160	White	177
	Shallow insert in direct laminate with fronts in lacquer. 2 drawers. The top drawer incl a plastic pen drawer. <i>Does not fit in Split.</i>	57 31 082	White/White	292
		57 3199 082	White/Opt.NCS fronts	401

MEETING TABLES INFO



Here is a presentation of our various stands for meeting tables.

Information regarding table tops, see next page.

VX Conference

- Fixed T-leg stand in height 73 and 90 cm. White RAL9016 and black RAL 9005.
- Electric T-leg stand in height 70-120 cm for format MA, others formats 7. White RAL9016 and black RAL 9005.
- Tables in format MA (max. width 90 cm) is delivered with T-legs in dimension 80x50 mm with standard T-foot 70 cm. Solid foot as an option. Cable entries \varnothing 80 mm and Powerdots max \varnothing 60 mm are suitable for these tables.
- Tables in format MF, MG and MH (max. width 120 cm) are delivered with T-legs in dimension 80x50 mm with solid T-foot 70 cm.
- Tables in formats MG+ and MH+ (width 130-140 cm) are delivered with T-legs in dimension 70x70 mm with solid T-foot 90 cm.



VX Project

- Square legs (7x7cm) in metal or solid wood (standard).
- Round legs (\varnothing 10cm) in solid wood.
- Metal legs: White RAL9016, Black RAL9005 and 8 optional colours.
- Wooden legs: oak (03), ash (06), white oak (30), white ash (10), black ash (86), dark ash (76), Burgundy stained ash (C8), Conifer stained ash (D3), Smokey Blue stained ash (D4).
- Steel frame (white / black) or anodized aluminum frame.
- Table height 73 and 90 cm.
- Minimum width in standard version is 120 cm due to legroom and cable hole limitations. If you are interested in a table in width 100 or 90 cm; contact us for a proposal/quote.



A-Frame stativ

Design: Anderssen & Voll

- A-stand in solid oak or ash with steel legs in white RAL9016 or Black RAL9005. Colour codes wooden legs: oak (03), ash (06), white oak (30), white ash (10), black ash (86), dark ash (76), Burgundy stained ash (C8), Conifer stained ash (D3), Smokey Blue stained ash (D4).
- Fits table sizes 1800-2400 x 900-1200 mm.
- Fixed table height 73 and 90 cm.
- Electric table height 70-120 cm for format MA, 73-110cm for format MG



Table material:**High pressure laminate:**

	Closest NCS:
White HPL 0754 (31)	S0502-Y
Light grey HPL 0419 (2A)	S2002-Y
Light grey HPL 1365 (2B)	S2005-R80B
Medium grey HPL 1023 (2C)	S5500-N
Anthracite HPL 1397 (2D)	S7500-N
Black HPL 2253 (2E)	S9000-N

Colours metal:

1019 Grey Beige (3H)	Optional VX projekt
1024 Ochre yellow (3G)	Optional VX projekt
3007 Black red (3D)	Optional VX projekt
5008 Grey blue (3C)	Optional VX projekt
6009 Fir green (3L)	Optional VX projekt
6013 Reed green (3K)	Optional VX projekt
7039 Quartz grey (3J)	Optional VX projekt
7044 Silk grey (3A)	Optional VX projekt
9005 Jet black (37)	Standard VX / A-Frame
9016 Traffic white (31)	Standard VX / A-Frame

Linoleum:

	Closest NCS:
4132 Ash	5502-G
4154 Burgundy	7010-R10B
4166 Charcoal	8502-B
4172 Mauve	7005-Y80R
4174 Conifer	8010-B90G
4175 Pebble	3502-Y
4176 Mushroom	2002-Y
4177 Vapour	2005-G10Y
4179 Smokey Blue	7010-R90B
4184 Olive	5010-G50Y

Veneer group 1:

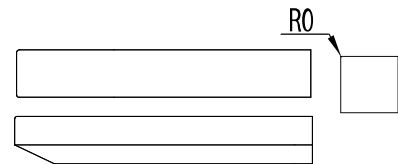
Birch* (05)
Oak (03)
Ash (06)

Veneer group 2:

White pigm. oak (30)**
Black stained ash (86)**
White pigmented ash (10)**
Dark stained ash (76)**
Burgundy stained ash (C8)**
Conifer stained ash (D3)**
Smokey Blue stain.ash (D4)**

*=*not A-frame***=*not Henry***Bordsskivor:**  MÖBELFAKTA**VX**

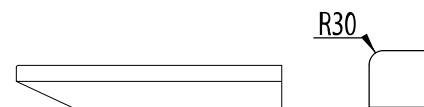
- VX desk tops are made of 19 mm MDF with edging in matching colour.
- Option: chamfered edge
- Corner radius 0 mm.

**VX radius 50**

- VX desk tops with rounded corners are made of 19 mm MDF with edging in matching colour
- Corner radius 50

**Fri** Design: Bror Boije

- Fri desk tops are made of 19 mm MDF with chamfered, clear coated edge.
- Corner radius 30 mm.

**A-Frame** Design: Anderssen & Voll

- A-Frame desk tops are made of 19 mm MDF with edging in matching colour.
- Corner radius 0 mm.



- For more product information see www.horreds.se

MEETING TABLES

MA

Meeting tables within size 2000x900 mm.

VX T-legs are delivered with 700 mm standard foot, massive foot as option.

A-Frame is delivered with a leg stand in solid wood and legs in steel.

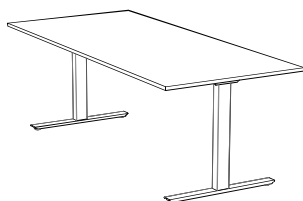
This format is not possible with a centered cable cover.

When ordering, state the desired table size, profile, material and colour and height of the stand.

Table top (excluding legs)	White HPL (31)	Optional HPL (39)	Linoleum (88)	Veneer group 1	Veneer group 2
Series: Radius: Edge profile:					
VX (3416) * 0 mm Straight / matching list	482	592	702	488	488
VX (3417) * 0 mm Chamfered / matching list	594	704	814	600	600
VX (3418) * 50 mm Straight / matching list	515	629	789	528	528
Fri (3513) 30 mm Chamfered / MDF	528	642	801	487	487
A-Frame (64) * 0mm Straight / matching list	516	633	752	523	523
* Upcharge for veneer edging on laminate	104	104			
* Upcharge for veneer edging on linoleum. Note: Only oak/ash nature and white pigmented. Not possible on stained tables.			104		
Possible cable entry: max ø 80 and Powerdot max ø 60 mm.					

Stativ (exklusive bordsskiva):	White (31) Black (37)	Optional colours	Oak (03) Ash (06)	Stain / White pigm..
VX T-legs fixed table height 73cm	602			
VX T-legs fixed table height 90cm	629			
VX T-legs electrical 61-126 cm	1 193			
Upcharge for massive feet	202			
A-Frame fixed table height 73cm			985	985
A-Frame fixed table height 90cm			1020	1020
A-Frame electrical 70-120cm			1917	1917

VX T-legs

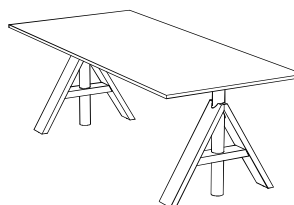


Sizes:

Längd 1800-2000 mm

Bredd 900 mm

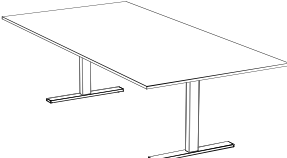

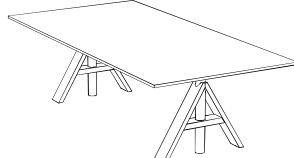
A-Frame

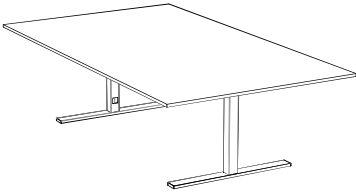
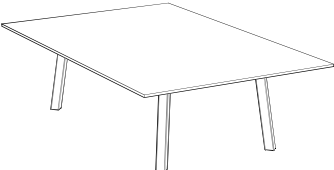


Sizes:

Längd 1800-2000 mm

Bredd 900 mm

MEETING TABLES								
MF		Meeting tables within size 2400x1200 mm.						
<p>VX T-legs are delivered with solid steel foot 700 mm. VX Project Stand is delivered with slanted legs in wood or metal. A-Frame is delivered with a leg stand in solid wood and legs in steel. When ordering, state the desired table size, profile, material and colour and height of the stand.</p>								
Table top (excluding legs)			White dir. laminate (31D)	White HPL (31)	Optional HPL (39)	Linoleum (88)	Veneer group 1	Veneer group 2
Series:	Radius:	Edge profile:						
VX (3416) *	0 mm	Straight / matching list	661	696	751	1 115	803	803
VX (3417) *	0 mm	Chamfered / matching list	697	732	787	1 151	849	849
VX (3418) *	50 mm	Straight / matching list	696	733	790	1 174	845	845
Fri (3513)	30 mm	Chamfered / MDF	734	771	828	1 212	893	893
A-Frame (64)	0mm	Straight / matching list	696	733	790	1 174	845	845
* Upcharge for veneer edging on laminate				104	104			
* Upcharge for veneer edging on linoleum. Note: Only oak/ash nature and white pigmented. Not possible on stained tables.						104		
Stand (excluding table top):					White (31) Black (37)	Optional colours	Oak (03) Ash (06)	Stain / White pigm..
VX Conference , 2xT-legs with solid 70cm foot, table height 73cm					886			
VX Conference , 2xT-legs with solid 70cm foot, table height 90cm					913			
VX Conference 2xT-legs electrical 73-110cm					1 519			
VX Project , 4xlegs, steel frame, table height 73cm					1 366	1 523	1 366	1 445
VX Project , 4xlegs, steel frame, table height 90cm					1 513	1 670	1 513	1 592
Upcharge for wooden legs with round profile							92	92
A-Frame conference , white / black legs, table height 73cm							1 194	1 194
A-Frame conference , white / black legs, table height 90cm							1 228	1 228
A-frame conference electrical 73-110cm							2 089	2 089
VX Conference			VX Project			A-Frame		
								
Sizes: Length 2000-2400 mm Width 900-1200 mm			Sizes: Length 2000-2400 mm Width 1200 mm			Sizes: Length 2000-2400 mm Width 900-1200 mm		

MEETING TABLES						
MF+ Meeting tables within size 2400x1400 mm.						
VX Conference is delivered with solid steel foot 900 mm. Wiring through the leg possible.						
VX Project Stand is delivered with slanted legs in wood or metal.						
When ordering, state the desired table size, profile, material and colour and height of the stand.						
Table top (excluding legs)	White dir. laminate (31D)	White HPL (31)	Optional HPL (39)	Linoleum (88)	Veneer group 1	Veneer group 2
Series: Radius: Edge profile:						
VX (3416) * 0 mm Straight / matching list	721	1 153		1 409	1 640	1 640
VX (3417) * 0 mm Chamfered / matching list	757	1 189		1 445	1 687	1 687
VX (3418) * 50 mm Straight / matching list	760	1 214		1 483	1 728	1 728
Fri (3513) 30 mm Chamfered / MDF	797	1 252		1 521	1 775	1 775
A-Frame (64) 0mm Straight / matching list		104				
* Upcharge for veneer edging on laminate				104		
* Upcharge for veneer edging on linoleum. Note: Only oak/ash nature and white pigmented. Not possible on stained tables.						
Stand (excluding table top):			White (31) Black (37)	Optional colours	Oak (03) Ash (06)	Stain / White pigm..
VX Conference, 2xT-legs with solid 90cm foot, table height 73cm			1 757			
VX Conference, 2xT-legs with solid 90cm foot, table height 90cm			1 859			
VX Conference 2xT-legs electrical 70-106cm			3 551			
VX Project, 4xlegs, steel frame, table height 73cm			1 366	1 523	1 366	1 445
VX Project, 4xlegs, steel frame, table height 90cm			1 513	1 670	1 513	1 592
Upcharge for wooden legs with round profile					92	92
<p>VX Conference</p>  <p>Sizes: Length 2000-2400 mm Width 1300-1400 mm</p>		<p>VX Project</p>  <p>Sizes: Length 2000-2400 mm Width 1300-1400 mm</p>				

MEETING TABLES

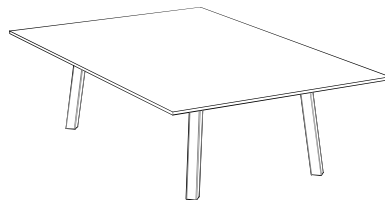
MF++ Meeting tables within size 2400x1600 mm.

VX Project Stand is delivered with slanted legs in wood or metal.

When ordering, state the desired table size, profile, material and colour and height of the stand.

Table top (excluding legs)	White dir. laminate (31D)	White HPL (31)	Optional HPL (39)	Linoleum (88)	Veneer group 1	Veneer group 2
Series: VX (3416) * Radius: 0 mm Edge profile: Straight / matching list	982	1 522		1 915	1 828	2 045
* Upcharge for veneer edging on laminate		104				
* Upcharge for veneer edging on linoleum. Note: Only oak/ash nature and white pigmented. Not possible on stained tables.				104		
Stand (excluding table top):			White (31) Black (37)	Optional colours	Oak (03) Ash (06)	Stain / White pigm..
VX Project, 4xlegs, steel frame, table height 73cm			1 366	1 523	1 366	1 366
VX Project, 4xlegs, steel frame, table height 90cm			1 513	1 670	1 513	1 513
Upcharge for wooden legs with round profile					92	92

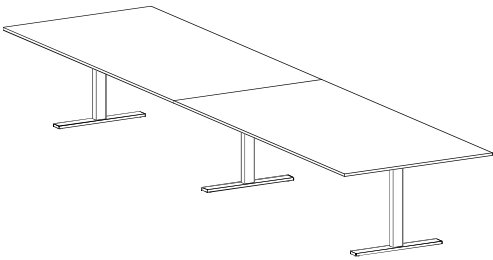
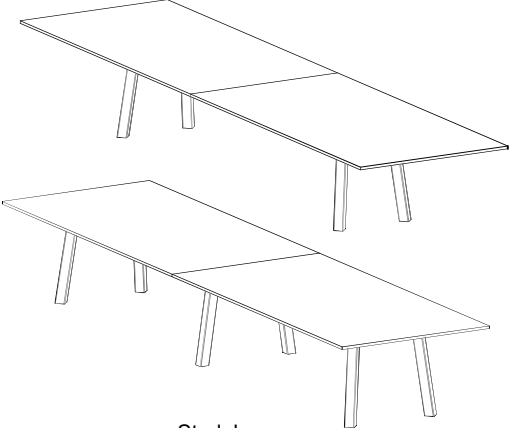
VX Project



Sizes:

Length 2000-2400 mm

Width 1500-1600 mm

MEETING TABLES						
<h1>MG</h1> <p>2-piece Meeting tables within size 4800x1200</p> <p>VX T-legs are delivered with solid steel foot 700 mm. VX Project Stand is delivered with slanted legs in wood or metal. When ordering, state the desired table size, profile, material and colour and height of the stand.</p>						
Table top (excluding legs)	White dir. laminate (31D)	White HPL (31)	Optional HPL (39)	Linoleum (88)	Veneer group 1	Veneer group 2
Series: Radius: Edge profile: VX (3416) * 0 mm Straight / matching list, 2 pcs VX (3417) * 0 mm Chamfered / matching list, 2 pcs VX (3418) * 50 mm Straight / matching list, 2 pcs Fri (3513) 30 mm Chamfered / MDF, 2 pcs	1 431	1 501	1 556	2 339	1 713	1 713
	1 503	1 574	1 628	2 411	1 806	1 806
	1 506	1 580	1 638	2 462	1 804	1 804
	1 582	1 656	1 713	2 538	1 901	1 901
* Upcharge for veneer edging on laminate		104	104			
* Upcharge for veneer edging on linoleum. Note: Only oak/ash nature and white pigmented. Not possible on stained tables.				104		
Stand (excluding table top):			White (31) Black (37)	Optional colours	Oak (03) Ash (06)	Stain / White pigm..
VX Conference , 3xT-legs with solid 70cm foot, table height 73cm VX Conference , 3xT-legs with solid 70cm foot, table height 90cm			1 512 1 553			
VX Project , 4xlegs, aluminium frame, table height 73cm VX Project , 4xlegs, aluminium frame, table height 90cm Upcharge for wooden legs with round profile			2 450 2 597	2 606 2 754	2 450 2 597 92	2 528 2 675 92
VX Projekt , 6xlegs steel frame, table height 73cm VX Projekt , 6xlegs steel frame, table height 90cm Upcharge for wooden legs with round profile			2 297 2 515	2 531 2 750	2 297 2 515 138	2 414 2 633 138
<div style="display: flex; justify-content: space-around;"> <div style="text-align: center;"> <p>VX Conference</p>  <p>Storlekar: Length max 4800 mm Width 900-1200 mm</p> </div> <div style="text-align: center;"> <p>VX Project</p>  <p>Storlekar: Length max 4800 mm Width 1200 mm</p> </div> </div>						

MEETING TABLES

MG+ 2-piece Meeting tables within size 4800x1400

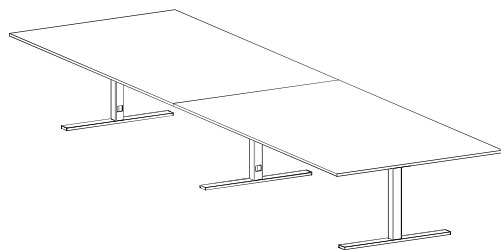
VX T-legs are delivered with solid steel foot 700 mm.

VX Project Stand is delivered with slanted legs in wood or metal.

When ordering, state the desired table size, profile, material and colour and height of the stand.

Table top (excluding legs)			White dir. laminate (31D)	White HPL (31)	Optional HPL (39)	Linoleum (88)	Veneer group 1	Veneer group 2
Serie	Hörnradie	Kantprofil						
VX (3416) *	0 mm	Straight / matching list, 2 pcs	1 552	2 415		2 927	3 389	3 389
VX (3417) *	0 mm	Chamfered / matching list, 2 pcs	1 623	2 488		2 999	3 482	3 482
VX (3418) *	50 mm	Straight / matching list, 2 pcs	1 633	2 543		3 081	3 586	3 586
Fri (3513)	30 mm	Chamfered / MDF, 2 pcs	1 709	2 618		3 157	3 665	3 665
* Upcharge for veneer edging on laminate				104				
* Upcharge for veneer edging on linoleum. Note: Only oak/ash nature and white pigmented. Not possible on stained tables.						104		0
Stand (excluding table top):					White (31) Black (37)	Optional colours	Oak (03) Ash (06)	Stain / White pigm..
VX Conference , 3xT-legs with solid 70cm foot, table height 73cm					2 883			
VX Conference , 3xT-legs with solid 70cm foot, table height 90cm					3 035			
VX Project , 4xlegs, aluminium frame, table height 73cm					2 450	2 606	2 450	2 528
VX Project , 4xlegs, aluminium frame, table height 90cm					2 597	2 754	2 597	2 675
Upcharge for wooden legs with round profile							92	92
VX Projekt , 6xlegs steel frame, table height 73cm					2 297	2 531	2 297	2 414
VX Projekt , 6xlegs steel frame, table height 90cm					2 515	2 750	2 515	2 633
Upcharge for wooden legs with round profile							138	138

VX Conference

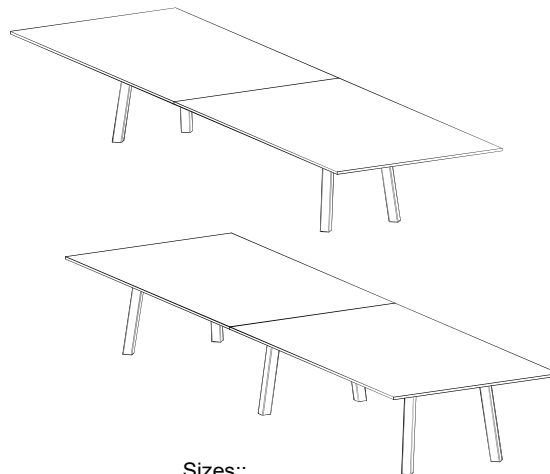


Sizes::

Length max 4800 mm

Width 1300-1400 mm

VX Project



Sizes::

Length max 4800 mm

MEETING TABLES

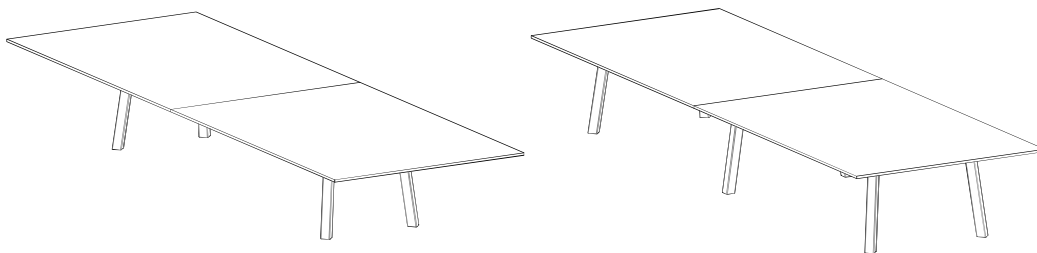
MG++ 2-piece Meeting tables within size 4800x1600

VX Project Stand is delivered with slanted legs in wood or metal.

When ordering, state the desired table size, profile, material and colour and height of the stand.

Table top (excluding legs)	White dir. laminate (31D)	White HPL (31)	Optional HPL (39)	Linoleum (88)	Veneer group 1	Veneer group 2
Series: Radius: Edge profile: VX (3416) * 0 mm Straight / matching list, 2 pcs	2 073	3 165		3 950	3 765	3 765
* Upcharge for veneer edging on laminate		104				
* Upcharge for veneer edging on linoleum. Note: Only oak/ash nature and white pigmented. Not possible on stained tables.				104		
Stand (excluding table top):			White (31) Black (37)	Optional colours	Oak (03) Ash (06)	Stain / White pigm..
VX Project , 4xlegs, aluminium frame, table height 73cm			2 450	2 606	2 450	2 528
VX Project , 4xlegs, aluminium frame, table height 90cm			2 597	2 754	2 597	2 675
Upcharge for wooden legs with round profile					92	92
VX Projekt , 6xlegs steel frame, table height 73cm			2 297	2 531	2 297	2 414
VX Projekt , 6xlegs steel frame, table height 90cm			2 515	2 750	2 515	2 633
Upcharge for wooden legs with round profile					138	138

VX Project



Sizes:
Length max 4800 mm
Width 1500-1600 mm

MEETING TABLES

MH

3-piece Meeting tables within size 7200x1200

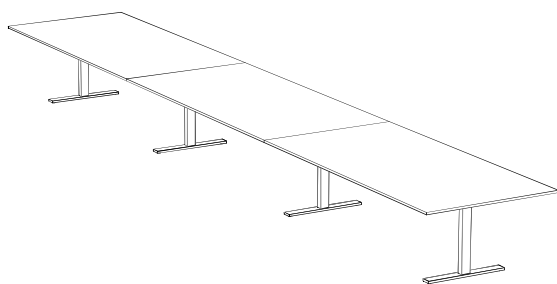
VX T-legs are delivered with solid steel foot 700 mm.

VX Project Stand is delivered with slanted legs in wood or metal.

When ordering, state the desired table size, profile, material and colour and height of the stand.

Table top (excluding legs)	White dir. laminate (31D)	White HPL (31)	Optional HPL (39)	Linoleum (88)	Veneer group 1	Veneer group 2
Series: Radius: Edge profile:						
VX (3416) * 0 mm Straight / matching list, 3 pcs	2 146	2 252	2 334	3 509	2 570	2 570
VX (3417) * 0 mm Chamfered / matching list, 3 pcs	2 254	2 360	2 442	3 617	2 710	2 710
VX (3418) * 50 mm Straight / matching list, 3 pcs	2 259	2 371	2 457	3 694	2 706	2 706
Fri (3513) 30 mm Chamfered / MDF, 3 pcs	2 373	2 485	2 570	3 808	2 852	2 852
* Upcharge for veneer edging on laminate		104	104			
* Upcharge for veneer edging on linoleum. Note: Only oak/ash nature and white pigmented. Not possible on stained tables.				104		
Stand (excluding table top):			White (31) Black (37)	Optional colours	Oak (03) Ash (06)	Stain / White pigm..
VX Conference , 4xT-legs with solid 70cm foot, table height 73cm			2 125			
VX Project , 6xlegs, aluminum frame, table height 73cm			3 531	3 765	3 531	3 648
Upcharge for wooden legs with round profile					138	138

VX Conference

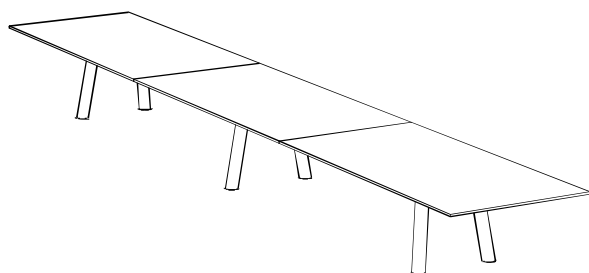


Sizes:

Length max 7200 mm

Width 1000-1200 mm

VX Project



Sizes:

Length max 7200 mm

Width 1200 mm

MEETING TABLES

MH+

3-piece Meeting tables within size 7200x1400

VX Conference is delivered with solid steel foot 900 mm. Wiring through the leg possible.

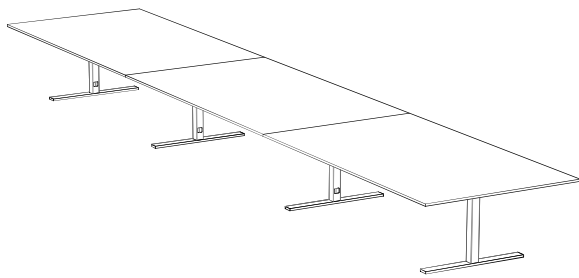
VX Project Stand is delivered with slanted legs in wood or metal.

When ordering, state the desired table size, profile, material and colour and height of the stand.

Table top (excluding legs)	White dir. laminate (31D)	White HPL (31)	Optional HPL (39)	Linoleum (88)	Veneer group 1	Veneer group 2
Series: Radius: Edge profile:						
VX (3416) * 0 mm Straight / matching list, 3 pcs	2 327	3 623		4 390	5 084	5 084
VX (3417) * 0 mm Chamfered / matching list, 3 pcs	2 435	3 731		4 499	5 223	5 223
VX (3418) * 50 mm Straight / matching list, 3 pcs	2 450	3 814		4 621	5 360	5 360
Fri (3513) 30 mm Chamfered / MDF, 3 pcs	2 564	3 928		4 735	5 498	5 498
* Upcharge for veneer edging on laminate		104				
* Upcharge for veneer edging on linoleum. Note: Only oak/ash nature and white pigmented. Not possible on stained tables.				104		

Stand (excluding table top):	White (31) Black (37)	Optional colours	Oak (03) Ash (06)	Stain / White pigm..
VX Conference , 4xT-legs with solid 90cm foot, table height 73cm	4 010			
VX Project , 6xlegs, aluminum frame, table height 73cm	3 531	3 765	3 531	3 648
Upcharge for wooden legs with round profile			138	138

VX Conference

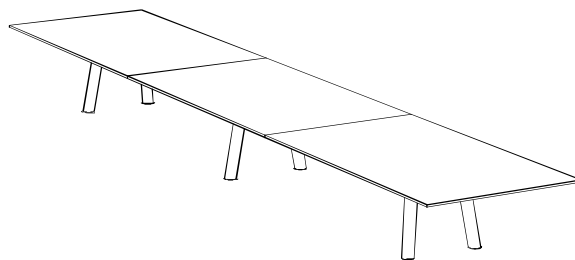


Sizes:

Length max 7200 mm

Width 1300-1400 mm

VX Project



Sizes:

Length max 7200 mm

Width 1300-1400 mm

MEETING TABLES

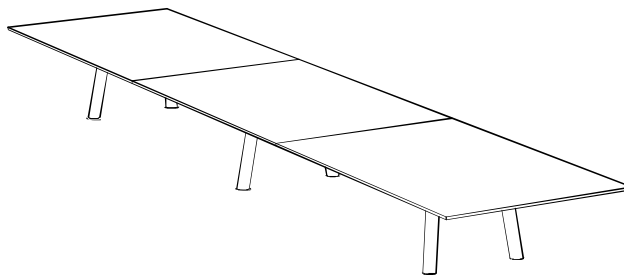
MH++ 3-piece Meeting tables within size 7200x1600

VX Project Stand is delivered with slanted legs in wood or metal.

When ordering, state the desired table size, profile, material and colour and height of the stand.

Table top (excluding legs)	White dir. laminate (31D)	White HPL (31)	Optional HPL (39)	Linoleum (88)	Veneer group 1	Veneer group 2
Series: VX (3416) * Radius: 0 mm Edge profile: Straight / matching list, 3 pcs * Upcharge for veneer edging on laminate * Upcharge for veneer edging on linoleum. Note: Only oak/ash nature and white pigmented. Not possible on stained tables.	3 163	4 807 104		5 985 104	5 701	5 701
Stand (excluding table top):			White (31) Black (37)	Optional colours	Oak (03) Ash (06)	Stain / White pigm..
VX Procekt, 6xlegs, aluminum frame, desk height 73cm			3 531	3 765	3 531	3 648
Upcharge for wooden legs with round profile					138	138

VX Project



Sizes:

Length max 7200 mm

Width 1500-1600 mm

MEETING TABLES

Q

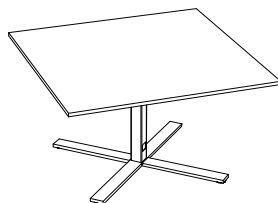
Square tables

VX Conference is delivered with a solid cross base. Wiring through the leg possible.
When ordering, state the desired table size, profile, material and colour and height of the stand.

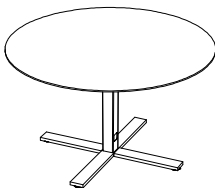
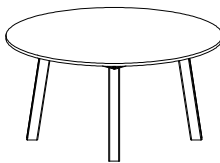
Table top (excluding legs)	White dir. laminate (31D)	White HPL (31)	Optional HPL (39)	Linoleum (88)	Veneer group 1	Veneer group 2
Series: Radius: Edge profile:						
VX (3416) * 0 mm Straight / matching list	368	387	477	477	458	458
VX (3417) * 0 mm Chamfered / matching list	474	500	589	589	570	570
VX (3418) * 50 mm Straight / matching list	514	541	666	666	640	640
Fri (3513) 30 mm Chamfered / MDF	504	531	654	654	627	627
* Upcharge for veneer edging on laminate		104	104			
* Upcharge for veneer edging on linoleum. Note: Only oak/ash nature and white pigmented. Not possible on stained tables.				104		

VX Conference Cross foot* in table height 730 mm for table tops sizes:	White (31) Black (37)
600X600-900x900 mm	445
Upcharge for stand in height 1060 mm	31

* Outgoing product, sold only as long as stock lasts. Contact customer support for stock status.



- Sizes (mm):
- 600x600
 - 700x700
 - 800x800
 - 900x900

MEETING TABLES									
R1 Round meeting tables max diameter 1400									
VX Conference is delivered with a solid cross base. Wiring through the leg possible.									
VX Project Stand is delivered with slanted legs in wood or metal.									
When ordering, state the desired table size, profile, material and colour and height of the stand.									
Series	Radius	Edge profile	White dir. laminate (31D)	White HPL (31)	Optional HPL (39)	Linoleum (88)	Veneer group 1	Veneer group 2	
Round table tops ø 600 - 900 mm (excluding legs)									
VX (3416) *	0 mm	Straight / matching list	368	387	477	477	458	458	
VX (3417) *	0 mm	Chamfered / matching list	474	500	589	589	570	570	
Fri (3513)	30 mm	Chamfered / MDF	504	531	654	654	627	627	
Round table tops ø 1000 - 1200 mm (excluding legs)									
VX (3416) *	0 mm	Straight / matching list	444	468	573	662	529	529	
VX (3417) *	0 mm	Chamfered / matching list	551	580	685	774	641	641	
Fri (3513)	30 mm	Chamfered / MDF	608	641	785	907	725	725	
Round table top ø 1400 mm (excluding legs)									
VX (3416) *	0 mm	Straight / matching list	721	1 153		1 409	1 640	1 640	
VX (3417) *	0 mm	Chamfered / matching list	757	1 189		1 445	1 687	1 687	
Fri (3513)	30 mm	Chamfered / MDF	797	1 252		1 521	1 775	1 775	
Option: cable lid 980									
* Upcharge for veneer edging on laminate				104					
* Upcharge for veneer edging on linoleum. Note: Only oak/ash nature and white pigmented. Not possible on stained tables.						104			
VX Conference Cross foot * in table height 730 mm for table tops sizes:			Vit (31)						
600-900 mm			Svart (37)						
Upcharge for stand in height 1060 mm			445						
			31						
* Utgående produkt, säljes endast så lång lagret räcker. Kontakta kundsupport för lagerstatus.									
VX Project 4xlegs with steel frame:			White (31) Black (37)	Optional colours	Oak (03) Ash (06)	Stain / White pigm..			
Desk height 730 mmm			1 366	1 523	1 366	1 445			
Desk height 900 mm			1 513	1 670	1 513	1 592			
Upcharge for wooden legs with round profile					92	92			
VX Conference			VX Project						
									
Sizes (mm): Ø 600, 700, 800, 900.			Sizes (mm): Ø 1000, 1200, 1400.						

MEETING TABLES

R2

2-piece meeting tables max 2400x2400 mm

VX Project Stand is delivered with slanted legs in wood or metal.

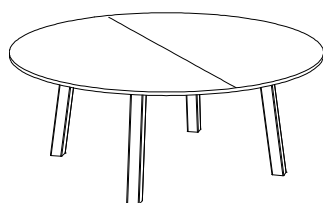
When ordering, state the desired table size, profile, material and colour and height of the stand.

No matching of veneer.

Round/square able tops ø 1500 - 2400 mm (excluding legs)	White dir. laminate (31D)	White HPL (31)	Optional HPL (39)	Linoleum (88)	Veneer group 1	Veneer group 2
Serie Hörnradie Kantprofil						
VX (3416) 0 mm Rak med matchande kantlist, 2 st	1 431	1 501	1 556	2 339	1 713	1 713
VX (3417) 0 mm Fasad med matchande kantlist, 2 st	1 503	1 574	1 628	2 411	1 806	1 806
Fri (3513) 30 mm Fasad MDF, 2 st	1 582	1 656	1 713	2 538	1 901	1 901
* Upcharge for veneer edging on laminate		104	104			
* Upcharge for veneer edging on linoleum. Note: Only oak/ash nature and white pigmented. Not possible on stained tables.				104		
Option: cable lid 980						

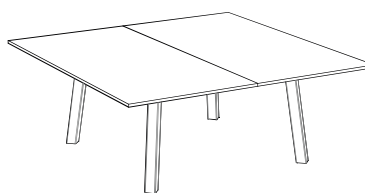
VX Project 4xlegs with steel frame (exck tabke top):	White (31) Black (37)	Optional colours	Oak (03) Ash (06)	Stain / White pigm
Table height 73 cm	1 366	1 523	1 366	1 445
Table height 90 cm	1 513	1 670	1 513	1 592
Upcharge for wooden legs with round profile			92	92

VX Project round table tops



Sizes (mm):
Ø 1500, 1600, 1800, 2000, 2400.

VX Project square table tops



Sizes (mm):
1500X1500, 1600x1600, 1800x1800, 2000x2000, 2400x2400.


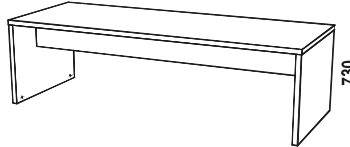
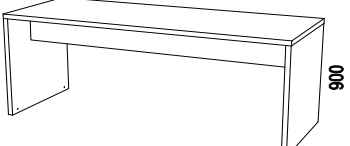
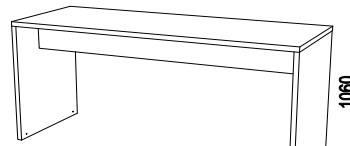
Illustration	Description	Article number	Material	EUR																								
<p>Nomono Conference Design: Fredrik Mattson</p>																												
	<p>Nomono CONFERENCE TABLE</p> <ul style="list-style-type: none"> Nomono conference is made of 38 mm particle board Radius 90 and straight edges with matching pp-list Material: <table border="0" data-bbox="526 369 1173 481"> <tr> <td>White HPL (31)</td> <td>Vitpigment (30)</td> <td>Burgundy stained ash (C8)</td> </tr> <tr> <td>Oak (03)</td> <td>White ash (10)</td> <td>Conifer stained ash (D3)</td> </tr> <tr> <td>Ash (06)</td> <td>Black ash (86)</td> <td>Smokey Blue stained ash (D4)</td> </tr> <tr> <td></td> <td>Dark ash (76)</td> <td></td> </tr> </table> Distance from edge of desk to middle frame: <ul style="list-style-type: none"> Width 1100 = 420 mm Width 1000 = 370 mm Width 900 = 320 mm Width 800 = 270 mm Width 700 = 220 mm Cable box Bibox and Powerdot PD14 och PD61 fits Nomono Conference. For more product information, please see www.horreds.se 				White HPL (31)	Vitpigment (30)	Burgundy stained ash (C8)	Oak (03)	White ash (10)	Conifer stained ash (D3)	Ash (06)	Black ash (86)	Smokey Blue stained ash (D4)		Dark ash (76)													
White HPL (31)	Vitpigment (30)	Burgundy stained ash (C8)																										
Oak (03)	White ash (10)	Conifer stained ash (D3)																										
Ash (06)	Black ash (86)	Smokey Blue stained ash (D4)																										
	Dark ash (76)																											
	<p>Nomono conference in height 720 mm Available lengths: 2400, 2200, 2000, 1800 och 1600 mm.</p> <table border="0" data-bbox="518 828 1452 1164"> <tr> <td>Width 800 or 900 mm</td> <td>White HPL</td> <td>2 433</td> </tr> <tr> <td></td> <td>Oak / Ash</td> <td>2 915</td> </tr> <tr> <td></td> <td>Stained Ash</td> <td>2 915</td> </tr> <tr> <td></td> <td>White Oak / Ash</td> <td>2 915</td> </tr> <tr> <td>Width 1000 or 1100 mm</td> <td>White HPL</td> <td>2 975</td> </tr> <tr> <td></td> <td>Oak / Ash</td> <td>3 457</td> </tr> <tr> <td></td> <td>Stained Ash</td> <td>3 457</td> </tr> <tr> <td></td> <td>White Oak / Ash</td> <td>3 457</td> </tr> </table>				Width 800 or 900 mm	White HPL	2 433		Oak / Ash	2 915		Stained Ash	2 915		White Oak / Ash	2 915	Width 1000 or 1100 mm	White HPL	2 975		Oak / Ash	3 457		Stained Ash	3 457		White Oak / Ash	3 457
Width 800 or 900 mm	White HPL	2 433																										
	Oak / Ash	2 915																										
	Stained Ash	2 915																										
	White Oak / Ash	2 915																										
Width 1000 or 1100 mm	White HPL	2 975																										
	Oak / Ash	3 457																										
	Stained Ash	3 457																										
	White Oak / Ash	3 457																										
	<p>Nomono conference in height 900 mm Available lengths: 2400, 2200, 2000, 1800 och 1600 mm.</p> <table border="0" data-bbox="518 1254 1452 1601"> <tr> <td>Width 700, 800 or 900 mm</td> <td>White HPL</td> <td>2 433</td> </tr> <tr> <td></td> <td>Oak / Ash</td> <td>2 915</td> </tr> <tr> <td></td> <td>Stained Ash</td> <td>2 915</td> </tr> <tr> <td></td> <td>White Oak / Ash</td> <td>2 915</td> </tr> <tr> <td>Width 1000 or 1100 mm</td> <td>White HPL</td> <td>2 975</td> </tr> <tr> <td></td> <td>Oak / Ash</td> <td>3 457</td> </tr> <tr> <td></td> <td>Stained Ash</td> <td>3 457</td> </tr> <tr> <td></td> <td>White Oak / Ash</td> <td>3 457</td> </tr> </table>				Width 700, 800 or 900 mm	White HPL	2 433		Oak / Ash	2 915		Stained Ash	2 915		White Oak / Ash	2 915	Width 1000 or 1100 mm	White HPL	2 975		Oak / Ash	3 457		Stained Ash	3 457		White Oak / Ash	3 457
Width 700, 800 or 900 mm	White HPL	2 433																										
	Oak / Ash	2 915																										
	Stained Ash	2 915																										
	White Oak / Ash	2 915																										
Width 1000 or 1100 mm	White HPL	2 975																										
	Oak / Ash	3 457																										
	Stained Ash	3 457																										
	White Oak / Ash	3 457																										
	<p>Nomono conference in height 1060 mm Available lengths: 2400, 2200, 2000, 1800 och 1600 mm.</p> <table border="0" data-bbox="518 1691 1452 2038"> <tr> <td>Width 700, 800 or 900 mm</td> <td>White HPL</td> <td>2 433</td> </tr> <tr> <td></td> <td>Oak / Ash</td> <td>2 915</td> </tr> <tr> <td></td> <td>Stained Ash</td> <td>2 915</td> </tr> <tr> <td></td> <td>White Oak / Ash</td> <td>2 915</td> </tr> <tr> <td>Width 1000 or 1100 mm</td> <td>White HPL</td> <td>2 975</td> </tr> <tr> <td></td> <td>Oak / Ash</td> <td>3 457</td> </tr> <tr> <td></td> <td>Stained Ash</td> <td>3 457</td> </tr> <tr> <td></td> <td>White Oak / Ash</td> <td>3 457</td> </tr> </table>				Width 700, 800 or 900 mm	White HPL	2 433		Oak / Ash	2 915		Stained Ash	2 915		White Oak / Ash	2 915	Width 1000 or 1100 mm	White HPL	2 975		Oak / Ash	3 457		Stained Ash	3 457		White Oak / Ash	3 457
Width 700, 800 or 900 mm	White HPL	2 433																										
	Oak / Ash	2 915																										
	Stained Ash	2 915																										
	White Oak / Ash	2 915																										
Width 1000 or 1100 mm	White HPL	2 975																										
	Oak / Ash	3 457																										
	Stained Ash	3 457																										
	White Oak / Ash	3 457																										



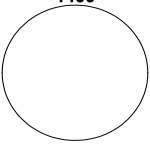
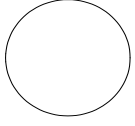
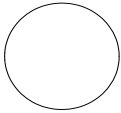
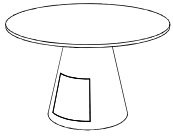
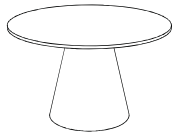
Illustration	Description	Article number	Material	EUR
Tin Design: Morgan Rudberg och Lars Pettersson 				
 <p>Tin CONFERENCE TABLE</p> <ul style="list-style-type: none"> • Desk tops in 19 mm MDF with matching list. • Rectangular table tops: radius 0. • Leg base of perforated, rolled steel sheet. White (31) or black (37). • Legs base with serice hatch for easy handling of cables. • Other RAL colours against quotation • Two desk heights: 73 and 90 cm. • Option: VX cable lid 06470 fits Tin. • For additional product information please see www.horreds.se <p>Material: White HPL = closest NCS S0502-Y Optional HPL: Light grey, Medium grey, Anthracite and Black Linoleum: 4132 Ash, 4154 Burgundy, 4166 Charcoal, 4172 Mauve, 4174 Conifer, 4175 Pebble, 4176 Mushroom, 4177 Vapour, 4179 Smokey Blue, 4184 Olive. Veneer group 1: Oak (03) and Ash (06) Veneer group 2: Black stained ash (86) / Dark stained ash (76), White pigm.oak(30), White pigm.ash (10) , Burgundy stained ash (C8), Conifer stained ash (D3), Smokey Blue stained ash (D4).</p>				
Round table tops:				
 <p>1400</p>	Table top diameter 1400 mm, excluding stand and cable lid	47 31 1603174	White HPL	1 211
		47 39 1603174	Opt. HPL	
		47 88 1603174	Linoleum	1 480
		47 xx 1603174	Veneer 1	1 722
		47 xx 1603174	Veneer 2	1 722
 <p>1200</p>	Table top diameter 1200 mm, excluding stand and cable lid	47 31 1603175	White HPL	491
		47 39 1603175	Opt. HPL	601
		47 88 1603175	Linoleum	695
		47 xx 1603175	Veneer 1	555
		47 xx 1603175	Veneer 2	555
 <p>1100</p>	Table top diameter 1100 mm, excluding stand and cable lid	47 31 1603300	White HPL	491
		47 39 1603300	Opt. HPL	601
		47 88 1603300	Linoleum	695
		47 xx 1603300	Veneer 1	555
		47 xx 1603300	Veneer 2	555
Stands for round tops (excl table top):				
	Tin stand with hatch.. Fits round table top (order separately) Desk heigh 73 cm	47 xx 73R-1	White/black	2 790
	Like above but desk height 90 cm	47 xx 90R-1	White/black	2 907
	Tin stand without hatch.. Fits round table top (order separately) Desk heigh 73 cm	47 xx 73R	White/black	2 479
	Like above but desk height 90 cm	47 xx 90R	White/black	2 596



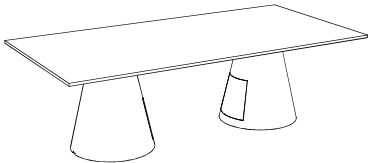
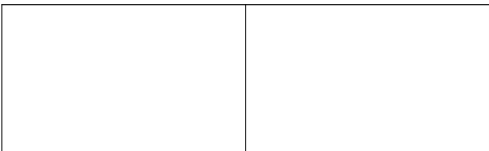

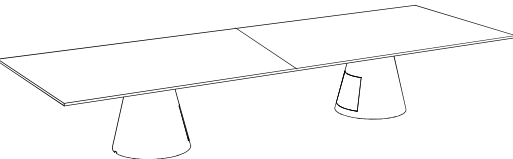
Illustration	Description	Article number	Material	EUR
Rectangular table tops:				
	Table top 2400x1400 mm excluding stand and cable lid	47 31 16007713	White HPL	1 211
		47 39 16007713	Opt. HPL	
		47 88 16007713	Linoleum	1 480
		47 xx 16007713	Veneer 1	1 722
		47 xx 16007713	Veneer 2	1 722
	Table top 2400x1200 mm excluding stand and cable lid	47 31 1603439	White HPL	731
		47 39 1603439	Opt. HPL	789
		47 88 1603439	Linoleum	1 171
		47 xx 1603439	Veneer 1	843
		47 xx 1603439	Veneer 2	843
Stand for rectangular tops:				
	Tin stand (x2) with hatches. Fits rectangular tops (order separately) Desk height 73 cm	47 xx 73LLDD-1	White/black	6 066
	Like above but desk height 90 cm	47 xx 90LLDD-1	White/black	6 298
2-pieces rectangular table tops:				
	Table top 4800x1400 (2 pieces) excluding stand and cable lid	47 31 16xxxxx	White HPL	2 536
		47 39 16xxxxx	Opt. HPL	
		47 88 160xxxx	Linoleum	3 073
		47 xx 160xxxx	Veneer 1	3 558
		47 xx 160xxxx	Veneer 2	3 558
	Table top 4800x1200 (2 pieces) excluding stand and cable lid	47 31 1603440	White HPL	1 576
		47 39 1603440	Opt. HPL	1 634
		47 88 1603440	Linoleum	2 456
		47 xx 1603440	Veneer 1	1 799
		47 xx 1603440	Veneer 2	1 799
Stand for 2-piece rectangular tops:				
	Tin stand (x2) with hatches. Fits 2-piece rectangular tops (order separately). Desk height 73 cm	47 xx 73LLDD-1	White/black	6 563
	Like above but desk height 90 cm	47 xx 90LLDD-1	White/black	6 796

Illustration	Description	Article number	Material	EUR
CABLE SLOTS TO MEETING TABLES				
Cable entries and Hub suitable for: <ul style="list-style-type: none"> • VX Conference • VX Project 				
Cable lid on hinges				
	Cable lid for conference table, chamfered edge, Length 600 mm. Incl. cable tray (white/black) Size of cable entry: 600x170 mm, with 2 flaps each 596x75 mm. Power socket to be ordered separately. <i>Not to tables in white direct laminate!</i>	34 31 04967 34 xx 04967 34 xx 04967	White HPL. Opt.HPL Linoleum	455 455 455
	Cable lid for conference table, chamfered edge, Length 600 mm. Incl. cable tray (white/black) Size of cable entry: 600x170 mm, with 2 flaps each 575x72 mm. Power socket to be ordered separately. Always produced in same material as the table top with matching of veneer.	35 xx 980x	Veneer	607
		Axessline socket with 5xpower, 2xUSB-laddare, 1xHDMI, 4xData, och 2xUSB. 2 m cable.	93 5- T5UD-15	
	Power socket 3-ways, 3 m cable	93 6- E3V30B	Black	27
	Power socket 6-ways, 3 m cable	93 6- E6V30B	Black	32
	Hub • Screens for Hub, see page 106.			
	Hub in Forbo linoleum, with 4 x power (PM50) and 4 x USB -C charger (PM52). Prepared for lamp Sempé and Hub desk screens	34 XX 08350	Linoleum	1 101
	Hub in steel, with 4 x power (PM50) and 4 x USB -C charger (PM52). White (RAL9016) alt.black (RAL9005) structure. Prepared for lamp Sempé and Hub desk screens	34 31 09502 34 37 09502	White Black	1 009 1 009
	Cable tray conference 670x200x140 mm.	34 31 04381 34 37 04381	White Black	157 157
	Lampa Mushroom for mounting in HUB. Lamp for mounting in table top, including drilling Powder coated in black fine structure. Incl lightsource: LED E27 2700K 380lm CRI<80 (2pcs) Pull switch. Diameter 390mm, height 400 mm.	34 37 P380 34 37 P380B	Black Black	844 954





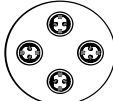


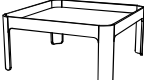
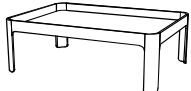
Illustration	Description	Article number	Material	EUR
	<p>MIT Design: Thomas Bernstrand och Stefan Borselius</p> <p>Accessoeriet suitable for:</p> <ul style="list-style-type: none"> • VX Konferens • VX Projekt Konferens • Tin 			
	<p>Socket strip single with 4 x power (PM50)</p> <p>348x108 mm</p>	<p>74 31 08179-4</p> <p>74 37 08179-4</p>	<p>Vit</p> <p>Svart</p>	<p>259</p> <p>259</p>
	<p>Socket strip double with 4 x power (PM50)</p> <p>188x188 mm</p>	<p>74 31 08182-4</p> <p>74 37 08182-4</p>	<p>Vit</p> <p>Svart</p>	<p>259</p> <p>259</p>
	<p>Socket strip double with 6 x power (PM50)</p> <p>268x188 mm</p>	<p>74 31 08182-6</p> <p>74 37 08182-6</p>	<p>Vit</p> <p>Svart</p>	<p>365</p> <p>365</p>
	<p>Socket strip round with 4 x power (PM50)</p> <p>ø 245 mm</p>	<p>74 31 08208-4</p> <p>74 37 08208-4</p>	<p>Vit</p> <p>Svart</p>	<p>258</p> <p>258</p>
	<p>Socket strip round with 6 x power (PM50)</p> <p>ø 245 mm</p>	<p>74 31 08208-6</p> <p>74 37 08208-6</p>	<p>Vit</p> <p>Svart</p>	<p>348</p> <p>348</p>
	<p>Upcharge for alternative powerdot with double USB-C PD charger (PM52) <u>Note: price for 1 piece</u></p>			55
	<p>Accessories tray for socket strip 08179-4</p> <p>358x118x100 mm</p>	<p>74 31 08175-4</p> <p>74 37 08175-4</p>	<p>White</p> <p>Black</p>	<p>544</p> <p>544</p>
	<p>Accessory tray for socket strip 08124-4</p> <p>198x198x100 mm</p>	<p>74 31 08180-4</p> <p>74 37 08180-4</p>	<p>White</p> <p>Black</p>	<p>544</p> <p>544</p>
	<p>Accessory tray for socket strip 08124-6</p> <p>278x198x100 mm</p>	<p>74 31 08180-6</p> <p>74 37 08180-6</p>	<p>White</p> <p>Black</p>	<p>617</p> <p>617</p>


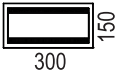






Illustration	Description	Article number	Material	EUR
Bibox (Also fits Nomono conference)				
	Bi-Box Large, openable cover and cable tray in one, including predrilling cost.	72 10 01-1	White	518
		72 10 01-2	Black	518
	Power Inlay for Bi-box Large: 4xPower, 4xData and 4xUSB.	72 10 04		330
	Bi-Box Small, openable cover and cable tray in one, including predrilling cost.	72 10 00-1	White	285
		72 10 00-2	Black	285
	Power Inlay for Bi-box Small: 3xPower and 2xData.	72 10 02		145
Cable lid (Also fits Tin)				
	VX cable lid, diameter 260 mm. Incl cable tray (black or white) with PD10 power + magic hole), The cable lid is in same material as the table top	34 xxxx 06470		489
	Add.price for alternative powers: PD12 (power, computer, USB-charger)		add. / port	100
	PD13 (power HDMI, USB) Note: add prices are per each power.		add. / port	136
Powerdots (also fits Tin and Nomono conference)				
	Powerdot cable entry 80 mm 1 x el + 4 x Magic Holes	935 -PD10	Black	66
		935 -PD10W	White	66
	Powerdot cable entry 80 mm. 1 power, 2 USB-C charger (2x30W), 1 magic hole ø8 mm.	935 -PD17	Black	190
		935 -PD17W	White	190
	Powerdot cable entry 60 mm. 1 power, 1 USB-laddare.	935 -PM61	Black	103
		935 -PM61W	White	103
	Powerdot cable entry 60 mm. 1 power, 1 USB-IC PD charger	935 -PM62	Black	144
		935 -PM62W	White	144
	Cordless charger ø 60 mm.	935 -QI60	Black	176
		935 -QI60W	White	176
	Cable entry customised	HÅLT.2		121
	Kable sock ø 20mm in braided textile. Length 1500 mm. With zipper...	32 54 000109	Black	39
		32 54 000101	White	39
	Cable pipe in textile. Length1500 mm	29 31 1500	Black	119
		29 37 1500	White	119


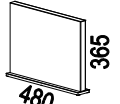
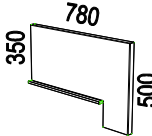
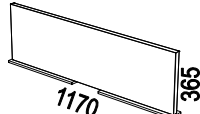
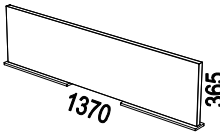

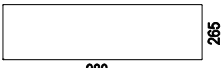
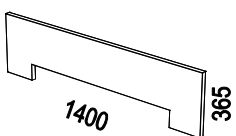
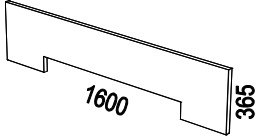
Illustration	Description	Article number	Material	EUR	
<p>Screens</p> <ul style="list-style-type: none"> • Thickness 35 mm, of which 30 mm in sound absorbing material • For other fabrics; please ask for quotation. 					
<p>Price group 1: Camira: Cara, Carlow Gabriel: Event Screen, Hush</p>		<p>Price group 2: Camira: Blazer Lite Gabriel: Soul, Soul Mel, Twist, Twist Mel, Focus Melange Screen, Cura Screen Kvadrat: Hint</p>		<p>Price group 3: Camira: Blazer, Main Line Flax Gabriel: Step Melange Screen Kvadrat: Remix, Remix Screen, Floyd Scr.</p>	
<p>Free standing screens</p>					
	<p>Sound absorbing side screen 480x365x35 mm with foot in wood (ø 250mm) Foot available in hard vaxed oiled oak and stained ash.</p>	<p>34 xx 09147-x</p>	<p>PG 1 PG 2 PG 3</p>	<p>371 397 422</p>	
	<p>Sound absorbing side screen 480x365x35 mm Including foot in laquered steel. Choose colour of the foot; white or black.</p>	<p>34 xx 03374-x</p>	<p>PG 1 PG 2 PG 3</p>	<p>292 310 338</p>	
	<p>Sound absorbing side screen 780x350x35 mm. Including foot in laquered steel. Choose colour of the foot; white or black.</p>	<p>34 xx 06360-x</p>	<p>PG 1 PG 2 PG 3</p>	<p>362 398 434</p>	
	<p>Sound absorbing side screen 1170x365x35 mm Including foot in laquered steel. Choose colour of the foot; white or black.</p>	<p>34 xx 04360-x</p>	<p>PG 1 PG 2 PG 3</p>	<p>550 589 643</p>	
	<p>Sound absorbing side screen 1370x365x35 mm Including foot in laquered steel. Choose colour of the foot; white or black.</p>	<p>34 xx 04361-x</p>	<p>PG 1 PG 2 PG 3</p>	<p>566 610 665</p>	
	<p>Pen tray for side screen on foot.</p>	<p>34 31 03357 34 37 03357</p>	<p>White Black</p>	<p>68 68</p>	
<p>Screens for Hub</p>					
	<p>Sound absorbing desk screen 980x265x35 mm, for mounting in Hub. Incl white or black fittings.</p>	<p>34 xx 03375-x</p>	<p>PG 1 PG 2 PG 3</p>	<p>352 377 411</p>	
	<p>Sound absorbing desk screen 1400x365x35 mm, for mounting in Hub. Incl white or black fittings.</p>	<p>34 xx 04358-x</p>	<p>PG 1 PG 2 PG 3</p>	<p>402 428 467</p>	
	<p>Sound absorbing desk screen 1600x365x35 mm, for mounting in Hub. Incl white or black fittings.</p>	<p>34 xx 04359-x</p>	<p>PG 1 PG 2 PG 3</p>	<p>420 451 492</p>	


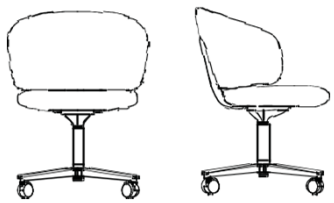
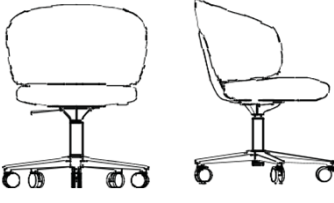
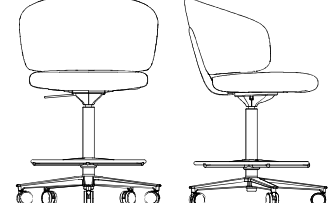
Illustration	Description	Article number	Price group	EUR
Prime Design: Fredrik Mattson				
	<p>Prime STOL</p> <ul style="list-style-type: none"> Fully upholstered conference or meeting chair. Seat of molded HR foam on plywood, molded back with metal insert. CMHR foam for an extra charge € 68. 4-wing aluminum stand with castors, rotatable, with damping. 5-wing aluminum stand with castors, height adjustable. Castors with polyurethane tread, suitable for all floors. For more product information see www.horreds.se <p>Stand colours: Black RAL 9005 (37) - standard Optional colours - see page 164 - at extra cost Polished top side (13) - at extra cost</p>			
 <p>Seat height: 46cm Width: 60cm Height: 82cm Depth: 57cm</p>	<p>4-wing black aluminium stand with castors. Fixed height, tilt, swivel, damping.</p> <p>*NB Leather: min quantity 2 pcs in same colour</p> <p><i>Upcharge optional colours (black castors+tilt)</i> <i>Upcharge polished stand (black details)</i> <i>Upcharge for interval braked castors</i></p>	<p>50 xx 20A-xxx</p> <p>50 yy 20A-xxx</p> <p>50 13 20A-xxx</p> <p>50 xx 22A-xxx</p>	<p>PG 1 PG 2 PG 3 PG 4 PG 5 PG 6 PG 7 Leather*</p>	<p>1 023 1 065 1 110 1 156 1 209 1 281 1 382 1 502</p> <p>78 29 27</p>
 <p>Sea height: 43-55cm Width: 60cm Height: 79-91cm Depth: 60 cm</p>	<p>5-wing black aluminium stand with castors. Height adjustable 43-55cm, tilt, swivel.</p> <p>*NB Leather: min quantity 2 pcs in same colour</p> <p><i>Upcharge optional colours (black castors+tilt)</i> <i>Upcharge polished stand (black details)</i> <i>Upcharge for interval braked castors</i></p>	<p>50 xx 10A-xxx</p> <p>50 yy 10A-xxx</p> <p>50 13 10A-xxx</p> <p>50 xx 12A-xxx</p>	<p>PG 1 PG 2 PG 3 PG 4 PG 5 PG 6 PG 7 Leather*</p>	<p>1 040 1 083 1 128 1 173 1 226 1 298 1 399 1 519</p> <p>78 29 27</p>
 <p>Seat height: 60-80cm Width: 60cm Height: 79-91cm Depth: 60 cm</p>	<p>High 5-wing black aluminium stand with castors. Height adjustable 60-80cm, tilt, swivel and interval braked castors. Adjustable footrest black/chrome</p> <p>*NB Leather: min quantity 2 pcs in same colour</p>	<p>50 37 30A-xxx</p>	<p>PG 1 PG 2 PG 3 PG 4 PG 5 PG 6 PG 7 Leather*</p>	<p>1 218 1 260 1 306 1 351 1 404 1 476 1 577 1 697</p>

Illustration	Description	Article number	Price	EUR
Grand Design: Thomas Bernstrand and Stefan Borselius				
	<p>Grand CHAIR</p> <ul style="list-style-type: none"> • Upholstered confence or meeting chair. • Seat of HR-foam on plywood, molded back with metal inserts. • Upcharge for CHMR-foam: € 60. • Arm rest in solid oak / ash or black leather. • Leather armchairs always have leatherclad armrests as standard. • Can also be ordered without armrests. • 5-wing aluminum stand with castors. Powder coated (black and white). • 4-wing aluminum stand with or without castors. Powder coated (black and white). • Lounge model with foot plate and autoreturn. Powder coated (black and white). • Castors with polyurethane roller track, suitable for all floors. • Price for leather chairs in less than 2 pieces; against quotation. • For more product information, see www.horreds.com 			
	<p><u>Stands:</u> WhiteRAL 9016 (31) Black RAL 9005 (37)</p>	<p><u>Armrests:</u> Oak (03), Ash (06), Black ash (86), Dark ash (76), White oak (30), White ash (10)</p>		
<p>5-WINGED WITH CASTORS</p> <ul style="list-style-type: none"> • Seat height 44-49 cm • Height of low back 82-87 cm / high back 104-109 cm • Width 67 cm • Height armrests 63-69 cm • Depth 65 cm 				
	<p>Chair with low back and armrests in solid oak / ash (nature/white pigm../dark stained). 5-wing stand, adjustable height 44-49 cm, tilt. Black (37) White (31)</p> <p>*Note:Leather minimum 2 pcs in same color, always matching leather on armrests</p>	<p>71 xx xx 11M-xxx</p>	<p>PG 1 PG 2 PG 3 PG 4 PG 5 PG 6 PG 7 Leather*</p>	<p>1 309 1 346 1 387 1 428 1 474 1 525 1 597 1 674</p>
	<p>Upcharge armrests in black leather</p>	<p>71 xx 97 11M-xxx</p>		<p>41</p>
	<p>Upcharge for interval braked castors</p>	<p>71 xx xx 12M-xxx</p>		<p>27</p>
	<p>Deduction for chair without armrests</p>	<p>71 xx 00 11M-xxx</p>		<p>-116</p>
	<p>Chair with high back and armrests in solid oak / ash (nature/white pigm../dark stained). 5-wing stand, adjustable height 44-49 cm, tilt. Black (37) White (31)</p> <p>*Note:Leather minimum 2 pcs in same color, always matching leather on armrests</p>	<p>71 xx xx 11H-xxx</p>	<p>PG 1 PG 2 PG 3 PG 4 PG 5 PG 6 PG 7 Leather*</p>	<p>1 504 1 550 1 601 1 653 1 710 1 773 1 864 1 971</p>
	<p>Upcharge armrests in black leather</p>	<p>71 xx 97 11H-xxx</p>		<p>41</p>
	<p>Upcharge for interval braked castors</p>	<p>71 xx xx 12H-xxx</p>		<p>27</p>
	<p>Deduction for chair without armrests</p>	<p>71 xx 00 11H-xxx</p>		<p>-116</p>

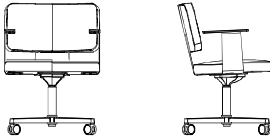
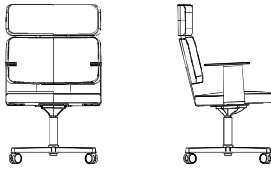

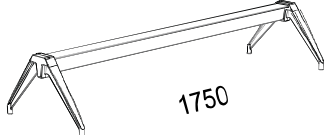
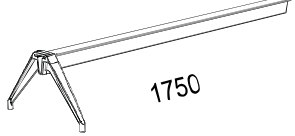
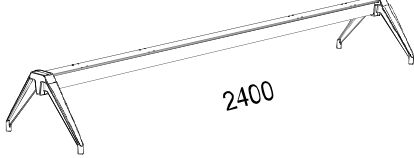
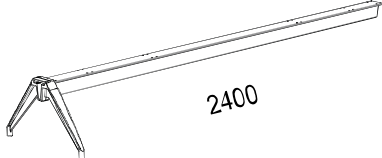
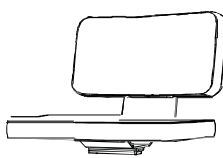


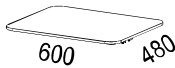
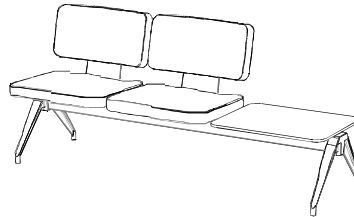
Illustration	Description	Article number	Price	EUR	
<p>4-WING WITH CASTORS</p> <ul style="list-style-type: none"> • Seat height 46 cm • Height of low back 84 cm / high back 106 cm •Width including armrest 60 cm / exclusive armrest 59 cm • Height armrest 67cm • Depth 59 cm 					
	<p>Chair with low back and armrests in solid oak / ash (nature/white pigm../dark stained). 4-wing stand with castors, fixed height 46 cm. Tilt. Black (37) White (31)</p>	71 xx xx 20M-xxx	PG 1 PG 2 PG 3 PG 4 PG 5 PG 6 PG 7 Leather*	1 262 1 298 1 339 1 381 1 427 1 477 1 550 1 626	
	<p>*Note:Leather minimum 2 pcs in same color, always matching leather on armrests</p>				
	<p>Upcharge armrests in black leather</p>	71 xx 97 20M-xxx			41
	<p>Upcharge for interval braked castors</p>	71 xx xx 22M-xxx			27
	<p>Deduction for chair without armrests</p>	71 xx 00 20M-xxx			-116
	<p>Chair with high back and armrests in solid oak / ash (nature/white pigm../dark stained). 4-wing stand with castors, fixed height 46 cm. Tilt. Black (37) White (31)</p>	71 xx xx 20H-xxx	PG 1 PG 2 PG 3 PG 4 PG 5 PG 6 PG 7 Leather*	1 458 1 503 1 555 1 606 1 663 1 727 1 818 1 924	
	<p>*Note:Leather minimum 2 pcs in same color, always matching leather on armrests</p>				
	<p>Upcharge armrests in black leather</p>	71 xx 97 20H-xxx			41
	<p>Upcharge for interval braked castors</p>	71 xx xx 22H-xxx			27
	<p>Deduction for chair without armrests</p>	71 xx 00 20H-xxx			-116

Illustration	Description	Article number	Price group	EUR
Grand Balk Design: Thomas Bernstrand och Stefan Borselius				
	<p>GRAND BALK Sofa</p> <ul style="list-style-type: none"> Fully upholstered buildable beam sofa in seat height 46 cm. Beam and legs in recycled aluminum, powder coated. Seat module of molded HR raom on plywood, molded back with metal insert. CMHR foam for an additional € 60. Arms upport in solid oak / ash. Black leather for an additional € 41. Armchairs in leather always have leather-covered handles in same colour. For mor product information see www.horreds.se 			
	<p>Beam, freestanding, for 3 modules Length 1750mm</p>	71 37 1750	Black	1 043
	<p>Beam, for coupling, for 3 modules Lengt 1750mm, with 1 leg. <i>To be used together with freestanding beam</i></p>	71 37 1750K	Black	924
	<p>Beam, freestanding, for 4 modules Length 2400mm</p>	71 37 2400	Black	1 215
	<p>Beam, for coupling, for 4 modules Lengt 2400mm, with 1 leg. <i>To be used together with freestanding beam</i></p>	71 37 2400K	Black	1 096
	<p>Seating module with black back plate. Incl. clamp to beam.</p> <ul style="list-style-type: none"> Width 59cm Depth 59cm Back height 82cm (above floorv) <p>*NB:Leather minimum 2 pcs in same colour,</p>	71 37 00M-x	PG 1 PG 2 PG 3 PG 4 PG 5 PG 6 PG 7 Leather*	788 828 868 907 953 1 014 1 106 1 182
	<p>Upcharge for armsupport right / left Note: Price per piece Black bracket with armsupport in solid oak/ash (clear coated or stained in standard stains.</p>	71 xx37 08129H 71 xx37 08129V	black/veneer black/veneer	58 58
	<p>Table top 480x300mm, incl clamp, corresponds to 0,5 module. With edging and chamfered edge.</p>	71 xx37 -300	Veneer Laminate Linoleum	206 206 206
	<p>Table top 480x600mm, incl clamp, corresponds to 1 module. With edging and chamfered edge.</p>	71 xx37 -600	Veneer Laminate Linoleum	355 355 355

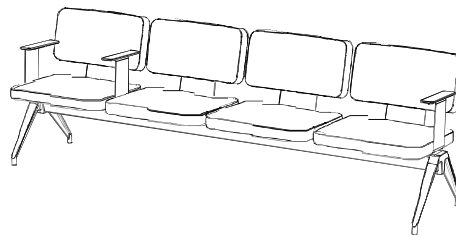
	Electricity / charging in table top - required 2 pcs / table.				
	1 x Power	935	PM50	Black	63
	2x USB-C charger	935	PM52	Black	144
	Kabelstrumpa i textil 1500mm	29	37	1500	Black 119

Price example 1:



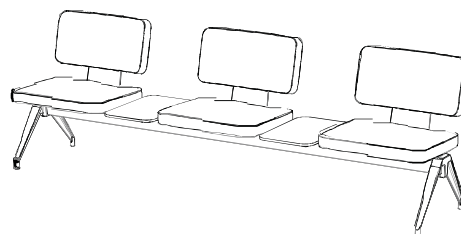
Freestanding beam for 3 modules	art nr 71 37 1750	Material	Pieces	Price/pce	Total
Seating module	art 71 37 00M-x	Black	1	1 043	1 043
Table top 480x600 mm, incl clamp	art 71 06 37-600	PG 1	2	788	1 576
		Ash	1	355	355
					2 974

Price example 2:



Freestanding beam for 4 modules	art nr 71 37 2400	Material	Pieces	Price/pce	Total
Seating module	art 71 37 00M-x	Black	1	1 215	1 215
Armrest right	art 71 37 06 08129H	PG 1	4	788	3 152
Armrest left	art 71 37 06 08129V	Black/ash	1	58	58
		Black/ash	2	58	116
					4 367

Price example 3:



Freestanding beam for 4 modules	art nr 71 37 2400	Material	Pieces	Price/pce	Total
Seating module	art 71 37 00M-x	Svart	1	1 215	1 215
Table top 480x300 mm, incl clamp	art 71 06 37-300	Tyg PG 1	3	788	2 364
		Ask	2	206	412
					3 991

Corner setups / other lengths? Please contact us for quotation.

Glove Design: Fredrik Mattson**Glove Medium and High**

- Upholstered conference/meeting chair in high or medium design.
- Molded cold foam (HR) with metal frame. Upcharge for CMHR foam; € 36.
- Castors with polyurethane roller conveyor, suitable for all floors.
- Selected stands are available in optional colours, others on request. See page 164 for more info.
- For fabric selection; see Fabrics - Price Groups. If other fabric desired; contact us for a quote.
- Channel-sewn upholstery Bolster as an option in price group 1-7 excl. artificial leather.
- 6 different stands:



5-wing aluminum stand in black, optional colours or polished. Tilt, adjustable height 43-53cm.



4-wing aluminum stand with castors and tilt. Black, optional colours or polished.



4-wing aluminum stand with sliding feet and tilt. Black alt. white powder coating or polished aluminum.



5-wing steel stand in black and optional colour. Tilt, fixed height 45cm. Option: adjust-43-52cm.



4-legged steel stand in black alt. white powder coating or chrome.



4-legged wooden stand in oak alt. ash.

Glove Bolster Cover

Do you have a Glove that needs to be renewed?
Glove Bolster Cover is now available, a cover for Glove High and Medium.
The bolster cover not only gives Glove a new life, but also a new character.
A figure-hugging, looser and slightly more comfortable sitting experience.



- For more product information, see www.horreds.se


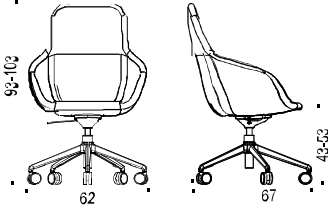
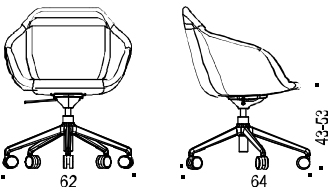
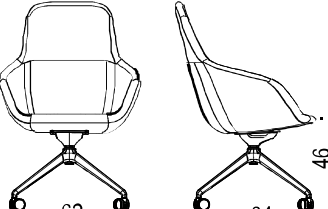
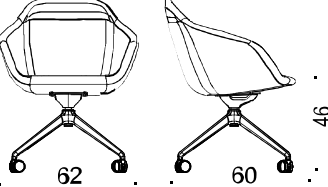
Illustration	Description	Article number	Price group	EUR
Glove Design: Fredrik Mattson				
Glove CHAIR				
	<p>Chair, high back. 5-wing aluminum base, with tilt, rotatable, adjustable height 43-53 cm. Black base (37).</p> <p>*NB: Leather min. 2 chairs in same colour <i>Upcharge for Bolster upholstery pg 1-7**</i> <i>Upcharge for interval braked castors</i> <i>Upcharge polished stand (black tilt)</i> <i>Upcharge for swing with adj. hardness</i> <i>Upcharge opt.colours stand (black castors/tilt)</i></p>	<p>51 37 51H01-xxx</p> <p>51 xx 51H0B-xxx</p> <p>51 xx 51H11-xxx</p> <p>51 13 51H01-xxx</p> <p>51 xx 52H01-xxx</p> <p>51 yy 51H01-xxx</p>	<p>PG 1</p> <p>PG 2</p> <p>PG 3</p> <p>PG 4</p> <p>PG 5</p> <p>PG 6</p> <p>PG 7</p> <p>Leather*</p>	<p>1 058</p> <p>1 107</p> <p>1 162</p> <p>1 217</p> <p>1 279</p> <p>1 347</p> <p>1 445</p> <p>1 501</p> <p>139</p> <p>27</p> <p>55</p> <p>96</p> <p>78</p>
	<p>Chair, medium back. 5-wing aluminum stand, with tilt, rotatable, adjustable height 43-53 cm. Blak base (37).</p> <p>*NB: Leather min. 2 chairs in same colour <i>Upcharge for Bolster upholstery pg 1-7**</i> <i>Upcharge for interval braked castors</i> <i>Upcharge polished stand (black tilt)</i> <i>Upcharge for swing with adj. hardness</i> <i>Upcharge opt.colours stand (black castors/tilt)</i></p>	<p>51 37 51M01-xxx</p> <p>51 xx 51M0B-xxx</p> <p>51 xx 51M11-xxx</p> <p>51 13 51M01-xxx</p> <p>51 xx 52M01-xxx</p> <p>51 yy 51M01-xxx</p>	<p>PG 1</p> <p>PG 2</p> <p>PG 3</p> <p>PG 4</p> <p>PG 5</p> <p>PG 6</p> <p>PG 7</p> <p>Leather*</p>	<p>979</p> <p>1 021</p> <p>1 069</p> <p>1 117</p> <p>1 171</p> <p>1 230</p> <p>1 314</p> <p>1 440</p> <p>139</p> <p>27</p> <p>55</p> <p>96</p> <p>78</p>
	<p>Chair, high back. 4-winged aluminium base with castors and tilt, turnable. Blak base (37).</p> <p>*NB: Leather min. 2 chairs in same colour <i>Upcharge for Bolster upholstery pg 1-7**</i> <i>Upcharge polished stand (black tilt)</i> <i>Upcharge opt.colours stand (black castors/tilt)</i></p>	<p>51 37 31H01-xxx</p> <p>51 xx 31H0B-xxx</p> <p>51 13 31H01-xxx</p> <p>51 yy 31H01-xxx</p>	<p>PG 1</p> <p>PG 2</p> <p>PG 3</p> <p>PG 4</p> <p>PG 5</p> <p>PG 6</p> <p>PG 7</p> <p>Leather*</p>	<p>1 013</p> <p>1 062</p> <p>1 117</p> <p>1 172</p> <p>1 234</p> <p>1 302</p> <p>1 400</p> <p>1 456</p> <p>139</p> <p>42</p> <p>63</p>
	<p>Chair, medium back. 4-winged aluminium base with castors and tilt, turnable. Blak base (37).</p> <p>*NB: Leather min. 2 chairs in same colour <i>Upcharge for Bolster upholstery pg 1-7**</i> <i>Upcharge polished stand (black tilt)</i> <i>Upcharge opt.colours stand (black castors/tilt)</i></p>	<p>51 37 31M01-xxx</p> <p>51 xx 31M0B-xxx</p> <p>51 13 31M01-xxx</p> <p>51 yy 31M01-xxx</p>	<p>PG 1</p> <p>PG 2</p> <p>PG 3</p> <p>PG 4</p> <p>PG 5</p> <p>PG 6</p> <p>PG 7</p> <p>Leather*</p>	<p>934</p> <p>976</p> <p>1 024</p> <p>1 072</p> <p>1 125</p> <p>1 184</p> <p>1 269</p> <p>1 395</p> <p>139</p> <p>42</p> <p>63</p>

Illustration	Description	Article number	Price group	EUR
	<p>Chair, high back 4-winged aluminium base with glides and tilt, turnable. Base black (37)</p> <p>*NB: Leather min. 2 chairs in same colour <i>Upcharge for Bolster upholstery pg 1-7**</i> <i>Upcharge polished alu (13) alt. white (31)</i> <i>Upcharge for felt glides</i> <i>Upcharge for auto-return</i></p>	<p>51 37 32H01-xxx</p> <p>51 xx 32H0B-xxx</p> <p>51 xx 32H01-xxx</p> <p>51 xx 32HF1-xxx</p> <p>51 xx 33H01-xxx</p>	<p>PG 1 PG 2 PG 3 PG 4 PG 5 PG 6 PG 7 Leather*</p>	<p>985 1 034 1 089 1 144 1 206 1 274 1 372 1 428 139 42 11 46</p>
	<p>Chair, medium back 4-winged aluminium base with glides and tilt, turnable. Base black (37)</p> <p>*NB: Leather min. 2 chairs in same colour <i>Upcharge for Bolster upholstery pg 1-7**</i> <i>Upcharge polished alu (13) alt. white (31)</i> <i>Upcharge for felt glides</i> <i>Upcharge for auto-return</i></p>	<p>51 37 32M01-xxx</p> <p>51 xx 32M0B-xxx</p> <p>51 xx 32M01-xxx</p> <p>51 xx 32MF1-xxx</p> <p>51 xx 33M01-xxx</p>	<p>PG 1 PG 2 PG 3 PG 4 PG 5 PG 6 PG 7 Leather*</p>	<p>906 949 997 1 044 1 098 1 157 1 241 1 368 139 42 11 46</p>
	<p>Chair, high back. 5-winged black (37) steel base with castors and tilt, rotatable, fixed height 45 cm.</p> <p>*NB: Leather min. 2 chairs in same colour <i>Upcharge for Bolster upholstery pg 1-7**</i> <i>Upcharge for interval braked castors</i> <i>Upcharge for tilt and adj. Height 43-52 cm</i> <i>Upcharge for swing and adjustable height</i> <i>Upcharge opt.colours stand (black castors/tilt)</i></p>	<p>51 37 44H01-xxx</p> <p>51 xx 44H0B-xxx</p> <p>51 xx 44H11.xxx</p> <p>51 xx 45H01-xxx</p> <p>51 xx 41H01-xxx</p> <p>51 yy 44H01-xxx</p>	<p>PG 1 PG 2 PG 3 PG 4 PG 5 PG 6 PG 7 Leather*</p>	<p>1 190 1 239 1 294 1 349 1 411 1 479 1 577 1 633 139 27 28 96 63</p>
	<p>Chair, high back. 5-winged black (37) steel base with castors and tilt, rotatable, fixed height 45 cm.</p> <p>*NB: Leather min. 2 chairs in same colour <i>Upcharge for Bolster upholstery pg 1-7**</i> <i>Upcharge for interval braked castors</i> <i>Upcharge for tilt and adj. Height 43-52 cm</i> <i>Upcharge for swing and adjustable height</i> <i>Upcharge opt.colours stand (black castors/tilt)</i></p>	<p>51 37 44M01-xxx</p> <p>51 xx 44M0B-xxx</p> <p>51 xx 44MI1.xxx</p> <p>51 xx 45M01-xxx</p> <p>51 xx 41M01-xxx</p> <p>51 yy 44M01-xxx</p>	<p>PG 1 PG 2 PG 3 PG 4 PG 5 PG 6 PG 7 Leather*</p>	<p>1 111 1 153 1 201 1 249 1 302 1 361 1 446 1 572 139 27 28 96 63</p>

Illustration	Description	Article number	Price group	EUR
	<p>Chair, high back, 4 metal legs Base white (31) or black (37).</p> <p>*NB: Leather min. 2 chairs in same colour <i>Upcharge for Bolster upholstery pg 1-7**</i> <i>Upcharge for base in chrome (13)</i></p>	<p>51 xx 20H01-xxx</p> <p>51 xx 20H0B-xxx</p> <p>51 13 20H01-xxx</p>	<p>PG 1 PG 2 PG 3 PG 4 PG 5 PG 6 PG 7 Leather*</p>	<p>796 845 900 955 1 017 1 085 1 182 1 238 139 36</p>
	<p>Chair, medium back, 4 metal legs Base white (31) or black (37).</p> <p>*NB: Leather min. 2 chairs in same colour <i>Upcharge for Bolster upholstery pg 1-7**</i> <i>Upcharge for base in chrome (13)</i></p>	<p>51 xx 20M01-xxx</p> <p>51 xx 20M0B-xxx</p> <p>51 13 20M01-xxx</p>	<p>PG 1 PG 2 PG 3 PG 4 PG 5 PG 6 PG 7 Leather*</p>	<p>717 759 807 854 908 967 1 051 1 178 139 36</p>
	<p>Chair, high back 4 wooden legs in oak (03) or ash (06).</p> <p>*NB: Leather min. 2 chairs in same colour <i>Upcharge for Bolster upholstery pg 1-7**</i> <i>Upcharge for stained legs; white oak (30), black ash (86), white ash (10), dark ash (76) Blue (D4).</i></p>	<p>51 xx 15H01-xxx</p> <p>51 xx 15H0B-xxx</p> <p>51 xx 15H01-xxx</p>	<p>PG 1 PG 2 PG 3 PG 4 PG 5 PG 6 PG 7 Leather*</p>	<p>910 958 1 013 1 069 1 130 1 198 1 296 1 352 139 76</p>
	<p>Chair, medium back 4 wooden legs in oak (03) or ash (06).</p> <p>*NB: Leather min. 2 chairs in same colour <i>Upcharge for Bolster upholstery pg 1-7**</i> <i>Upcharge for stained legs; white oak (30), black ash (86), white ash (10), dark ash (76) Blue (D4).</i></p>	<p>51 xx 15M01-xxx</p> <p>51 xx 15M0B-xxx</p> <p>51 xx 15M01-xxx</p>	<p>PG 1 PG 2 PG 3 PG 4 PG 5 PG 6 PG 7 Leather*</p>	<p>842 884 932 980 1 033 1 092 1 177 1 303 139 76</p>



Illustration	Description	Article number	Price group	EUR
Glove Bolster Cover Design: Fredrik Mattson				
<p style="text-align: center;">Glove BOLSTER COVER</p> <ul style="list-style-type: none"> • Dressing fabric for Glove High and Medium. • Channel-sewn upholstery in fabrics from price group 1-7 with exception of artificial leather. • With zippers for easy mounting on existing chair. <ul style="list-style-type: none"> • For more product information see www.horreds.se 				
	<p>Dressing fabric for Glove High with steel stand</p> <p>Dressing fabric for Glove High with wooden stand</p> <p><i>Note: PG 1-7 excluding artificial leathers</i></p>	<p>51 BHS -xxx</p> <p>51 BHT -xxx</p>	<p>PG 1</p> <p>PG 2</p> <p>PG 3</p> <p>PG 4</p> <p>PG 5</p> <p>PG 6</p> <p>PG 7</p>	<p>365</p> <p>415</p> <p>465</p> <p>516</p> <p>574</p> <p>651</p> <p>767</p>
	<p>Dressing fabric for Glove Medium with steel stand</p> <p>Dressing fabric for Glove Medium with wooden stand</p> <p><i>Note: PG 1-7 excluding artificial leathers</i></p>	<p>51 BMS -xxx</p> <p>51 BMT -xxx</p>	<p>PG 1</p> <p>PG 2</p> <p>PG 3</p> <p>PG 4</p> <p>PG 5</p> <p>PG 6</p> <p>PG 7</p>	<p>342</p> <p>388</p> <p>433</p> <p>479</p> <p>532</p> <p>602</p> <p>707</p>


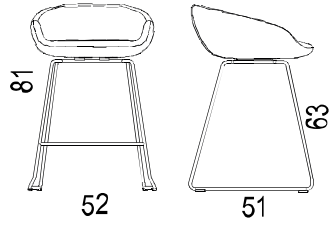
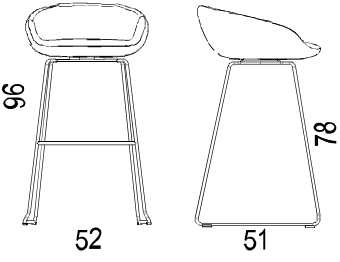
Illustration	Description	Article number	Price group	EUR
<p>Glove Bar Design: Fredrik Mattson</p>				
	<p>Glove Bar</p> <ul style="list-style-type: none"> Fully upholstered seat of molded cold foam (HR) with metal frame.. Stand of 12 mm wire. Upcharge for CMHR-skum: € 30. For more product information see www.horreds.se <p>Stand: Black RAL 9005 smooth gl.30 (37) (Other colours against quotation)</p>			
	<p>Bar stool with black stand, seating height 630 mm</p> <p>*NB:Leather min.2 pcs in same colour Upcharge for felt glides</p>	<p>51 37 60B01-xxx</p> <p>51 37</p>	<p>PG 1 PG 2 PG 3 PG 4 PG 5 PG 6 PG 7 Leather*</p>	<p>575 599 626 654 684 718 766 1 009 10</p>
	<p>Bar stool with black stand, seating height 780 mm</p> <p>*NB:Leather min.2 pcs in same colour Upcharge for felt glides</p>	<p>51 37 61B01-xxx</p> <p>51 37 61BF1-xxx</p>	<p>PG 1 PG 2 PG 3 PG 4 PG 5 PG 6 PG 7 Leather*</p>	<p>628 653 680 707 738 772 820 1 063 10</p>




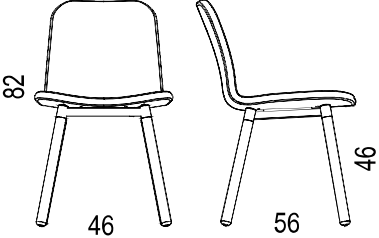
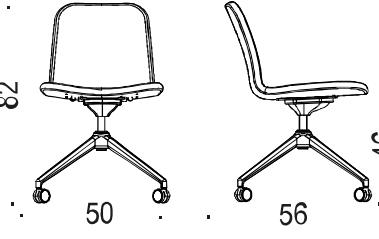
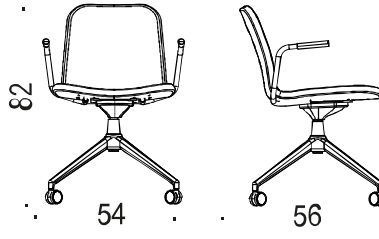
Illustration	Description	Article number	Price group	EUR
Cuba				
	Cuba chair			
	<ul style="list-style-type: none"> Fully upholstered seat of molded plywood with cold foa Wooden legs in clear coated solid oak / ash are stande stained against upcharge: <ol style="list-style-type: none"> Oak; white pigmented Ash; white pigmented, black stained, dark stained Burgundy stain, Conifer stain and Smokey Blue stai 4-wing black aluminum stand (RAL9005) with/whitout castors. 4-legged black (RAL 9005) steel. For more product information see www.horreds.se 			
				
	<p>Chair</p> <p>Wooden legs (cylindrical) in solid oak or ash, clear coated.</p> <p>Seating height 46cm</p> <p>Frame in metal, black RAL 9005</p> <p>Oak (03), Ash (06)</p> <p>*NB: Leather min.4 pcs in same colour</p> <p><i>Upcharge for stained legs</i></p>	<p>34 xx 1537-xxx</p> <p>34 xx 1037-xxx</p>	<p>PG 1</p> <p>PG 2</p> <p>PG 3</p> <p>PG 4</p> <p>PG 5</p> <p>PG 6</p> <p>PG 7</p> <p>Leather*</p>	<p>467</p> <p>486</p> <p>508</p> <p>530</p> <p>554</p> <p>581</p> <p>620</p> <p>707</p> <p>72</p>
	<p>Chair</p> <p>4-wing aluminum stand, with castors, fixed height, tilt, swivel.</p> <p>Seating height 46cm</p> <p>Black RAL 9005</p> <p>*NB: Leather min.4 pcs in same colour</p> <p><i>Upcharge for height adj. 42-52 cm</i></p> <p><i>Upcharge for interval braked wheels</i></p>	<p>34 37 30-xxx</p> <p>34 37 34-xxx</p> <p>34 37 30I-xxx</p>	<p>PG 1</p> <p>PG 2</p> <p>PG 3</p> <p>PG 4</p> <p>PG 5</p> <p>PG 6</p> <p>PG 7</p> <p>Leather*</p>	<p>552</p> <p>572</p> <p>595</p> <p>618</p> <p>643</p> <p>671</p> <p>712</p> <p>803</p> <p>25</p> <p>27</p>
	<p>Armchair</p> <p>4-wing aluminum stand, with castors, fixed height, tilt, swivel.</p> <p>Seating height 46cm</p> <p>Black RAL 9005</p> <p>*NB: Leather min.4 pcs in same colour</p> <p><i>Upcharge for height adj. 42-52 cm</i></p> <p><i>Upcharge for interval braked wheels</i></p>	<p>34 37 31-xxx</p> <p>34 37 35-xxx</p> <p>34 37 31I-xxx</p>	<p>PG 1</p> <p>PG 2</p> <p>PG 3</p> <p>PG 4</p> <p>PG 5</p> <p>PG 6</p> <p>PG 7</p> <p>Leather*</p>	<p>662</p> <p>683</p> <p>705</p> <p>728</p> <p>754</p> <p>782</p> <p>823</p> <p>914</p> <p>25</p> <p>27</p>

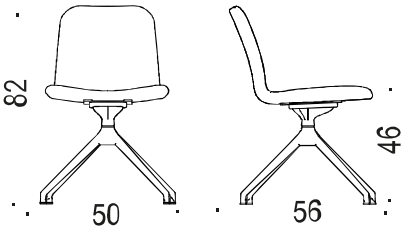
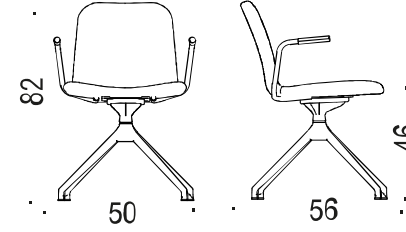
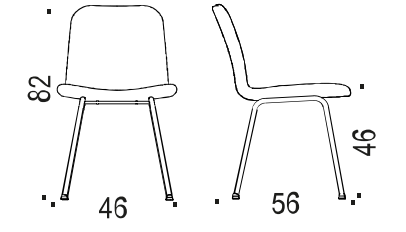
Illustration	Description	Article number	Price group	EUR
	<p>Chair 4-wing aluminum stand, with glides, fixed height, tilt, swivel. Seating height 46cm <i>Black RAL 9005</i></p> <p>*NB: Leather min.4 pcs in same colour <i>Upcharge for felt glides</i></p>	<p>34 37 32-xxx</p> <p>34 37 32F-xxx</p>	<p>PG 1 PG 2 PG 3 PG 4 PG 5 PG 6 PG 7 Leather*</p>	<p>552 572 595 618 643 671 712 803 11</p>
	<p>Armchair 4-wing aluminum stand, with glides, fixed height, tilt, swivel. Seating height 46cm <i>Black RAL 9005</i></p> <p>*NB: Leather min.4 pcs in same colour <i>Upcharge for felt glides</i></p>	<p>34 37 33-xxx</p> <p>34 37 33F-xxx</p>	<p>PG 1 PG 2 PG 3 PG 4 PG 5 PG 6 PG 7 Leather*</p>	<p>662 683 705 728 754 782 823 914 11</p>
	<p>Chair 4-legged steel RAL9005 Seating height 46cm</p> <p>*NB: Leather min.4 pcs in same colour <i>Upcharge for sliding feet with felt</i></p>	<p>34 37 20-xxx</p> <p>34 37 20F-xxx</p>	<p>PG 1 PG 2 PG 3 PG 4 PG 5 PG 6 PG 7 Leather*</p>	<p>0 332 352 373 395 420 447 485 572 11</p>




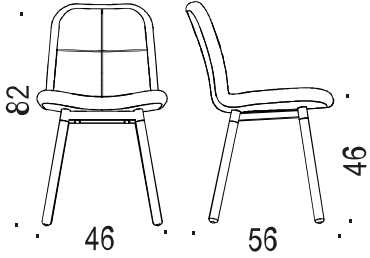
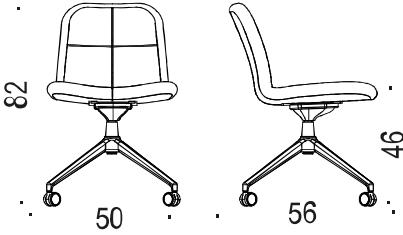
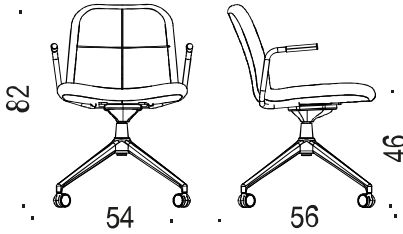

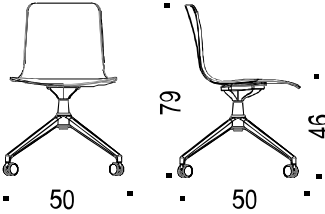

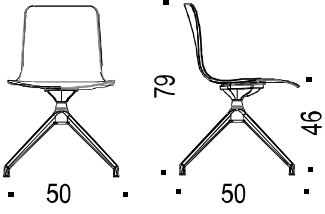
Illustration	Description	Article number	Price group	EUR
<h2>Cuba quiltad</h2>		 MÖBELFAKTA		
	<h3>Cuba, quilted</h3> <ul style="list-style-type: none"> Fully upholstered seat of molded plywood with cold foam. Quilted upholstery which is replaceable. Wooden legs in clear coated solid oak and ash. Stained legs against upcharge: <ol style="list-style-type: none"> Oak; white pigmented Ash; white pigmented, black stained, dark stained Burgundy stain, Conifer stain and Smokey Blue stain. 4-wing black (RAL 9005) aluminum stand, with/without castors. Other colours on request. 4-legged black (RAL 9005) steel. For more product information see www.horreds.se 			
	<p>Chair with quilted upholstery. Wooden legs (cylindrical) in solid oak (03) or ash (06). Clear coated. Seating height 46cm Frame in metal black RAL 9005</p> <p><i>*: Leather min 4 pcs in same colour</i> <i>Upcharge for stained legs</i></p>	<p>34Q xx 1537-xxx</p> <p>34Q xx 1537-xxx</p>	<p>PG 1 PG 2 PG 3 PG 4 PG 5 PG 6 PG 7 Leather*</p>	<p>524 549 577 605 637 673 725 827 72</p>
	<p>Chair with quilted upholstery. 4-wing aluminum stand w. castors. Fixed height, tilt, rotation. Seating height 46cm Black RAL 9005</p> <p><i>*NB:Leather min.4 pcs in same colour</i></p> <p><i>Upcharge for height adj. 42-52cm</i> <i>Upcharge for interval braked castors</i></p>	<p>34Q 37 30-xxx</p> <p>34Q 37 34-xxx</p> <p>34Q 37 301-xxx</p>	<p>PG 1 PG 2 PG 3 PG 4 PG 5 PG 6 PG 7 Leather*</p>	<p>609 635 664 693 725 763 817 923 25 27</p>
	<p>Armhair with quilted upholstery. 4-wing aluminum stand w. castors. Fixed height, tilt, rotation. Seating height 46cm Black RAL 9005</p> <p><i>*NB:Leather min.4 pcs in same colour</i></p> <p><i>Upcharge for height adj. 42-52cm</i> <i>Upcharge for interval braked castors</i></p>	<p>34Q 37 31-xxx</p> <p>34Q 37 35-xxx</p> <p>34Q 37 311-xxx</p>	<p>PG 1 PG 2 PG 3 PG 4 PG 5 PG 6 PG 7 Leather*</p>	<p>719 746 775 804 836 874 928 1 034 25 27</p>

Illustration	Description	Article number	Price group	EUR
	<p>Chair with quilted upholstery 4-wing aluminum stand with sliding feet, fixed height, tilt, rotation. Seating height 46cm Black RAL 9005</p> <p>*: Leather min.4 pcs in same colour <i>Upcharge for sliding feet with felt</i></p>	<p>34Q 37 32-xxx</p> <p>34Q 37 32F-xxx</p>	<p>PG 1 PG 2 PG 3 PG 4 PG 5 PG 6 PG 7 Leather*</p>	<p>609 635 664 693 725 763 817 923 11</p>
	<p>Armchair with quilted upholstery 4-wing aluminum stand with sliding feet, fixed height, tilt, rotation. Seating height 46cm Black RAL 9005</p> <p>*: Leather min.4 pcs in same colour <i>Upcharge for sliding feet with felt</i></p>	<p>34Q 37 33-xxx</p> <p>34Q 37 33F-xxx</p>	<p>PG 1 PG 2 PG 3 PG 4 PG 5 PG 6 PG 7 Leather*</p>	<p>719 746 775 804 836 874 928 1 034 11</p>
	<p>Chair with quilted upholstery 4-legged steel RAL9005 Seating height 46cm</p> <p>*: Leather min.4 pcs in same colour <i>Upcharge for sliding feet with felt</i></p>	<p>34Q 37 20-xxx</p> <p>34Q 37 20F-xxx</p>	<p>PG 1 PG 2 PG 3 PG 4 PG 5 PG 6 PG 7 Leather*</p>	<p>389 415 443 470 502 538 591 692 11</p>

Illustration	Description	Article number	Price group	EUR	Pris
Base Design: Anderssen & Voll					
	<p>Base med 4-vingat hjulstativ</p> <ul style="list-style-type: none"> • ChaiR with pressed seat shell. • Fully upholstered. Padding of cold foam (CMHR). • Thicker upholstery as option. • 4-winged aluminum base with castors and tilt function. • Castors with polyurethane roller conveyor, suitable for all floors. • Price for leather chairs in less than 4 pieces: against quotation • För mer produktinformation se www.horreds.se <p><u>Colours stands (xx):</u> 37 Black (RAL 9005) 13 Polished (against upcharge) NB: Model A60 only. <i>(Aother RAL colours against quotation)</i></p>				
	<p>Chair, 4-winged black aluminum stand with castors, fixed height, tilt, fully upholstered</p> <p>*Note:Leather min 4 pcs in same colour</p> <p><i>Upcharge for thicker upholstery</i> <i>Upcharge for polished stand</i></p>	<p>65 A60 xx 97-xxx 65 A60 xx 97-xxx 65 A60 xx 97-xxx 65 A60 xx 97-xxx 65 A60 xx 97-xxx 65 A60 xx 97-xxx 65 A60 xx 97-xxx 65 A60 xx 97-xxx 65 A60 xx 97-xxx 65 B61 xx 97-xxx 65 A60 13 97-xxx</p>	<p>PG 1 PG 2 PG 3 PG 4 PG 5 PG 6 PG 7 Leather*</p>	<p>679 703 730 757 787 821 868 976 59 44</p>	
Base 4-wing leg stand					
	<ul style="list-style-type: none"> • Chair with pressed seat shell. • Fully upholstered.Padding of cold foam (CMHR). • Thicker upholstery as option. • 4-winged aluminum base with tilt function. • Upcharge for felt glides. • Price for leather chairs in less than 4 pieces: against quotation • Fore more information, see www.horreds.se <p><u>Colours stands (xx):</u> 37 Black (RAL 9005) 13 Polished (against upcharge) <i>(Aother RAL colours against quotation)</i></p>				
	<p>Chair, 4-winged black aluminum stand without castors, fixed height, tilt, fully upholstered</p> <p>*Note:Leather min 4 pcs in same colour</p> <p><i>Upcharge for thicker upholstery</i> <i>Upcharge for polished stand</i> <i>Upcharge for sliding feet with felt</i></p>	<p>65 A62 xx 97-xxx 65 A62 xx 97-xxx 65 A62 xx 97-xxx 65 A62 xx 97-xxx 65 A62 xx 97-xxx 65 A62 xx 97-xxx 65 A62 xx 97-xxx 65 A62 xx 97-xxx 65 A62 xx 97-xxx 65 A62 13 97-xxx</p>	<p>Prisgrupp 1 Prisgrupp 2 Prisgrupp 3 Prisgrupp 4 Prisgrupp 5 Prisgrupp 6 Prisgrupp 7 Läder*</p>	<p>679 703 730 757 787 821 868 976 59 44 12</p>	

Base Design: Anderssen & Voll



Base med 5-vingat hjulstativ

- Chair with pressed seat shell
- Fully upholstered. Padding of cold foam (CMHR).
- Kanalsydd klädsel mot tillägg
- Castors with polyurethane roller conveyor, suitable for all floors.
- Thicker upholstery as option.
- Price for leather chairs in less than 4 pieces: against quotation
- Fore more information, see www.horreds.se

Colours stands (xx):

37 Black (RAL 9005)

(Aother RAL colours against quotation

	<p>Chair, 5-wing black stand with castors, fixed height, tilt, fully upholstered.</p>	<p>65 A50 37 97-xxx 65 A50 37 97-xxx 65 A50 37 97-xxx 65 A50 37 97-xxx 65 A50 37 97-xxx 65 A50 37 97-xxx 65 A50 37 97-xxx 65 A50 37 97-xxx</p>	<p>PG 1 PG 2 PG 3 PG 4 PG 5 PG 6 PG 7 Leather*</p>	<p>794 818 845 872 902 935 983 1 091</p>
	<p>*NB: Leather min. 4 chairs in same colour</p>			
	<p><i>Upcharge for adjustable height 44-53 cm</i></p>	<p>65 A52 37 97-xxx</p>		<p>29</p>
	<p><i>Upcharge for interval braked castors</i></p>	<p>65 xxx 37 97-xxx</p>		<p>28</p>
	<p><i>Upcharge for thicker upholstery</i></p>	<p>65 B50 37 97-xxx</p>		<p>59</p>

Base Design: Anderssen & Voll



Base med 4-bent stativ

- Stackable chair / armchair with pressed seat shell.
- Fully upholstered. Stopping in cold foam.
- Veneered in clear coated oak and dark stained ash.
- Stack protection in felt for upholstered chairs.
- Recommended stacking height: max 8 charis.
- Connectable in version without upholstery.
- Stand of 19 mm steel pipe, black TPE armrests, black plastic feet.
- Price for leather chairs in less than 4 pieces; against quotation.
- For more product information; see www.horreds.se

Colour stands (xx):

37 Black (RAL 9005)

13 Chrome: Models A11 and A10 only

(Other RAL colours against quotation)

	<p>Chair with upholstered seat shell, Incl stack protection in felt, black or chrome</p> <p><i>*Note: Leather min.4 chairs in same color</i></p> <p><i>Upcharge for sliding feet with felt</i> <i>Upcharge for thicker upholstery</i></p>	<p>65 A11 xx 97-xxx 65 A11 xx 97-xxx 65 A11 xx 97-xxx 65 A11 xx 97-xxx 65 A11 xx 97-xxx 65 A11 xx 97-xxx 65 A11 xx 97-xxx 65 A11 xx 97-xxx 65 A11 xx 97-xxx 65 A11 xx 97Fxxx 65 B11 xx 97-xxx</p>	<p>PG 1 PG 2 PG 3 PG 4 PG 5 PG 6 PG 7 Leather*</p>	<p>566 590 617 644 674 707 755 863 29 59</p>
	<p>Armchair with upholstered seat shell, Incl stack protection in felt, black. Black stand</p> <p><i>*Note: Leather min.4 chairs in same color</i></p> <p><i>Upcharge for sliding feet with felt</i> <i>Upcharge for thicker upholstery</i></p>	<p>65 A21 37 97-xxx 65 A21 37 97-xxx 65 A21 37 97-xxx 65 A21 37 97-xxx 65 A21 37 97-xxx 65 A21 37 97-xxx 65 A21 37 97-xxx 65 A21 37 97-xxx 65 A21 37 97-xxx 65 A21 37 97-xxx 65 A21 37 97-xxx 65 B21 37 97-xxx</p>	<p>PG 1 PG 2 PG 3 PG 4 PG 5 PG 6 PG 7 Leather*</p>	<p>752 775 802 829 860 893 941 1 049 29 59</p>
	<p>Chair with veneered seat shell, black or chrome</p> <p><i>Upcharge for connecting fittings</i> <i>Upcharge for sliding feet with felt</i></p>	<p>65 A10 xx 03 65 A10 xx 76 65 A12 xx xx 65 A10 xx xxF</p>	<p>Oak Dark ash</p>	<p>396 396 64 29</p>
	<p>Armchair with veneered seat shell, black.</p> <p><i>Upcharge for connecting fittings</i> <i>Upcharge for sliding feet with felt</i></p>	<p>65 A20 37 03 65 A20 37 76 65 A22 37 xx 65 A22 37 xxF</p>	<p>Oak Dark ash</p>	<p>583 583 64 29</p>

Base Design: Anderssen & Voll

Base with sled base



- Stackable chair with pressed seat shell
- Fully upholstered. Stopping in cold foam
- Veneered in oak nature and dark stained ash
- Sled base of 12 mm wire
- Stack protection in felt for upholstered chairs.
- Connectable
- Price for leather chairs in less than 4 pieces: against quotation
- For more product information: see www.horreds.se

Colour stands (xx):

37 Black (RAL 9005)

(Other RAL colours against quotation)

	<p>Chair with black sled base, fully upholstered</p> <p>*NB: Leather min.4 chairs in same colour</p> <p><i>Upcharge for thicker upholstery</i></p> <p><i>Upcharge for sliding feet with felt</i></p> <p><i>Upcharge cost for connecting fittings</i></p>	<p>65 A40 37 97-xxx</p> <p>65 A40 37 97-xxx</p> <p>65 A40 37 97-xxx</p> <p>65 A40 37 97-xxx</p> <p>65 A40 37 97-xxx</p> <p>65 A40 37 97-xxx</p> <p>65 A40 37 97-xxx</p> <p>65 A40 37 97-xxx</p> <p>65 A40 37 97-xxx</p> <p>65 B40 37 97-xxx</p> <p>65 A40 37 97-Fxxx</p> <p>65 A42 37 97-xxx</p>	<p>PG 1</p> <p>PG 2</p> <p>PG 3</p> <p>PG 4</p> <p>PG 5</p> <p>PG 6</p> <p>PG 7</p> <p>Leather*</p>	<p>490</p> <p>514</p> <p>541</p> <p>568</p> <p>598</p> <p>631</p> <p>679</p> <p>787</p> <p>59</p> <p>12</p> <p>17</p>
	<p>Chair with black sled base, veneered seat shell</p> <p><i>Upcharge for sliding feet with felt</i></p> <p><i>Upcharge cost for connecting fittings</i></p>	<p>65 A40 37 03</p> <p>65 A40 37 76</p> <p>65 A40 37 xxF</p> <p>65 A42 37 xx</p>	<p>Oak</p> <p>Dark ash</p>	<p>329</p> <p>329</p> <p>12</p> <p>17</p>



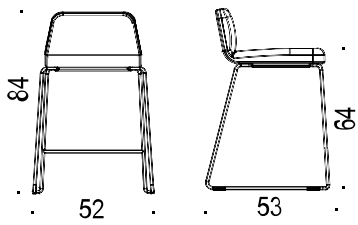
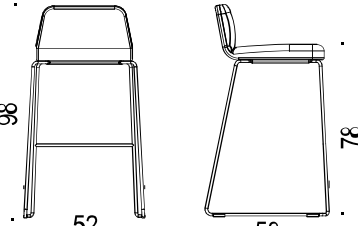
Illustration	Description	Article number	Price group	EUR
<h2>VX Bar stool</h2>				
	<p>VX BAR STOOL</p> <ul style="list-style-type: none"> • Upholstered seat of molded plywood with cold foam • Stand of 12 mm wire, stackable 4 pcs • Stack protection in molded felt (anthracite gray) • For more product information; see www.horreds.se <p style="text-align: center;"><u>Stand:</u> Black RAL 9005 str (37) Chrome (13) Other colour against quotation</p>			
	<p>Bar stool, seat height 640 mm</p> <p>*NB: Leather min. 2 chairs in same colour</p> <p><i>Upcharge for chrome</i></p> <p><i>Upcharge for sliding feet with felt</i></p>	<p>34 xx 07290-xxx</p> <p>34 13 07290-xxx</p> <p>34 xx 07290Fxxx</p>	<p>PG 1</p> <p>PG 2</p> <p>PG 3</p> <p>PG 4</p> <p>PG 5</p> <p>PG 6</p> <p>PG 7</p> <p>Leather*</p>	<p>476</p> <p>500</p> <p>527</p> <p>554</p> <p>584</p> <p>617</p> <p>665</p> <p>903</p> <p>47</p> <p>12</p>
	<p>Bar stool, seat height 780 mm</p> <p>*NB: Leather min. 2 chairs in same colour</p> <p><i>Upcharge for chrome</i></p> <p><i>Upcharge for sliding feet with felt</i></p>	<p>34 xx 07295-xxx</p> <p>34 13 07295-xxx</p> <p>34 xx 07295Fxxx</p>	<p>PG 1</p> <p>PG 2</p> <p>PG 3</p> <p>PG 4</p> <p>PG 5</p> <p>PG 6</p> <p>PG 7</p> <p>Leather*</p>	<p>496</p> <p>519</p> <p>547</p> <p>573</p> <p>604</p> <p>637</p> <p>684</p> <p>922</p> <p>47</p> <p>12</p>


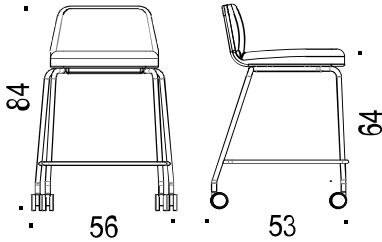


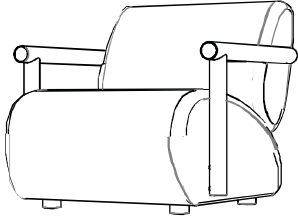
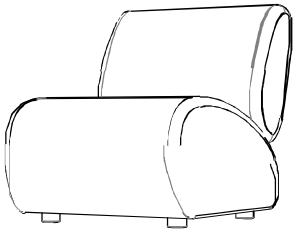
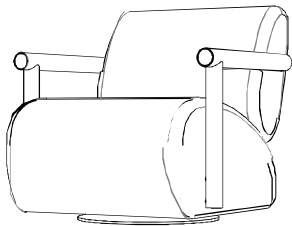
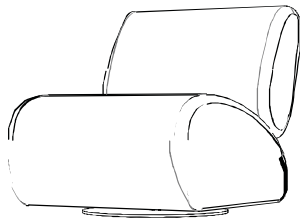
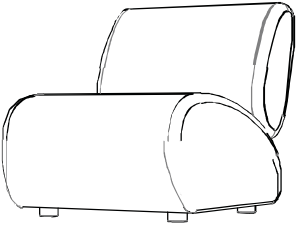
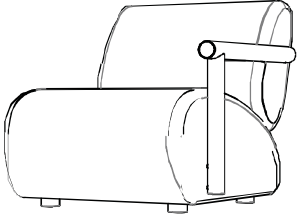
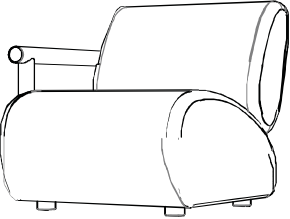
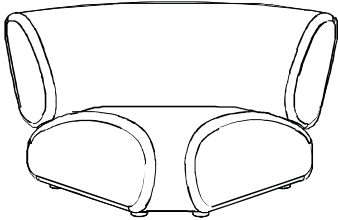
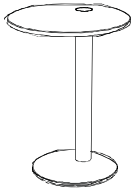
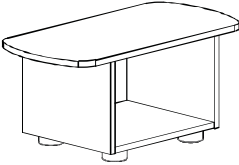
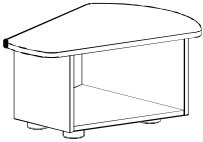
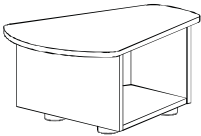
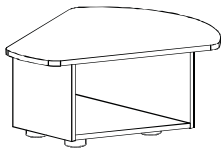
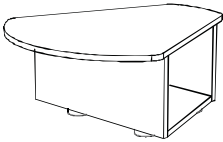
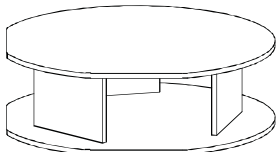
Illustration	Description	Article number	Price group	EUR
VX Bar stool with castors				
	<p>VX Bar stool with castors</p> <ul style="list-style-type: none"> • Upholstered seat of molded plywood with cold foam. • Stand made of 19mm steel tube, footrest made of 14mm wire.. • Interval braked castors, polyurethane roller track, suitable for all floors. • Stack coverin molded felt, anthracite grey. • or more product information see www.horreds.se <p style="text-align: center;"><u>Colour stand:</u> Black RAL 9005 (37) (Other colours on request)</p>			
	<p>4-legged with castors, black, seat height 640 mm</p> <p>*NB: Leather minimum number 2 pcs in the same colour.</p>	<p>34 37 08993-xxx</p>	<p>PG 1 PG 2 PG 3 PG 4 PG 5 PG 6 PG 7 Leather*</p>	<p>532 556 583 610 640 673 720 959</p>

Illustration	Description	Article number	Price group	EUR
LOG Design: Studio Stockholm Arkitektur				
<p>LOG Fåtölj / Modulsoffa</p>  <ul style="list-style-type: none"> • Fully upholstered modular sofa with a seat height of 41 cm. • Wood and metal frame with HR foam. • CMHR foam upcharge € 144 / seating module. • Legs in solid oak, height 30mm. • For different fabrics in the seat and back, the price of the higher fabric group plus an upcharge of € 60 applies. • Coupling fittings to be ordered separately. • Leather modules against quotation • For more product information see www.horreds.se 				
Armchairs				
	<p>Armchair with feet and armrests in hard wax oiled oak (D5) or black stained oak (73).</p> <ul style="list-style-type: none"> • Width 77cm • Height 74cm (height armrests 56cm) • Depth 85cm • Seat height 41c, <p>Can not be coupled</p>	27 xx 202-xxx	PG 1 PG 2 PG 3 PG 4 PG 5 PG 6 PG 7	2 098 2 175 2 251 2 326 2 414 2 531 2 706
	<p>Armstir with feet in hard wax oiled oak (D5) or black stained oak 73)</p> <ul style="list-style-type: none"> • Width 65cm • Height 74cm • Depth 85cm • Seat height 41cm 	27 xx 200-xxx	PG 1 PG 2 PG 3 PG 4 PG 5 PG 6 PG 7	1 458 1 534 1 610 1 685 1 773 1 890 2 065
	<p>Armchair swivel with auto return.</p> <p>With armrest in hard wax oiled oak (D5) or blackstained oak (73). Black footplate.</p> <ul style="list-style-type: none"> • Width 770mm • Height 740mm (höjd armstöd 565mm) • Depth 850mm • Seat height 410mm <p>Can not be coupled</p>	27 xx 10202-xxx	PG 1 PG 2 PG 3 PG 4 PG 5 PG 6 PG 7	2 493 2 569 2 646 2 721 2 809 2 926 3 101
	<p>Armchair swivel with auto return.</p> <p>Black footplate.</p> <ul style="list-style-type: none"> • Width 65cm • Height 74cm • Depth 85cm • Seat height 41cm <p>Can not be coupled</p>	27 00 10200-xxx	PG 1 PG 2 PG 3 PG 4 PG 5 PG 6 PG 7	1 853 1 929 2 005 2 080 2 168 2 285 2 460

	Modular soffa			
	<p>Seating module with back. Feet in hard vax poöed pal (D5) or black stained oak (73)</p> <ul style="list-style-type: none"> • Width 65cm • Height 74cm • Depth 85cm • Seat height 41cm <p>Coupling fitting</p>	27 xx 200-xxx	PG 1 PG 2 PG 3 PG 4 PG 5 PG 6 PG 7	1 458 1 534 1 610 1 685 1 773 1 890 2 065 23
	<p>Seating module with back, armrest left side. Feet and armrest in hard vax oiled oak (D5) or black stained oak (73)</p> <ul style="list-style-type: none"> • Width 71cm • Height 74cm,(height armrests 56cm) • Depth 85cm • Seat height 41cm <p>Coupling fitting</p>	27 xx 201-xxx	PG 1 PG 2 PG 3 PG 4 PG 5 PG 6 PG 7	1 778 1 854 1 930 2 006 2 094 2 210 2 386 23
	<p>Seating module with back, armrest right side. Feet and armrest in hard vax oiled oak (D5) or black stained oak (73)</p> <ul style="list-style-type: none"> • Width 71cm • Height 74cm(height armrests 56cm) • Depth 85cm • Seat height 41cm <p>Coupling fitting</p>	27 xx 203-xxx	PG 1 PG 2 PG 3 PG 4 PG 5 PG 6 PG 7	1 778 1 854 1 930 2 006 2 094 2 210 2 386 23
	<p>Corner module w. back. Feet in hard vax oiled oak (D5) or black stained oak (73).</p> <ul style="list-style-type: none"> • Widht 95cm • Height 74cm • Depth 95cm • Seat height 41cm <p>Coupling fittings (1/joint)</p> <p>Note: connect to seat mdódules, not gainst coupling modules.</p>	27 xx 300-xxx	PG 1 PG 2 PG 3 PG 4 PG 5 PG 6 PG 7	2 265 2 373 2 481 2 588 2 714 2 879 3 129 23
	<p>Laptop table. Top, leg and foot in hard vax oiled oak or black stained oak. Black metal parts.</p> <ul style="list-style-type: none"> • Height 60cm • Top Ø40cm • Foot Ø30cm 	27 D5 09245 27 73 09245	Vax oiled Black stain	800 800

<h3 style="text-align: center;">Kopplingsmoduler</h3> <ul style="list-style-type: none"> • Coupling modules in hard vax oiled oak or black stained oak. • Height 29cm. • For connection between 2 seating modules. • Not intended as stand-alone modules • Electrical outlet as an option 				
	Table connection, straight, in hard vax oiled oak or black stained oak. Height 29cm.	27 D5 09130 27 73 09130	Vax oiled Black stain	545 545
	Same as above but with hole for 1 power outlet at the front	27 D5 09130K 27 73 09130K	Vax oiled Black stain	545 545
	Coupling fittings (1/joint)	27001		23
	Table coupling, 30° inside, in hard vax oiled oak or black stained oak. Height 29cm.	27 D5 09135I 27 73 09135I	Vax oiled Black stain	653 653
	Same as above but with hole for 1 power outlet at the front	27 D5 09135IK 27 73 09135IK	Vax oiled Black stain	653 653
	Table coupling, 30° outside, in hard vax oiled oak or black stained oak. Height 29cm.	27 D5 09135U 27 73 09135U	Vax oiled Black stain	653 653
	Same as above but with hole for 1 power outlet at the front	27 D5 09135UK 27 73 09135UK	Vax oiled Black stain	653 653
	Table coupling, 45° inside, in hard vax oiled oak or black stained oak. Height 29cm.	27 D5 09140I 27 73 09140I	Vax oiled Black stain	690 690
	Same as above but with hole for 1 power outlet at the front	27 D5 09140IK 27 73 09140I	Vax oiled Black stain	690 690
	Table coupling, 45° outside, in hard vax oiled oak or black stained oak. Height 29cm.	27 D5 09140U 27 73 09140U	Vax oiled Black stain	690 690
	Same as above but with hole for 1 power outlet at the front	27 D5 09140UK 27 73 09140UK	Vax oiled Black stain	690 690
	Table coupling, corner 90°, in hard vax oiled oak or black stained oak. Height 29cm. (not available with power outlet)	27 D5 09125 27 73 09125	Vax oiled Black stain	775 775
	Coupling fittings (1/joint)	27001		23

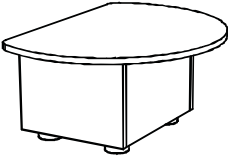
	<p>Table coupling / final module in hard wax oiled oak or black stained oak .Height 29cm. Connects to straight seating module (not corner module). Width 45cm, height 29cm.</p>	<p>27 D5 09185 27 73 09185</p>	<p>Vax oiled 576 Black stain 576</p>	
	<p>Same as above but with hole for 1 power outlet left side</p>	<p>27 D5 09185KV 27 73 09185KV</p>	<p>Vax oiled 576 Black stain 576</p>	
	<p>Same as above but with hole for 1 power outlet right side</p>	<p>27 D5 09185KH 27 73 09185KH</p>	<p>Vax oiled 576 Black stain 576</p>	
	<p>Kopplingsbeslag (1/skarv)</p>	<p>27001</p>		<p>23</p>
	Power outlets to coupling modules			
	<p>Powerdot 1 x power incl cable entry 51 mm</p>	<p>935 -PM50 935 -PM50W</p>	<p>Black White</p>	<p>63 63</p>
	<p>Powerdot 2 x USB-C PD charger incl cable entry 51 mm</p>	<p>935 -PM52 935 -PM52W</p>	<p>Black White</p>	<p>144 144</p>


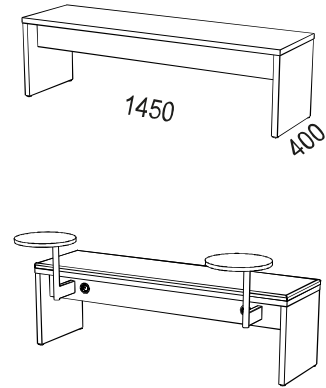
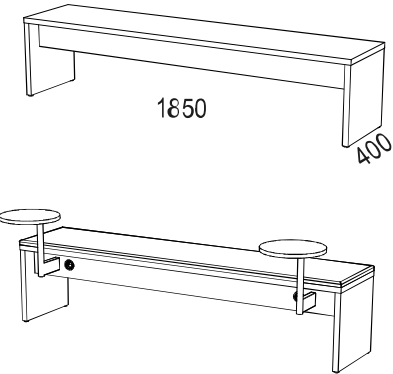
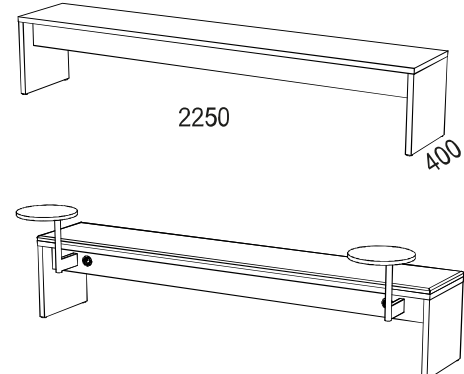
Illustration	Description	Article number	Price group	EUR																																												
Nomono Bench Design: Fredrik Mattson																																																
	<p>Nomono BENCH</p> <ul style="list-style-type: none"> Nomono Bench is made from 28mm mdf slat. 90 degree corners with straight, matching edge. Material: Oak (03) White oak (30) Burgundy stained ash (C8) Ash (06) White ash (10) Conifer stained ash (D3) Black st. ash (86) Smokey Blue stained ash (D4) Dark st. ash (76) Available in 3 lengths; 1450mm, 1850mm, 2250mm Optional: upholstered seat cushion Seat height in veneered version 450 mm, Seat height with upholstered cushion 460mm. Djup 400mm Table and / or electrical outlet as an option. Delivered unassembled. For more product information see www.horreds.se 																																															
	<p>Längd 1450mm</p> <p>Oak, ash, stained oak / ash</p> <p>With upholstered seat cushion</p> <table border="1"> <tr><td>53 xx</td><td>0145D</td><td>Veneered seat</td><td>1 357</td></tr> <tr><td>53 xx</td><td>0145A-x</td><td>Price group 1</td><td>1 443</td></tr> <tr><td>53 xx</td><td>0145A-x</td><td>Price group 2</td><td>1 473</td></tr> <tr><td>53 xx</td><td>0145A-x</td><td>Price group 3</td><td>1 505</td></tr> <tr><td>53 xx</td><td>0145A-x</td><td>Price group 4</td><td>1 538</td></tr> <tr><td>53 xx</td><td>0145A-x</td><td>Price group 5</td><td>1 576</td></tr> <tr><td>53 xx</td><td>0145A-x</td><td>Price group 6</td><td>1 627</td></tr> <tr><td>53 xx</td><td>0145A-x</td><td>Price group 7</td><td>1 699</td></tr> <tr><td>53 xx</td><td>0145A-x</td><td>Leather*</td><td>1 871</td></tr> <tr><td>53 xx</td><td>z145z-x</td><td></td><td>102</td></tr> <tr><td>53 xx</td><td>z145z-x</td><td></td><td>447</td></tr> </table> <p>*NB:min. 2 chairs in same colour</p> <p>Upcharge for 2 electrical outlets</p> <p>Upcharge 2xtables+2xel.outlets</p>				53 xx	0145D	Veneered seat	1 357	53 xx	0145A-x	Price group 1	1 443	53 xx	0145A-x	Price group 2	1 473	53 xx	0145A-x	Price group 3	1 505	53 xx	0145A-x	Price group 4	1 538	53 xx	0145A-x	Price group 5	1 576	53 xx	0145A-x	Price group 6	1 627	53 xx	0145A-x	Price group 7	1 699	53 xx	0145A-x	Leather*	1 871	53 xx	z145z-x		102	53 xx	z145z-x		447
53 xx	0145D	Veneered seat	1 357																																													
53 xx	0145A-x	Price group 1	1 443																																													
53 xx	0145A-x	Price group 2	1 473																																													
53 xx	0145A-x	Price group 3	1 505																																													
53 xx	0145A-x	Price group 4	1 538																																													
53 xx	0145A-x	Price group 5	1 576																																													
53 xx	0145A-x	Price group 6	1 627																																													
53 xx	0145A-x	Price group 7	1 699																																													
53 xx	0145A-x	Leather*	1 871																																													
53 xx	z145z-x		102																																													
53 xx	z145z-x		447																																													
	<p>Lenght 1850mm</p> <p>Oak, ash, stained oak / ash</p> <p>With upholstered seat cushion</p> <table border="1"> <tr><td>53 xx</td><td>0185D</td><td>Veneered seat</td><td>1 489</td></tr> <tr><td>53 xx</td><td>0185A-x</td><td>Price group 1</td><td>1 605</td></tr> <tr><td>53 xx</td><td>0185A-x</td><td>Price group 2</td><td>1 646</td></tr> <tr><td>53 xx</td><td>0185A-x</td><td>Price group 3</td><td>1 690</td></tr> <tr><td>53 xx</td><td>0185A-x</td><td>Price group 4</td><td>1 733</td></tr> <tr><td>53 xx</td><td>0185A-x</td><td>Price group 5</td><td>1 785</td></tr> <tr><td>53 xx</td><td>0185A-x</td><td>Price group 6</td><td>1 854</td></tr> <tr><td>53 xx</td><td>0185A-x</td><td>Price group 7</td><td>1 952</td></tr> <tr><td>53 xx</td><td>0185A-x</td><td>Leather*</td><td>2 003</td></tr> <tr><td>53 xx</td><td>z185z-x</td><td></td><td>102</td></tr> <tr><td>53 xx</td><td>z185z-x</td><td></td><td>447</td></tr> </table> <p>*NB:min. 2 chairs in same colour</p> <p>Upcharge for 2 electrical outlets</p> <p>Upcharge 2xtables+2xel.outlets</p>				53 xx	0185D	Veneered seat	1 489	53 xx	0185A-x	Price group 1	1 605	53 xx	0185A-x	Price group 2	1 646	53 xx	0185A-x	Price group 3	1 690	53 xx	0185A-x	Price group 4	1 733	53 xx	0185A-x	Price group 5	1 785	53 xx	0185A-x	Price group 6	1 854	53 xx	0185A-x	Price group 7	1 952	53 xx	0185A-x	Leather*	2 003	53 xx	z185z-x		102	53 xx	z185z-x		447
53 xx	0185D	Veneered seat	1 489																																													
53 xx	0185A-x	Price group 1	1 605																																													
53 xx	0185A-x	Price group 2	1 646																																													
53 xx	0185A-x	Price group 3	1 690																																													
53 xx	0185A-x	Price group 4	1 733																																													
53 xx	0185A-x	Price group 5	1 785																																													
53 xx	0185A-x	Price group 6	1 854																																													
53 xx	0185A-x	Price group 7	1 952																																													
53 xx	0185A-x	Leather*	2 003																																													
53 xx	z185z-x		102																																													
53 xx	z185z-x		447																																													
	<p>Length 2250mm</p> <p>Oak, ash, stained oak / ash</p> <p>With upholstered seat cushion</p> <table border="1"> <tr><td>53 xx</td><td>0225D</td><td>Veneered seat</td><td>1 622</td></tr> <tr><td>53 xx</td><td>0225A-x</td><td>Price group 1</td><td>1 759</td></tr> <tr><td>53 xx</td><td>0225A-x</td><td>Price group 2</td><td>1 807</td></tr> <tr><td>53 xx</td><td>0225A-x</td><td>Price group 3</td><td>1 859</td></tr> <tr><td>53 xx</td><td>0225A-x</td><td>Price group 4</td><td>1 911</td></tr> <tr><td>53 xx</td><td>0225A-x</td><td>Price group 5</td><td>1 972</td></tr> <tr><td>53 xx</td><td>0225A-x</td><td>Price group 6</td><td>2 054</td></tr> <tr><td>53 xx</td><td>0225A-x</td><td>Price group 7</td><td>2 169</td></tr> <tr><td>53 xx</td><td>0225A-x</td><td>Leather*</td><td>2 136</td></tr> <tr><td>53 xx</td><td>z225z-x</td><td></td><td>102</td></tr> <tr><td>53 xx</td><td>z225z-x</td><td></td><td>447</td></tr> </table> <p>*NB:min. 2 chairs in same colour</p> <p>Upcharge for 2 electrical outlets</p> <p>Upcharge 2xtables+2xel.outlets</p>				53 xx	0225D	Veneered seat	1 622	53 xx	0225A-x	Price group 1	1 759	53 xx	0225A-x	Price group 2	1 807	53 xx	0225A-x	Price group 3	1 859	53 xx	0225A-x	Price group 4	1 911	53 xx	0225A-x	Price group 5	1 972	53 xx	0225A-x	Price group 6	2 054	53 xx	0225A-x	Price group 7	2 169	53 xx	0225A-x	Leather*	2 136	53 xx	z225z-x		102	53 xx	z225z-x		447
53 xx	0225D	Veneered seat	1 622																																													
53 xx	0225A-x	Price group 1	1 759																																													
53 xx	0225A-x	Price group 2	1 807																																													
53 xx	0225A-x	Price group 3	1 859																																													
53 xx	0225A-x	Price group 4	1 911																																													
53 xx	0225A-x	Price group 5	1 972																																													
53 xx	0225A-x	Price group 6	2 054																																													
53 xx	0225A-x	Price group 7	2 169																																													
53 xx	0225A-x	Leather*	2 136																																													
53 xx	z225z-x		102																																													
53 xx	z225z-x		447																																													

Illustration	Description	Article number	EUR																																																
Mute Focus Design: Fredrik Mattson																																																			
	<p>Mute Focus SEATING FURNITURE</p> <ul style="list-style-type: none"> • Frame in lacquered or veneered chipboard. • Stuffing in HR foam. CMHR against upcharge. • Seat height 46 cm • Delivered assembled, only the table top needs to be assembled. • For more produk information see www.horreds.se <p><u>White lacquer:</u> NCS 0500-N <u>Veneer group 1:</u> Oak (03), Ash (06) <u>Veneer group 2:</u> Black ash (86), Dark ash (76), White oak (30), White ash (10)</p>																																																		
	<p><i>Mute Focus Low & Mute Focus, fully upholstered</i></p>			<p><i>Mute Focus Low & Mute Focus, veneered outside</i></p>																																															
	<p>Mute Focus Low, left, fully upholstered, 122x77x79cm. Incl. 1xpower + 1xdouble USB-C charger (PM50+52) Black metal legs. Delivered assembled, only the table needs to be assembled. Max.weight for table top: 50 kg. <i>Upcharge for CMHR</i></p>	<p>55Fxx 400V-xxx</p>	<table border="1"> <thead> <tr> <th>Fabric group</th> <th>Table white lacquer</th> <th>Table optional NCS</th> <th>Table veneer group 1</th> <th>Table veneer group 2</th> </tr> </thead> <tbody> <tr><td>PG 1</td><td>3 587</td><td>3 587</td><td>3 587</td><td>3 587</td></tr> <tr><td>PG 2</td><td>3 771</td><td>3 771</td><td>3 771</td><td>3 771</td></tr> <tr><td>PG 3</td><td>3 980</td><td>3 980</td><td>3 980</td><td>3 980</td></tr> <tr><td>PG 4</td><td>4 188</td><td>4 188</td><td>4 188</td><td>4 188</td></tr> <tr><td>PG 5</td><td>4 421</td><td>4 421</td><td>4 421</td><td>4 421</td></tr> <tr><td>PG 6</td><td>4 679</td><td>4 679</td><td>4 679</td><td>4 679</td></tr> <tr><td>PG 7</td><td>5 047</td><td>5 047</td><td>5 047</td><td>5 047</td></tr> <tr><td></td><td>72</td><td>72</td><td>72</td><td>72</td></tr> </tbody> </table>	Fabric group	Table white lacquer	Table optional NCS	Table veneer group 1	Table veneer group 2	PG 1	3 587	3 587	3 587	3 587	PG 2	3 771	3 771	3 771	3 771	PG 3	3 980	3 980	3 980	3 980	PG 4	4 188	4 188	4 188	4 188	PG 5	4 421	4 421	4 421	4 421	PG 6	4 679	4 679	4 679	4 679	PG 7	5 047	5 047	5 047	5 047		72	72	72	72			
Fabric group	Table white lacquer	Table optional NCS	Table veneer group 1	Table veneer group 2																																															
PG 1	3 587	3 587	3 587	3 587																																															
PG 2	3 771	3 771	3 771	3 771																																															
PG 3	3 980	3 980	3 980	3 980																																															
PG 4	4 188	4 188	4 188	4 188																																															
PG 5	4 421	4 421	4 421	4 421																																															
PG 6	4 679	4 679	4 679	4 679																																															
PG 7	5 047	5 047	5 047	5 047																																															
	72	72	72	72																																															
	<p>Mute Focus Low, right, fully upholstered, 122x77x79cm. Incl. 1xpower + 1xdouble USB-C charger (PM50+52) Black metal legs. Delivered assembled, only the table needs to be assembled. Max.weight for table top: 50 kg. <i>Upcharge for CMHR</i></p>	<p>55Fxx 400H-xxx</p>	<table border="1"> <thead> <tr> <th>Fabric group</th> <th>Table white lacquer</th> <th>Table optional NCS</th> <th>Table veneer group 1</th> <th>Table veneer group 2</th> </tr> </thead> <tbody> <tr><td>PG 1</td><td>3 587</td><td>3 587</td><td>3 587</td><td>3 587</td></tr> <tr><td>PG 2</td><td>3 771</td><td>3 771</td><td>3 771</td><td>3 771</td></tr> <tr><td>PG 3</td><td>3 980</td><td>3 980</td><td>3 980</td><td>3 980</td></tr> <tr><td>PG 4</td><td>4 188</td><td>4 188</td><td>4 188</td><td>4 188</td></tr> <tr><td>PG 5</td><td>4 421</td><td>4 421</td><td>4 421</td><td>4 421</td></tr> <tr><td>PG 6</td><td>4 679</td><td>4 679</td><td>4 679</td><td>4 679</td></tr> <tr><td>PG 7</td><td>5 047</td><td>5 047</td><td>5 047</td><td>5 047</td></tr> <tr><td></td><td>72</td><td>72</td><td>72</td><td>72</td></tr> </tbody> </table>	Fabric group	Table white lacquer	Table optional NCS	Table veneer group 1	Table veneer group 2	PG 1	3 587	3 587	3 587	3 587	PG 2	3 771	3 771	3 771	3 771	PG 3	3 980	3 980	3 980	3 980	PG 4	4 188	4 188	4 188	4 188	PG 5	4 421	4 421	4 421	4 421	PG 6	4 679	4 679	4 679	4 679	PG 7	5 047	5 047	5 047	5 047		72	72	72	72			
Fabric group	Table white lacquer	Table optional NCS	Table veneer group 1	Table veneer group 2																																															
PG 1	3 587	3 587	3 587	3 587																																															
PG 2	3 771	3 771	3 771	3 771																																															
PG 3	3 980	3 980	3 980	3 980																																															
PG 4	4 188	4 188	4 188	4 188																																															
PG 5	4 421	4 421	4 421	4 421																																															
PG 6	4 679	4 679	4 679	4 679																																															
PG 7	5 047	5 047	5 047	5 047																																															
	72	72	72	72																																															

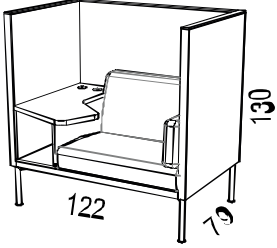
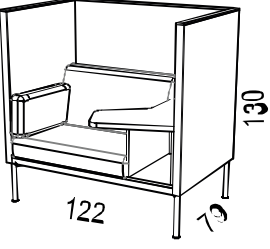
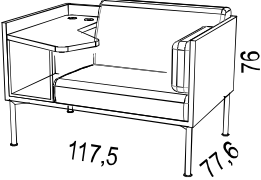
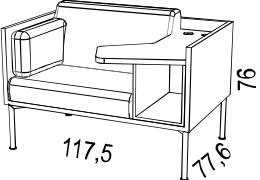
Illustration	Description	Article number	EUR				
			Fabric group	Table white lacquer	Table optional NCS	Table veneer group 1	Table veneer group 2
	<p>Mute Focus left, fully upholstered. 122x130x79cm. Incl. 1xpower + 1xdouble USB-C charger (PM50+52) Delivered assembled, only the table needs to be assembled. Max.weight for table top: 50 kg. <i>Upcharge for CMHR</i></p>	55Fxx 300V-xxx	PG 1	4 067	4 067	4 067	4 067
			PG 2	4 353	4 353	4 353	4 353
			PG 3	4 677	4 677	4 677	4 677
			PG 4	5 002	5 002	5 002	5 002
			PG 5	5 365	5 365	5 365	5 365
			PG 6	5 765	5 765	5 765	5 765
			PG 7	6 338	6 338	6 338	6 338
				97	97	97	97
	<p>Mute Focus right, fully upholstered. 122x130x79cm. Incl. 1xpower + 1xdouble USB-C charger (PM50+52) Delivered assembled, only the table needs to be assembled. Max.weight for table top: 50 kg. <i>Upcharge for CMHR</i></p>	55Fxx 300H-xxx	PG 1	4 067	4 067	4 067	4 067
			PG 2	4 353	4 353	4 353	4 353
			PG 3	4 677	4 677	4 677	4 677
			PG 4	5 002	5 002	5 002	5 002
			PG 5	5 365	5 365	5 365	5 365
			PG 6	5 765	5 765	5 765	5 765
			PG 7	6 338	6 338	6 338	6 338
				97	97	97	97
	<p>Mute Focus Low, left, 117,5x76x77,6cm. Incl. 1xpower + 1xdouble USB-C charger (PM50+52) Black metal legs. Delivered assembled, only the table needs to be assembled. Max.weight for table top: 50 kg. <i>Upcharge for CMHR</i></p>	55Fxx 200V-xxx	Fabric group	White laquer	Optional NCS	Veneer group 1	Veneer group 2
			PG 1	3 826	4 230	4 353	4 353
			PG 2	3 898	4 303	4 426	4 426
			PG 3	3 970	4 375	4 498	4 498
			PG 4	4 043	4 447	4 570	4 570
			PG 5	4 127	4 531	4 654	4 654
			PG 6	4 238	4 642	4 765	4 765
			PG 7	4 405	4 810	4 933	4 933
Läder	4 719	5 123	5 247	5 247			
	48	48	48	48			
	<p>Mute Focus Low, right, 117,5x76x77,6cm. Incl. 1xpower + 1xdouble USB-C charger (PM50+52) Black metal legs. Delivered assembled, only the table needs to be assembled. Max.weight for table top: 50 kg. <i>Upcharge for CMHR</i></p>	55Fxx 200H-xxx	PG 1	3 826	4 230	4 353	4 353
			PG 2	3 898	4 303	4 426	4 426
			PG 3	3 970	4 375	4 498	4 498
			PG 4	4 043	4 447	4 570	4 570
			PG 5	4 127	4 531	4 654	4 654
			PG 6	4 238	4 642	4 765	4 765
			PG 7	4 405	4 810	4 933	4 933
			Läder	4 719	5 123	5 247	5 247
	48	48	48	48			

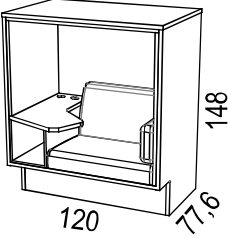
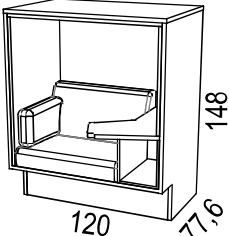
Illustration	Description	Article number	EUR				
			Fabric group	White laquer	Optional NCS	Veneer group 1	Veneer group 2
	<p>Mute Focus left 120x148x77,6cm. Incl. 1xpower + 1xdouble USB-C charger (PM50+52) Led lightning. Delivered assembled, only the table needs to be assembled. Max.weight for table top: 50 kg. <i>Upcharge for CMHR</i></p>	55Fxx 100V-xxx	PG 1	5 453	5 936	6 588	6 588
			PG 2	5 659	6 142	6 795	6 795
			PG 3	5 866	6 349	7 002	7 002
			PG 4	6 073	6 556	7 209	7 209
			PG 5	6 311	6 794	7 447	7 447
			PG 6	6 629	7 113	7 765	7 765
			PG 7	7 107	7 590	8 242	8 242
			Läder	7 195	7 678	8 330	8 330
				85	85	85	85
				<p>Mute Focus right 120x148x77,6cm. Incl. 1xpower + 1xdouble USB-C charger (PM50+52) Led lightning. Delivered assembled, only the table needs to be assembled. Max.weight for table top: 50 kg. <i>Upcharge for CMHR</i></p>	55Fxx 100H-xxx	PG 1	5 453
PG 2	5 659	6 142				6 795	6 795
PG 3	5 866	6 349				7 002	7 002
PG 4	6 073	6 556				7 209	7 209
PG 5	6 311	6 794				7 447	7 447
PG 6	6 629	7 113				7 765	7 765
PG 7	7 107	7 590				8 242	8 242
Läder	7 195	7 678				8 330	8 330
	85	85				85	85


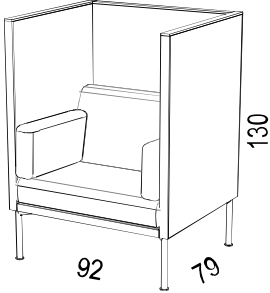
Illustration	Description	Article number	Price group	EUR
<p>Mute Focus fåtölj Design:Fredrik Mattson</p>				
	<p>Mute Focus Easy chair</p> <ul style="list-style-type: none"> • Upholstered easy chair with padding in HR foam • Seat height 46 cm • Delivered assembled • For more produkt information see; www.horreds.se 			
	<p>Mute Focus easy chair, upholstered 92x130x79cm Seat height 46cm Black metal legs. Delivered assembled.</p>	<p>55F 500 -xxx</p>	<p>PG 1 PG 2 PG 3 PG 4 PG 5 PG 6 PG 7</p>	<p>2 634 2 904 3 175 3 442 3 754 4 168 4 789</p>






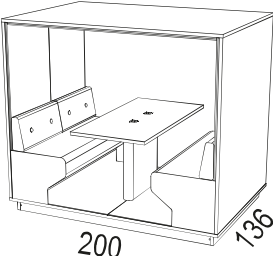
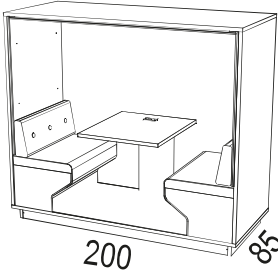
Illustration	Description	Article number	EUR																																																											
Mute Floor Design: Fredrik Mattson																																																														
 <p>Mute Floor SEATING FURNITURE</p> <ul style="list-style-type: none"> • Mute is made of lacquered alternatively veneered particle board • Padding in HR foam. CMHR against upcharge. • Sitthöjd 46 cm • Mute Floorx4 och Mute Floorx2 are delivered unassembled. Mute Floorx1 is delivered assembled. If you wish to have it sent unassembled, please notify customer service. • For more product information see www.horreds.se <p><u>White lacquer:</u> NCS 0500-N <u>Veneer group 1:</u> Oak (03), Ash (06) <u>Veneer group 2:</u> Black stained.Ash (86), Dark stained Ash (76), White pigm.Oak (30), White pigmented Ash (10)</p>																																																														
 <p>Mute Floor x4</p>			 <p>Mute Floor x2</p>			 <p>Mute Floor x1</p>																																																								
	<p>Mute Floor x4, 200x180x136cm. Inkl.2 xpower 2x double USB-C charger (PD50+52) LED lamp ,mat anthracite. Delivered knock-down. Max.weight for table top: 50 kg. <i>Upcharge for wooden back</i> <i>Upcharge for CMHR foam</i> No back wall, entrance from both sides</p>	55 xx 06790-xxx	<table border="1"> <thead> <tr> <th>Fabric group</th> <th>White laquer</th> <th>Optional NCS</th> <th>Veneer group 1</th> <th>Veneer group 2</th> </tr> </thead> <tbody> <tr><td>PG 1</td><td>14 111</td><td>14 953</td><td>15 795</td><td>15 795</td></tr> <tr><td>PG 2</td><td>14 474</td><td>15 316</td><td>16 158</td><td>16 158</td></tr> <tr><td>PG 3</td><td>14 837</td><td>15 679</td><td>16 521</td><td>16 521</td></tr> <tr><td>PG 4</td><td>15 200</td><td>16 042</td><td>16 884</td><td>16 884</td></tr> <tr><td>PG 5</td><td>15 563</td><td>16 405</td><td>17 247</td><td>17 247</td></tr> <tr><td>PG 6</td><td>16 186</td><td>17 029</td><td>17 871</td><td>17 871</td></tr> <tr><td>PG 7</td><td>17 122</td><td>17 964</td><td>18 806</td><td>18 806</td></tr> <tr><td>Leather</td><td>18 286</td><td>19 128</td><td>19 970</td><td>19 970</td></tr> <tr><td></td><td>2 302</td><td>2 302</td><td>2 749</td><td>2 749</td></tr> <tr><td></td><td>121</td><td>121</td><td>121</td><td>121</td></tr> </tbody> </table>	Fabric group	White laquer	Optional NCS	Veneer group 1	Veneer group 2	PG 1	14 111	14 953	15 795	15 795	PG 2	14 474	15 316	16 158	16 158	PG 3	14 837	15 679	16 521	16 521	PG 4	15 200	16 042	16 884	16 884	PG 5	15 563	16 405	17 247	17 247	PG 6	16 186	17 029	17 871	17 871	PG 7	17 122	17 964	18 806	18 806	Leather	18 286	19 128	19 970	19 970		2 302	2 302	2 749	2 749		121	121	121	121				
Fabric group	White laquer	Optional NCS	Veneer group 1	Veneer group 2																																																										
PG 1	14 111	14 953	15 795	15 795																																																										
PG 2	14 474	15 316	16 158	16 158																																																										
PG 3	14 837	15 679	16 521	16 521																																																										
PG 4	15 200	16 042	16 884	16 884																																																										
PG 5	15 563	16 405	17 247	17 247																																																										
PG 6	16 186	17 029	17 871	17 871																																																										
PG 7	17 122	17 964	18 806	18 806																																																										
Leather	18 286	19 128	19 970	19 970																																																										
	2 302	2 302	2 749	2 749																																																										
	121	121	121	121																																																										
	<p>Mute Floor x2, 200x180x85cm. Inkl.2 xpower 1x double USB-C charger (PD50+52) LED lamp ,mat anthracite. Delivered knock-down. Max.weight for table top: 50 kg. <i>Upcharge for CMHR foam</i> With back wall, entrance from one side</p>	55 xx 06985-xxx	<table border="1"> <thead> <tr> <th>Fabric group</th> <th>White laquer</th> <th>Optional NCS</th> <th>Veneer group 1</th> <th>Veneer group 2</th> </tr> </thead> <tbody> <tr><td>PG 1</td><td>8 825</td><td>10 298</td><td>11 183</td><td>11 183</td></tr> <tr><td>PG 2</td><td>9 188</td><td>10 662</td><td>11 546</td><td>11 546</td></tr> <tr><td>PG 3</td><td>9 551</td><td>11 025</td><td>11 909</td><td>11 909</td></tr> <tr><td>PG 4</td><td>9 732</td><td>11 206</td><td>12 090</td><td>12 090</td></tr> <tr><td>PG 5</td><td>10 095</td><td>11 569</td><td>12 453</td><td>12 453</td></tr> <tr><td>PG 6</td><td>10 644</td><td>12 118</td><td>13 002</td><td>13 002</td></tr> <tr><td>PG 7</td><td>11 467</td><td>12 941</td><td>13 825</td><td>13 825</td></tr> <tr><td>Leather</td><td>12 818</td><td>14 292</td><td>15 176</td><td>15 176</td></tr> <tr><td></td><td>85</td><td>85</td><td>85</td><td>85</td></tr> </tbody> </table>	Fabric group	White laquer	Optional NCS	Veneer group 1	Veneer group 2	PG 1	8 825	10 298	11 183	11 183	PG 2	9 188	10 662	11 546	11 546	PG 3	9 551	11 025	11 909	11 909	PG 4	9 732	11 206	12 090	12 090	PG 5	10 095	11 569	12 453	12 453	PG 6	10 644	12 118	13 002	13 002	PG 7	11 467	12 941	13 825	13 825	Leather	12 818	14 292	15 176	15 176		85	85	85	85									
Fabric group	White laquer	Optional NCS	Veneer group 1	Veneer group 2																																																										
PG 1	8 825	10 298	11 183	11 183																																																										
PG 2	9 188	10 662	11 546	11 546																																																										
PG 3	9 551	11 025	11 909	11 909																																																										
PG 4	9 732	11 206	12 090	12 090																																																										
PG 5	10 095	11 569	12 453	12 453																																																										
PG 6	10 644	12 118	13 002	13 002																																																										
PG 7	11 467	12 941	13 825	13 825																																																										
Leather	12 818	14 292	15 176	15 176																																																										
	85	85	85	85																																																										

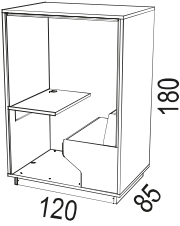
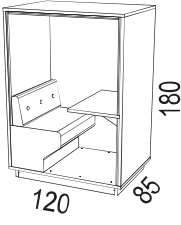
Illustration	Description	Article number	EUR				
			Fabric group	White laquer	Optional NCS	Veneer group 1	Veneer group 2
	<p>Mute Floor left 120x180x85cm. Inkl.1 xpower 1x double USB-C charger (PD50+52) LED lamp ,mat anthracite. Delivered assembled Max.weight for table top: 50 kg. <i>Upcharge for CMHR foam</i> With back wall, entrance from one side</p>	55 xx 311V-xxx	PG 1	6 426	7 689	8 194	8 194
			PG 2	6 607	7 871	8 376	8 376
			PG 3	6 970	8 234	8 739	8 739
			PG 4	7 152	8 415	8 921	8 921
			PG 5	7 515	8 778	9 284	9 284
			PG 6	7 914	9 177	9 682	9 682
			PG 7	8 513	9 776	10 281	10 281
			Leather	8 967	10 230	10 736	10 736
				60	60	60	60
			<p><i>NOTE: Mute Floor x1 (art 311V/H) is delivered assembled!</i> <i>Please notify customer service if it has to be delivered knock-down due to size limit of entrance doors.</i> <i>The width of the pallet is 95 cm.</i></p>				
	<p>Mute Floor right 120x180x85cm. Inkl.1 xpower 1x double USB-C charger (PD50+52) LED lamp, mat anthracite Delivered assembled Max.weight for table top: 50 kg. <i>Upcharge for CMHR foam</i> With back wall, entrance from one side</p>	55 xx 311H-xxx	PG 1	6 426	7 689	8 194	8 194
			PG 2	6 607	7 871	8 376	8 376
			PG 3	6 970	8 234	8 739	8 739
			PG 4	7 152	8 415	8 921	8 921
			PG 5	7 515	8 778	9 284	9 284
			PG 6	7 914	9 177	9 682	9 682
			PG 7	8 513	9 776	10 281	10 281
			Leather	8 967	10 230	10 736	10 736
				60	60	60	60
			<p><i>NOTE: Mute Floor x1 (art 311V/H) is delivered assembled!</i> <i>Please notify customer service if it has to be delivered knock-down due to size limit of entrance doors.</i> <i>The width of the pallet is 95 cm.</i></p>				




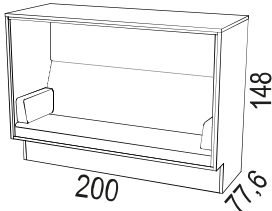
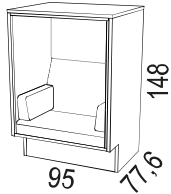
Illustration	Description	Article number	EUR				
Mute Design:Fredrik Mattson							
<p>Mute SOFA AND EASY CHAIR</p>  <ul style="list-style-type: none"> • Frame in lacquered or veneered chipboard. • Stuffing in HR foam. CMHR against upcharge. • Seat height 46 cm • Delivered assembled. • For more produk information see www.horreds.se <p>White lacquer: NCS 0500-N Veneer group 1: Oak (03), Ash (06) Veneer group 2: Black ash (86), Dark ash (76), White oak (30), White ash (10)</p>							
 <p>Mute sofa</p>		 <p>Mute easy chair</p>					
			Fabric group	White laquer	Optional NCS	Veneer group 1	Veneer group 2
	<p>Mute sofa with roof 200x148x77,6cm. Delivered assembled. <i>(Notify customer serv. at the time of ordering if you want it to be sent unassembled!)</i></p> <p>Upcharge for CMHR</p>	55 xx 04350-xxx	PG 1	6 587	7 293	9 005	9 005
			PG 2	6 860	7 565	9 277	9 277
			PG 3	7 114	7 819	9 532	9 532
			PG 4	7 295	8 001	9 713	9 713
			PG 5	7 604	8 309	10 022	10 022
			PG 6	8 003	8 708	10 421	10 421
			PG 7	8 602	9 307	11 020	11 020
			Leather	12 632	13 337	15 050	15 050
				85	85	85	85
	<p>Mute easy chair with roof 95x148x77,6cm. Delivered assembled.</p> <p>Upcharge for CMHR</p>	55 xx 03650-xxx	PG 1	4 633	5 338	5 641	5 641
			PG 2	4 815	5 520	5 822	5 822
			PG 3	4 960	5 665	5 967	5 967
			PG 4	5 087	5 792	6 094	6 094
			PG 5	5 268	5 974	6 276	6 276
			PG 6	5 518	6 223	6 525	6 525
			PG 7	5 892	6 597	6 899	6 899
			Leather	7 719	8 424	8 726	8 726
				60	60	60	60


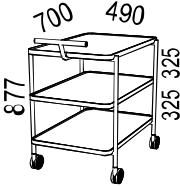
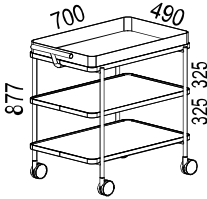
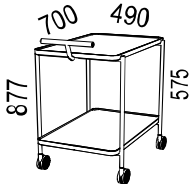
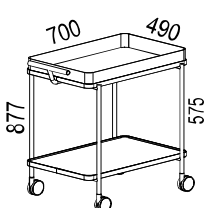



Illustration	Description	Article number	Material	EUR
EXO TROLLEY Design: Mathieu Gustafsson & Daniel Lavonius Jarefeldt, Tengbom				
	<p>EXO-TROLLEY Serving Trolley</p> <ul style="list-style-type: none"> • Trolley in black texture lacquer RAL9005 with castors. Other colours on request. • Shelves in white (31K) and black (37K) compact laminate alternatively oak and ash veneer; oak nature (03), ash nature (06) black ash (86), dark ash (76), white oak (30), white ash (10), stained ash Burgundy (C8), stained ash Conifer (D3) and stained ash Smokey Blue (D4). • Troughs in black metal and copper, • Serving tray and bottle holder in black metal with inlays matching the shelves. • 4 castors (diameter 75 mm) of which 2 are lockable. • Max weight capacity 50 kilos. • For more product information: see www.horreds.se 			
	<p>Trolley with 3 shelves in compact laminate alt. veneer New: height 877 mm</p>	84 37xx 08383-2	Black	1 574
	<p>Trolley with 1 trough and 2 shelves in compact laminate or veneer. New: height 877 mm <i>Add.cost for extra trough instead of shelf. Price per trough.</i></p>	84 37xx S8383-4 84 37xx K8383-4	Black/trough black Black/trough copper Black Copper	1 707 4 019 134 2 445
	<p>Trolley with 2 shelves in compact laminate alt. veneer New: height 877 mm</p>	84 37xx 08383-1	Black	1 348
	<p>Trolley with 1 trough and 1 shelf in compact laminate or veneer. New: height 877 mm <i>Add.cost for extra trough instead of shelf</i></p>	84 37xx S8383-3 84 37xx K8383-3	Black/trough black Black/trough copper Black Copper	1 483 3 794 134 2 445
	<p>Serving tray in black metal, with inlay in same material as shelves</p>	84 37xx 05424	Black	365
	<p>Bottle holder in black metal, for 3 bottles, with inlay in same material as shelves</p>	84 37xx 05423	Black	378
	<p>Bottle holder in black or white metal, for 6 bottles, with inlay in same material as shelves</p>	84 37xx 05425	Black	389

Illustration	Article number	Pcs	Price / piece Horreds NCS / black gables	Price / piece optional NCS / black gables	Price / piece veneer / black gables
--------------	----------------	-----	--	---	---

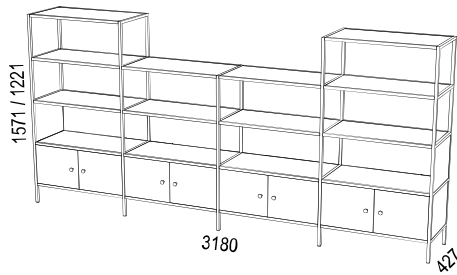
Parant

Parant COMBINATIONS



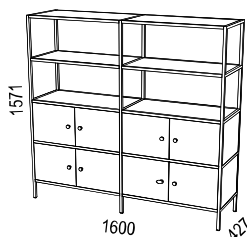
- Parant is a buildable shelf series with black metal gables in several heights. Wooden parts in veneered or lacquered design.
- Gables: RAL9005 structure, with couplings in black plastic.
- Veneer: Oak nature, ash nature, ash white pigmented, ash stained (black, dark, Burgundy, Conifer and Smokey Blue stain),
- Horreds NCS colours: see page 165
- Measurement basic unit: B810xH350XD427mm.
- Measurement sideways add-on module: B790xH350XD427mm.
- Add-on plant pot: height 175mm.
- Distance from floor to lowest shelf: 150mm.
- Contact us for a quote if you want a combination that is not illustrated below.
- For more information; see www.horreds.se

Combination A.



Gable 1571x427	34	37	040-A	2	247	247	247
Middle gable 1571x427	34	37	140-B	2	253	253	253
Middle gable 1221x427	34	37	130-A	1	216	216	216
Shelf	34	37xx	09207	14	118	135	152
Back cover	34	37xx	09212	4	94	110	118
Side cover	34	37xx	09331	2	61	75	79
Door module, start	34	37xx	37002	1	537	679	849
Door module, middle	34	37xx	37003	2	537	679	849
Door module, , finish	34	37xx	37004	1	537	679	849
Total price combination A:					5518	6411	7375

Combination B.



Gable 1571x427	34	37	040-A	2	247	247	247
Middle gable 1571x427	34	37	140-A	1	253	253	253
Shelf	34	37xx	09207	6	118	135	152
Door module, start	34	37xx	37002	2	537	679	849
Door module, finish	34	37xx	37004	2	537	679	849
Total price combination B:					3605	4271	5058

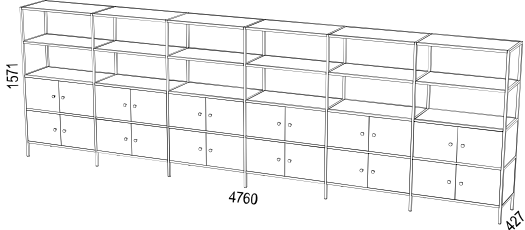
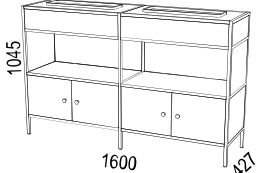
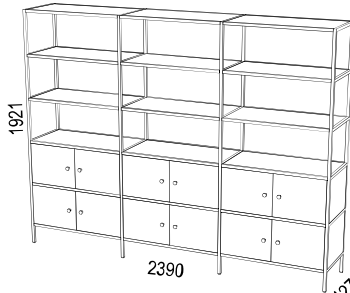
Illustration	Article number	Pcs	Price / piece Horreds NCS / black gables	Price / piece optional NCS / black gables	Price / piece veneer / black gables
Combination C.					
					
Gable 1571x427	34 37 040-A	2	247	247	247
Middle gable 1571x427	34 37 140-A	5	253	253	253
Shelf	34 37xx 09207	18	118	135	152
Door module, start	34 37xx 37002	2	537	679	849
Door module, middle	34 37xx 37003	8	537	679	849
Door module, finish	34 37xx 37004	2	537	679	849
Total price comb. C:			11094	12332	14693
Combination D.					
					
Gable 1046x427	34 37 025-A	2	206	206	206
Middle gable 10461x427	34 37 125-A	1	213	213	213
Shelf	34 37xx 09207	4	118	135	152
Door module, start	34 37xx 37002	1	537	679	849
Door module, finish	34 37xx 37004	1	537	537	849
Pot plant add-on	34 37xx 09222-2	2	321	356	413
Back cover	34 37xx 09212	2	94	110	118
Side cover	34 37xx 09331	2	61	75	79
Total price comb. D:			3125	3607	4155
Combination E.					
					
Gable 1921x427	34 37 050-A	2	282	282	282
Middle Gable 1921x427	34 37 150-A	2	288	288	288
Shelf	34 37xx 09207	12	118	135	152
Door module, start	34 37xx 37002	2	537	679	849
Door module, middle	34 37xx 37003	2	537	679	849
Door module, finish	34 37xx 37004	2	537	679	849
Total price comb. E:			5783	6833	8066

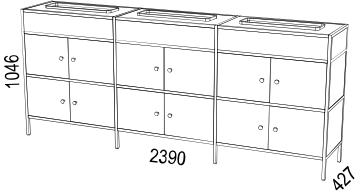
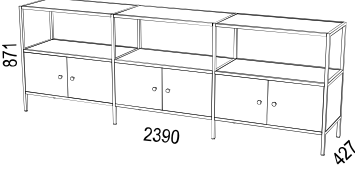
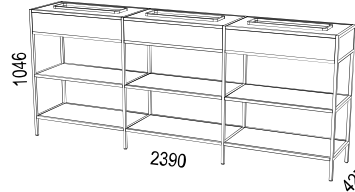
Illustration	Article number	Pcs	Price / piece Horreds NCS / black gables	Price / piece optional NCS / black gables	Price / piece veneer / black gables
Kombination F.					
					
Gable 1046x427	34 37 025-A	2	206	206	206
Middle gable 1046x427	34 37 125-A	2	213	213	213
Shelf	34 37xx 09207	3	118	135	152
Door module, start	34 37xx 37002	2	537	679	849
Door module, middle	34 37xx 37003	2	537	679	849
Door module, finish	34 37xx 37004	2	537	679	849
Flower pot add-on	34 37xx 09222-2	2	321	356	413
Flower pot add-on, middle	34 37xx 09222-3	1	321	356	413
Total price comb. F:			<u>5377</u>	<u>6385</u>	<u>7627</u>
Combinatio G.					
					
Gable 871x427	34 37 020-A	2	174	174	174
Gable middle 871x427	34 37 120-A	2	181	181	181
Shelf	34 37xx 09207	6	118	135	152
Door module, start	34 37xx 37002	1	537	679	849
Door module, middle	34 37xx 37003	1	537	679	849
Door module, finish	34 37xx 37004	1	537	679	849
Total price comb. G:			<u>3032</u>	<u>3558</u>	<u>4171</u>
Combinatio H.					
					
Gable 1046x427	34 37 025-A	2	206	206	206
Gable middle 1046x427	34 37 125-A	2	213	213	213
Shelf	34 37xx 09207	9	118	135	152
Flower pot add-on	34 37xx 09222-2	2	321	356	413
Flower pot add-on, middle	34 37xx 09222-3	1	321	356	413
Total price comb. H:			<u>2868</u>	<u>3123</u>	<u>3450</u>

Illustration	Article number	Pcs	Price / piece Horreds NCS / black gables	Price / piece optional NCS / black gables	Price / piece vener / black gables
Combination I.					
Gable 871x427	34 37 020-A	1	174	174	174
Gable middle 1221x427	34 37 130-B	1	216	216	216
Gable middle 1571x427	34 37 140-B	1	253	253	253
Gable 1571x427	34 37 040-A	1	247	247	247
Shelf	34 37xx 09207	6	118	135	152
Door module, start	34 37xx 37002	2	537	679	849
Door module, middle	34 37xx 37003	2	537	679	849
Door module, finish	34 37xx 37004	2	537	679	849
Total price combination I:			4820	5774	6896



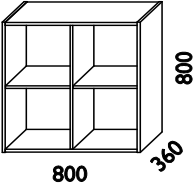
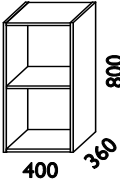
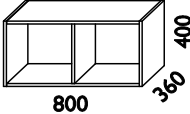
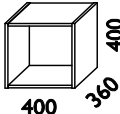
Illustration	Description	Article number	Material	EUR
	<p>ANNE Design: Anne Krook.</p> <ul style="list-style-type: none"> • White NCS 0500-N. • Veneer: Oak (03), Birch (05) and Ash (06). • Backs in HDF (white to white units and wood pattern to units in birch and oak). • Doors attach only to outer side of units. • Drawers can only be assembled into deep units. • Doors and drawers are assembled before delivery; therefore always enclose a drawing of your Anne combination. • Remote control works through glass doors only (not wooden doors). • Doors with soft-closing hinges. • Drawers with self-closing function. • For more information, see www.horreds.se 		 MÖBELFAKTA	
Anne DEEP BASIC UNITS				
	<p>Deep basic unit with stationary divider and adjustable shelves.</p> <p>Deep basic unit with stationary divider, without shelves.</p>	<p>16 xx 009D 16 31 009D</p> <p>16 xx 009DU 16 31 009DU</p>	<p>Oak/Birch White</p> <p>Oak/Birch White</p>	<p>621 597</p> <p>595 572</p>
	<p>Deep basic unit with adjustable shelf.</p> <p>Deep basic unit without shelf.</p> <p>Deep basic unit with adjustable shelf, without back.</p>	<p>16 xx 011D 16 31 011D</p> <p>16 xx 011DU 16 31 011DU</p> <p>16 xx 011DO 16 31 011DO</p>	<p>Oak/Birch White</p> <p>Oak/Birch White</p> <p>Oak/Birch White</p>	<p>380 365</p> <p>354 340</p> <p>348 334</p>
	<p>Deep basic unit with stationary divider.</p> <p>Deep basic unit without divider.</p> <p>Deep basic unit with stationary divider, without back.</p> <p>Deep basic unit without divider, without back.</p>	<p>16 xx 012D 16 31 012D</p> <p>16 xx 012DU 16 31 012DU</p> <p>16 xx 012DO 16 31 012DO</p> <p>16 xx 012DUO 16 xx 012DUO</p>	<p>Oak/Birch White</p> <p>Oak/Birch White</p> <p>Oak/Birch White</p> <p>Ek/Björk Vit</p>	<p>380 365</p> <p>354 340</p> <p>348 334</p> <p>321 308</p>
	<p>Deep basic unit.</p> <p>Deep basic unit without back</p>	<p>16 xx 013D 16 31 013D</p> <p>16 xx 013DO 16 31 013DO</p>	<p>Oak/Birch White</p> <p>Oak/Birch White</p>	<p>251 241</p> <p>223 214</p>

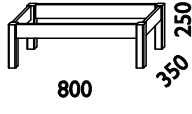
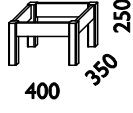
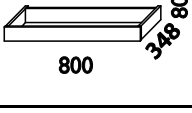
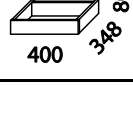
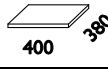
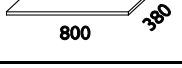
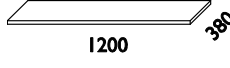
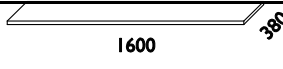
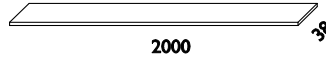
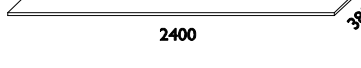
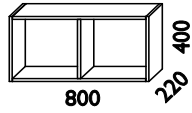
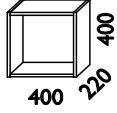
Illustration	Description	Article number	Material	EUR
Anne BASES				
	Deep leg base, wood, 800 mm	16 xx 017D 16 31 017D	Oak/Birch White	242 242
	Deep leg base, wood, 400 mm	16 xx 018D 16 31 018D	Oak/Birch White	211 211
	Deep base, wood, 800 mm	16 xx 007D 16 31 007D	Oak/Birch White	114 114
	Deep base, wood, 400 mm	16 xx 008D 16 31 008D	Oak/Birch White	92 92
	800 mm 400 mm	16 00 045 16 00 046		49 39
Anne TOP SHELVES.				
• Depth 380 mm. 23 mm thick. • Only suitable to deep basic units (not for shallow units or TV-cabinets).				
	Length 400 mm	16 xx 201 16 31 201	Oak/Birch White	176 176
	Length 800 mm	16 xx 202 16 31 202	Oak/Birch White	204 204
	Length 1200 mm	16 xx 203 16 31 203	Oak/Birch White	238 238
	Length 1600 mm	16 xx 204 16 31 204	Oak/Birch White	299 299
	Length 2000 mm	16 xx 206 16 31 206	Oak/Birch White	346 346
	Length 2400 mm	16 xx 207 16 31 207	Oak/Birch White	389 389
Anne SHALLOW BASIC UNITS FOR WALL				
	Shallow basic unit with stationary divider.	16 xx 012G 16 31 012G	Oak/Birch White	370 355
	Shallow basic unit without divider.	16 xx 012GU 16 31 012GU	Oak/Birch White	343 330
	Wallhanging kit in MDF. 800 mm.	16 00 045		49
	Shallow basic unit.	16 xx 013G 16 31 013G	Oak/Birch White	232 223
	Wallhanging kit in MDF. 400 mm.	16 00 046		39

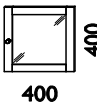
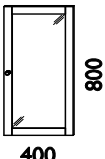
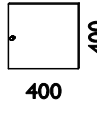
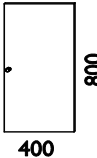
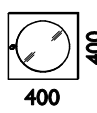
Illustration	Description	Article number	Material	EUR
Anne DOORS				
		Närmaste NCS:		
		White NCS 0500-N		
		Grey green NCS S2502G		
		Yellow NCS S1050-Y10R		
	Glass door Anne	16 xx 031	Oak/Birch	188
	Glass door Anne, with frosted glass	16 31 031	White	188
		16 xx 031A	Oak/Birch	211
		16 31 031A	White	211
	Glass door Anne	16 xx 032	Oak/Birch	246
	Glass door Anne, with frosted glass	16 31 032	White	246
		16 xx 032A	Oak/Birch	269
		16 31 032A	White	269
	Door Anne	16 xx 021	Oak/Birch	107
		16 31 021	White	107
		16 48 021	Grey-green	107
		16 49 021	Yellow	107
	Door Anne	16 xx 022	Oak/Birch	193
		16 31 022	White	193
		16 48 022	Grey-green	193
		16 49 022	Yellow	193
	Glass door Anne, with round glass	16 xx 034	Oak/Birch	143
		16 31 034	White	143
		16 48 034	Grey-green	143
		16 49 034	Yellow	143
	Glass door Anne, with round frosted glass	16 xx 034A	Oak/Birch	166
		16 31 034A	White	166
		16 48 034A	Grey-green	166
		16 49 034A	Yellow	166

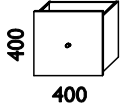
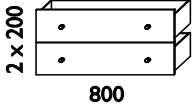
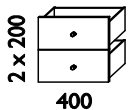


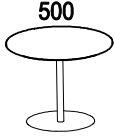
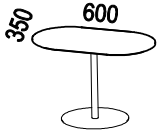
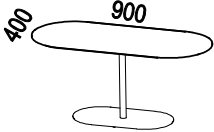
Illustration	Description	Article number	Material	EUR
Anne DRAWERS				
<ul style="list-style-type: none"> • With soft- and self-closing funktion. • Incl standard handle in brushed steel • Fits only in deep basic units 				
	Drawer Anne	16 xx 039 16 31 039 16 48 039 16 49 039	Oak/Birch White Grey-green Yellow	229 229 229 229
	Pair of drawers Anne. Only for basic unit 12DU.	16 xx 040 16 31 040 16 48 040 16 49 040	Oak/Birch White Grey-green Yellow	515 515 515 515
	Pair of drawers Anne.	16 xx 041 16 31 041 16 48 041 16 49 041	Oak/Birch White Grey-green Yellow	363 363 363 363
Anne ACCESSORIES				
	Wine rack for 9D	16 31 042A 16 48 042A 16 49 042A	White Grey-green Yellow	143 143 143
	Wine rack for 11D + 12D	16 31 042B 16 48 042B 16 49 042B	White Grey-green Yellow	143 143 143
	Wine rack for 13D	16 31 042C 16 48 042C 16 49 042C	White Grey-green Yellow	143 143 143
	Deep extra shelf for 9D/9DU+12D. Width 37,5 cm.	16 xx 044 16 31 044	Oak/Birch White	57 57
	Deep extra shelf for 11D/11DU+13D With 36,7 cm.	16 xx 044B 16 31 044B	Oak/Birch White	57 57
	Shallow extra shelf for 12G Width 37,5 cm.	16 xx 047 16 31 047	Oak/Birch White	50 50
	Shallow extra shelf for 13G With 36,7 cm.	16 xx 047B 16 31 047B	Oak/Birch White	50 50
	Deep extra shelf for 12DU Width 76,8 cm.	16 xx 050 16 31 050	Oak/Birch White	128 128
	Deep glass shelf for 9D/9DU + 12D	16 00 048	Glass	43
	Deep glass shelf for 11D/11DU + 13D	16 00 048B	Glass	43
	Shallow glass shelf for 9G/9GU + 12G	16 00 049	Glass	38
	Shallow glass shelf for 11G/11GU + 13G	16 00 049B	Glass	38
	Mounted lock in door	16 00 058	Förnicklät	142

Illustration	Description	Article number	Material	EUR
 <p>LAP Design: Fredrik Mattson</p> <ul style="list-style-type: none"> • Table top in 14 mm white compact laminate with black core and chamfered edge alternatively 19 mm veneered MDF 19. • Column leg in white powder coated steel (RAL 9016) • Available in 3 heights. Illustrations below show table in height 430 mm • To round top and to oval top in size 600x350 the column base is round • To oval top in size 900x400 the column base is oval <p><u>Veneer group 1:</u> Oak (03), Ash (06), Birch (05), Beech (04) <u>Veneer group 2:</u> Black stained Ash (86), Dark stained Ash (76), White pigmented Oak (30), White pigmented Ash (10)</p> <p><u>Heights:</u> 430 mm (1), 530 mm (2), 630 mm (3)</p>				
 <p>500</p>	Round table top, diameter 500 mm, including column leg with round base Height; 430, 530 or 630 mm.	55 xx xx 03802-x 55 xx xx 03802-x 55 31 xx 03802-x	Veneer gr 1 Veneer gr 2 White comp.lam.	458 458 519
 <p>350 600</p>	Oval table top, 600x350 mm, including column leg with round base Height; 430, 530 or 630 mm.	55 xx xx 03803-x 55 xx xx 03803-x 55 31 xx 03803-x	Veneer gr 1 Veneer gr 2 White comp.lam.	476 476 543
 <p>400 900</p>	Oval table top, 900x400 mm, including column leg with oval base Height; 430, 530 or 630 mm.	55 xx xx 03804-x 55 xx xx 03804-x 55 31 xx 03804-x	Veneer gr 1 Veneer gr 2 White comp.lam.	507 507 579

SALES TERMS

All previous price lists are no longer valid. All prices are quoted in Euro excl. VAT. Our digital price list is regularly updated and products may be added or discontinued. Price adjustments may occur. For the latest issue, see www.horreds.se

TERMS OF PAYMENT

30 days net or according to agreement.

When payment falls due, we reserve the right charge 2% interest/month. Payment by cheque is not accepted. Only International bank transfers are accepted. Bank details according to the invoice.

TERMS OF DELIVERY

Deliveries will only be effected at our terms of payment and delivery. The goods remain the property of Horreds Möbel AB until full payment has been settled. Dispatch date is when goods are leaving factory. Standard package is included, pallets and wooden crates are charged separately. Tail gates, fixed delivery date and telephone notification will be charged separately. Quotations submitted by Horreds are, unless otherwise stated, valid for 30 days from the quotation date. For deliveries well ahead of time, e.g. 6 months from the quotation date, this must be agreed on each individual occasion.

FREIGHT CHARGES

Europe 1

Finland, Latvia, Lithuania, Estonia, Germany, Benelux.

Free delivery DAP on order above 2500 Euro net. For orders less than 2500 Euro, a freight cost of 225 Euro is charged.

Europe 2

Austria, United Kingdom, Poland, Czech Republic, Slovakia, Hungary.

Free delivery DAP on order above 2500 Euro net. For orders less than 2500 Euro, a freight cost of 350 Euro is charged.

Other countries

Ex Works or according to agreement. (documents sent by courier will be charged)

CLAIMS AND TRANSPORT DAMAGES

Any claims or transport damages must be reported to Horreds. A special claim report shall be sent in together with photos to export@horreds.se. Visible damages must also be notified on the waybill when receiving the goods. Invisible damages must be reported within 6 days. Photos must be taken on all damages for us to be able to handle the claim.

GUARANTEE

Office furniture according to Price list 1: 10 years for wood and metal parts with the exception of electric legs having 5 years and clothing material for table screens and insert materials which have 1 year.

Meeting places/Environmental furniture according to Price list 2: 5 years with the exception of clothing material and input material which have 1 year.

Input material such as locks, hinges, electrical parts, expanders and lamps: 1 year.


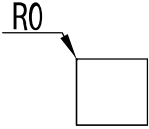
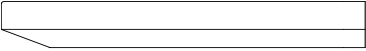
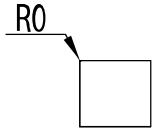

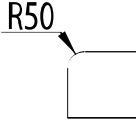

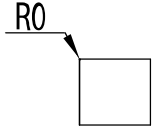
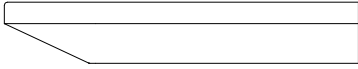
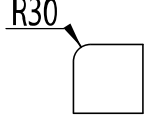

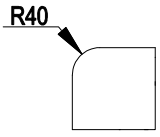

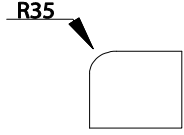

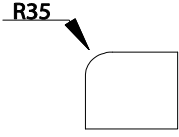
Customized products: 1 year.

The guarantees are valid from the date of the original invoice against production errors at normal use of the product. We reserve the right to make changes in construction and design without notice.

FORCE MAJEURE

Horreds shall not be liable for any loss, damage, delay, changes in shipment schedules or failure to deliver caused by accidents, fire, strikes, riots, civil commotion, insurrection, war, the elements, embargoes, failure of carriers, inability to obtain transportation facilities, government requirements, acts of God or public enemy, prior orders from customers or limitations on the company's or its supplier's production or marketing activities or any other causes or contingencies beyond the company's control.

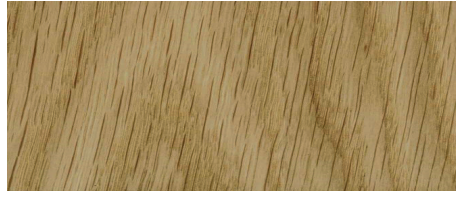
SHOWROOMS: Horreds Möbel AB (Head Office), Varbergsvägen 448, HORRED. Tel +46 320 184 00
R40, Rosenlundsgatan 40, STOCKHOLM. Tel +46 73 828 00 15
Studio L6, Lasarettsgatan 6, GÖTEBORG. Tel +46 70 241 99 69
Horreds Möbel AB, Slussgatan 10, 211 30 MALMÖ. Tel +46 70 241 99 69
Skoyen Design Center, Drammensveien 130C1, OSLO. Tel +47 90 02 89 98
Norliitt Design, Store Kognensgade 81, COPENHAGEN. Tel +45 23 62 42 42

	<u>Profil / profile:</u>	<u>Radie / radius :</u>
<p><u>VX (3416)</u> Rak matchande kantlist i plast alternativt faner. Hörradie 0. <i>Straight edge, matching edging. Corner radius 0.</i></p>		<p>R0</p> 
<p><u>VX (3417)</u> Fasad kant med rak matchande kantlist i plast alternativt faner. Hörradie 0. <i>Chamfered edge with straight matching edging.</i> Corner radius 0.</p>		<p>R0</p> 
<p><u>VX R50 (3418)</u> Rak matchande kantlist i plast alternativt faner. Hörradie 50. <i>Straight edge, matching edging. Corner radius 50.</i></p>		<p>R50</p> 
<p><u>A-Frame (6416) / Nomono (53) / Tin (47)</u> Rak, matchande kantlist i plast alternativt faner. Hörradie 0. <i>Straight edge, matching edging. Corner radius 0.</i></p>		<p>R0</p> 
<p><u>Fri (3517)</u> Fasad MDF-kant. Klarlackad kant till ask, björk, ek, laminat och desktop. Matchande till betsade och vitpigmenterade bord. Hörradie 30. <i>Chamfered MDF edge. Clear coated edge on ash, birch, oak, laminate and linoleum. Matching colour to stained and white pigmented tables.</i> Corner radius 30.</p>		<p>R30</p> 
<p><u>Henry (80)</u> Rak, vit plastkantlist. Hörradie 40. <i>Straight edge, white edging. Corner radius 40.</i></p>		<p>R40</p> 
<p><u>Siglo (6016)</u> Matchande kantlist i plast till laminat och desktop. Vit kantlist i plast till fanerade bord. Hörradie 35. <i>Matching edging to laminate and linoleum. White edging to veneered desks. Corner radius 35.</i></p>		<p>R35</p> 
<p><u>Siglo (6020)</u> Falsad kant med matchande kantlist i plast till laminat och desktop. Vit kantlist i plast till fanerade bord. Hörradie 35. <i>Chamfered with matching edging to laminate and linoleum.</i> White edging to veneered desks. Corner radius 35.</p>		<p>R35</p> 

BORDSSKIVOR FANER / TABLE TOPS VENEER



06 Ask / Ash



03 Ek / Oak



05 Björk / Birch



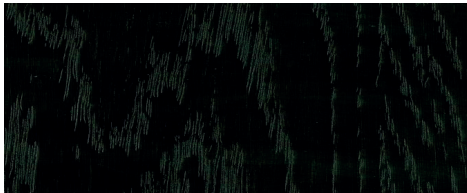
10 Vit ask / White ash



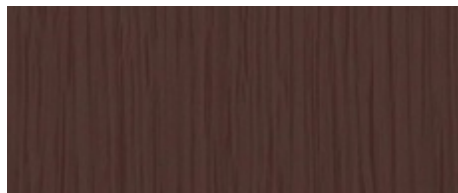
30 Vit ek / White oak



76 Mörk ask / Dark ash



86 Svart ask / Black ash



C8 Burgundy



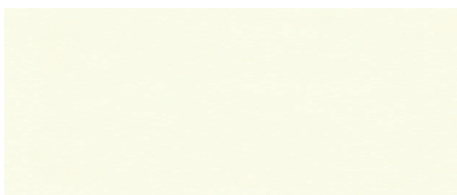
D3 Conifer



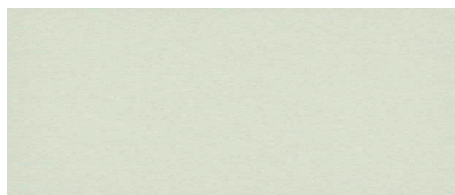
D4 Smokey Blue

Tänk på: I trä som är en naturprodukt kan mindre avvikelser i bets och struktur förekomma /
Note: In wood, that is a natural product, minor deviations in stain and structure can occur

BORDSSKIVOR LAMINAT / TABLE TOPS HPL



Vit 0754 (standardlaminat)
närmaste NCS S0502-Y



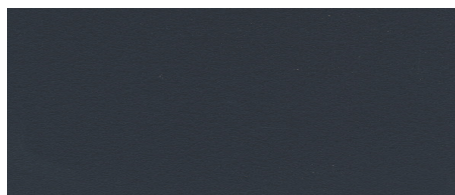
Ljusgrå 0419 (tillvalslaminat)
närmaste NCS S1500-N



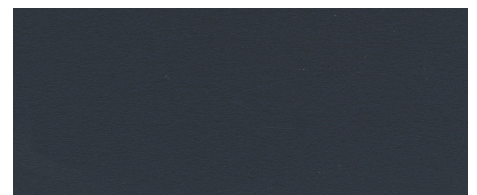
Ljusgrå 1365 (tillvalslaminat)
närmaste NCS S2005-R80B



Mellanrå 1023 (tillvalslaminat)
närmaste NCS S5500-N

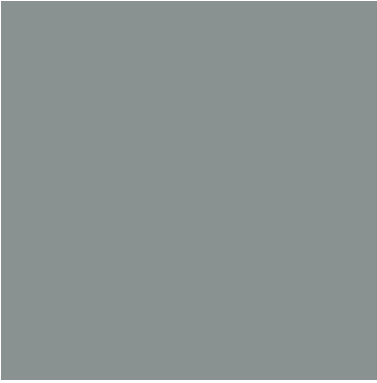


Antracit 1397 (tillvalslaminat)
närmaste NCS S7500-N

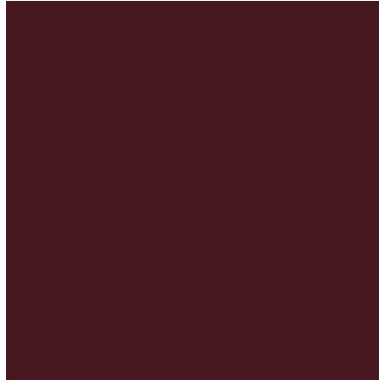


Svart 2253 (tillvalslaminat)
närmaste NCS S9000-N

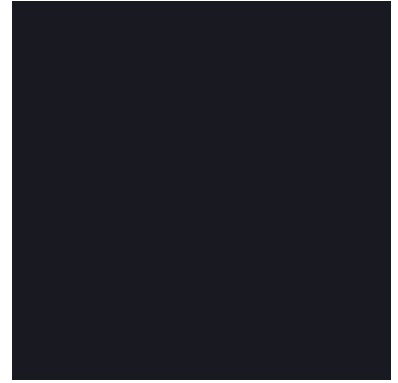
BORDSSKIVOR DESKTOP / TABLE TOPS LINOLEUM



4132 Ash
closest NCS 5502-G



4154 Burgundy
closest NCS 7010-R10B



4166 Charcoal
closest NCS 8502-B



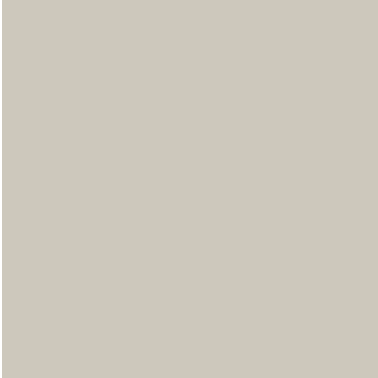
4172 Mauve
closest NCS 7005-Y80R



4174 Conifer
closest NCS 8010-B90G



4175 Pebble
closest NCS 3502-Y



4176 Mushroom
closest NCS 2002-Y



4177 Vapour
closest NCS 2005-G10Y



4179 Smokey Blue
closest NCS 7010-R90B



4184 Olive
closest NCS 5010-G50Y

Färgavvikelser kan förekomma av trycktekniska skäl

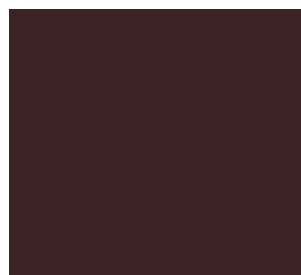
RAL-KULÖRER METALL / RAL COLOURS METAL



1019 Grey beige (3H)
Tillval utvalda produkter
Optional selected products



1024 Ochre yellow (3G)
Tillval utvalda produkter
Optional selected products



3007 Black red (3D)
Tillval utvalda produkter
Optional selected products



5008 Grey blue (3C)
Tillval utvalda produkter
Optional selected products



6009 Fir green (3L)
Tillval utvalda produkter
Optional selected products



6013 Reed green (3K)
Tillval utvalda produkter
Optional selected products



7039 Quartz grey (3J)
Tillval utvalda produkter
Optional selected products



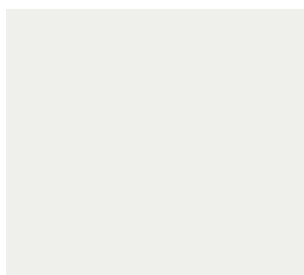
7044 Silk grey (3A)
Tillval utvalda produkter
Optional selected products



9005 Jet black (37)
Standard



9006 White alu. (38)
Standard utvalda produkter
Standard selected products



9016 Traffic white (31)
Standard/tillval utvalda produkter
Standard/optional selected prod.

Slät lack med glans 30. Vissa produkter finns endast i standardkulör med strukturlack.

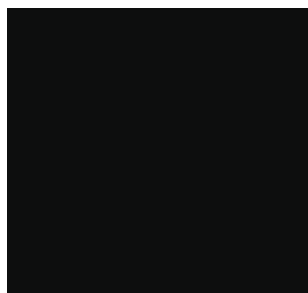
Smooth varnish, gloss 30. Some products are only available in standard colour with textured paint.

Färgavvikelser kan förekomma av trycktekniska skäl
Colour deviations may occur for printing technical reasons.

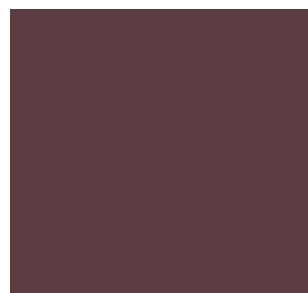
TILLVALSKULÖRER NCS / SELECTED COLOURS NCS



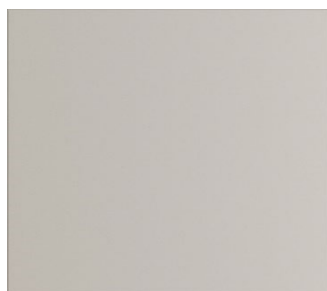
BE Beige
S3005-Y20R



BK Black
S 9000-N



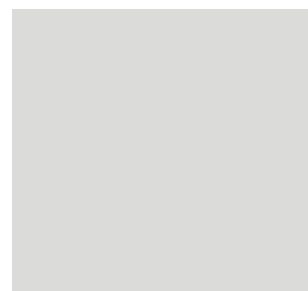
BY Burgundy
S 7010-R10B



GG Greige
2903-Y30R



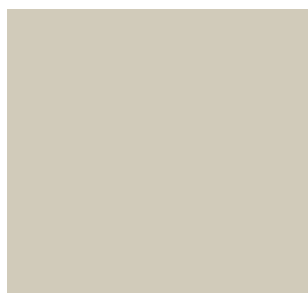
GP Graphite
S 7500-N



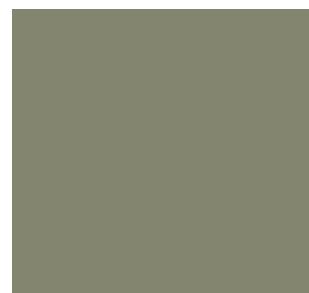
GW Greywhite
S 1500-N



LG Lightgrey
S 3000-N



LI Linen
S 2005-Y20R



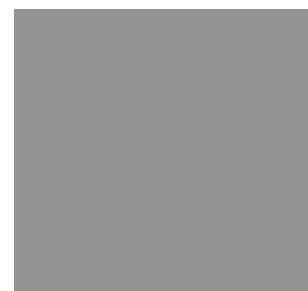
OL Olive
S 5010-G70Y



SB Soft beige
S 2010-Y30R



SD Sand
S 4005-Y50R



SG Steel grey
S 4500-N



WW Warm white
1204-Y26R

Färgavvikelse kan förekomma av trycktekniska skäl
Colour deviations may occur for printing technical reasons.

NOMONO HANDTAG



Svart, black
närmaste NCS S9000-N



Gul, yellow
närmaste NCS S1070-Y



Grön, green
närmaste NCS S2570-G30Y



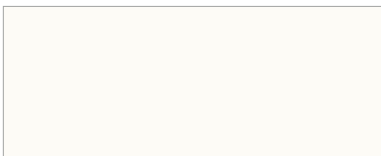
Röd, red
närmaste NCS S1580-Y80R



Turkosblå, turquoise
närmaste NCS S0540-B30G



Orange, orange
närmaste NCS S1080-Y50R



Vit, white
närmaste NCS S0300-N

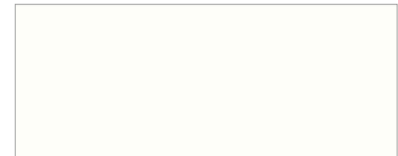
ANNE-HYLLAN



Björkfaner, birch veneer



Ekfaner, oak veneer



Vit, white
närmaste NCS S0500-N



Grågrön, grey-green
närmaste NCS S2502-G



Gul, yellow
närmaste NCS S1050-Y10R

Price groups fabrics

Below you will find a list of standard fabrics for our seating furniture.

The list shows the difference price groups and which products it is suitable for.

For price information for fabrics not listed below; please send us a price inquiry.

Several of our products can be produced with multiple fabrics; please send us a price inquiry.

Producer:	Fabric:	Price group:	Base / Cuba	Glove	VX barpall	Mute / LOG	Grand / Prime
Camira	Main Line Flax	PG1	•	•	•	•	•
Camira	Main Line Twist	PG1	•	•	•	•	•
Gabriel	Cura	PG1	•	•	•	•	•
Gabriel	Focus	PG1	•	•	•	•	•
Gabriel	Focus Melange	PG1	•	•	•	•	•
Gabriel	Go Uni	PG1	•	•	•	•	•
Gabriel	Medley	PG1	•	•	•	•	•
Gabriel	Step	PG1	•	•	•	•	•
Kvadrat	Autumn	PG1	•	•	•	•	•
Kvadrat	Guest	PG1	•	•	•	•	•
Kvadrat	Reflect	PG1	•	•	•	•	•
Kvadrat	Relate	PG1	•	•	•	•	•
Vescom	Colour Connect	PG1	•	•	•	•	•
Camira	Blazer	PG2	•	•	•	•	•
Camira	Monochrome sett	PG2	•	•	•	•	•
Gabriel	Go Check	PG2	•	•	•	•	•
Gabriel	Parcel Loop	PG2	•	•	•	•	•
Gabriel	Step Melange	PG2	•	•	•	•	•
Gabriel	Tempt	PG2	•	•	•	•	•
Kvadrat	Remix	PG2	•	•	•	•	•
Nevotex	Grace	PG2	•	•	•	•	•
Nevotex	Lido	PG2	•	•	•	•	•
Nevotex	Lido Trend	PG2	•	•	•	•	•
Nevotex	Pod	PG2			•	•	•
Nevotex	Sealife	PG2	•	•	•	•	•
Nevotex	Stella	PG2	•	•	•	•	•
Svensson	Ally	PG2	•	•	•	•	•
Svensson	Easy	PG2	•	•	•	•	•
Vescom	Avon	PG2	•	•	•	•	•
Vescom	Arches	PG2	•	•		•	•
Vescom	Arrow	PG2	•	•		•	•
Vescom	Creek	PG2	•	•		•	•
Vescom	Cyprus	PG2	•	•		•	•
Vescom	Dalma	PG2	•	•		•	•
Vescom	Furka Plus	PG2	•	•		•	•
Vescom	Jemo	PG2	•	•		•	•
Vescom	Leone Plus	PG2	•	•		•	•
Vescom	Malta	PG2	•	•		•	•

Vescom	Samar	PG2	•	•	•	•	•
Vescom	Scott	PG2	•	•	•	•	•
Vescom	Zenith	PG2	•	•	•	•	•
Camira	Synergy	PG3	•	•	•	•	•
Camira	Yoredale	PG3	•	•	•	•	•
Gabriel	Amaze Loop	PG3	•	•	•	•	•
Gabriel	Breeze Fusion	PG3	•	•	•	•	•
Gabriel	Capture	PG3	•	•	•	•	•
Gabriel	Crisp	PG3	•	•	•	•	•
Gabriel	Fame	PG3	•	•	•	•	•
Gabriel	Grain	PG3	•	•	•	•	•
Gabriel	Morph	PG3	•	•	•	•	•
Gabriel	Renewed Loop	PG3	•	•	•	•	•
Gabriel	Select	PG3	•	•	•	•	•
Kvadrat	Ame	PG3	•	•	•	•	•
Kvadrat	Atlas	PG3	•	•	•	•	•
Kvadrat	Sport	PG3	•	•	•	•	•
Nevotex	Imola Plus	PG3	•	•	•	•	•
Nevotex	Jazz	PG3	•	•	•	•	•
Nevotex	Wooly	PG3	•	•	•	•	•
Svensson	Harper	PG3	•	•	•	•	•
Svensson	Heritage Blend	PG3	•	•	•	•	•
Svensson	Semi	PG3	•	•	•	•	•
Svensson	Step	PG3	•	•	•	•	•
Vescom	Acton	PG3	•	•	•	•	•
Vescom	Moore	PG3	•	•	•	•	•
Vescom	Norfolk	PG3	•	•	•	•	•
Vescom	Wilson	PG3	•	•	•	•	•
Bogesunds	Liv	PG4	•	•	•	•	•
Gabriel	Focus Royal	PG4	•	•	•	•	•
Gabriel	Passion	PG4	•	•	•	•	•
Jørgenssen	Puxx 1/2	PG4	•	•	•	•	•
Kvadrat	Canvas	PG4	•	•	•	•	•
Kvadrat	Re-wool	PG4	•	•	•	•	•
Kvadrat	Steelcut	PG4	•	•	•	•	•
Kvadrat	Steelcut Trio	PG4	•	•	•	•	•
Nevotex	Blues	PG4	•	•	•	•	•
Nevotex	Funk	PG4	•	•	•	•	•
Nevotex	Pop	PG4	•	•	•	•	•
Romo	8028 Elio FR	PG4	•	•	•	•	•
Svensson	Ink	PG4	•	•	•	•	•
Svensson	Mingel	PG4	•	•	•	•	•
Vescom	Auckland	PG4	•	•	•	•	•
Vescom	Dikson	PG4	•	•	•	•	•
Vescom	Foster	PG4	•	•	•	•	•
Vescom	Fuga	PG4	•	•	•	•	•
Vescom	Hestan	PG4	•	•	•	•	•

Villa Nova	V3571 Linea	PG4	•	•	•	•	•
Gabriel	Savoy	PG5	•	•		•	•
Kirkby Design	K5186 Fibre	PG5	•	•	•	•	•
Kirkby Design	K5260 Fleck ECO	PG5	•	•	•	•	•
Kvadrat	Devina / Devina MD	PG5	•	•	•	•	•
Kvadrat	Devina Melange	PG5	•	•	•	•	•
Kvadrat	Fiord	PG5	•	•	•	•	•
Kvadrat	Hallingdal	PG5	•	•	•	•	•
Kvadrat	Hero	PG5	•	•	•	•	•
Kvadrat	Melange NAP	PG5	•	•	•	•	•
Kvadrat	Steelcut Quartet	PG5	•	•	•	•	•
Maharam	Merit	PG5	•	•	•	•	•
Maharam	Messenger	PG5	•	•	•	•	•
Nevotex	Grand Lazio Velvet	PG5	•	•	•	•	•
Nevotex	Illusion	PG5	•	•		•	•
Nevotex	Illusion Full grain	PG5	•	•		•	•
Svensson	Balance	PG5	•	•	•	•	•
Svensson	Rami	PG5	•	•	•	•	•
Vescom	Lamu	PG5	•	•	•	•	•
Vescom	Lani	PG5	•	•	•	•	•
Vescom	Wolin	PG5	•	•	•	•	•
Gabriel	Nobel	PG6	•	•	•	•	•
Kvadrat	Arda	PG6	•	•	•	•	•
Kvadrat	Mizmaze	PG6	•	•	•	•	•
Nevotex	Barnum	PG6	•	•	•	•	•
Kvadrat	Drop	PG7	•	•	•	•	•
Kvadrat	Sisu	PG7	•	•	•	•	•
Elmo Leather	Elmonordic	Läder	•	•	•	•	•
Elmo Leather	Elmosoft	Läder	•	•	•	•	•
Nevotex	Vintage	Läder	•	•	•	•	•

Rev.2025-01-01

**BE THE
REBEL
WITH A
PURPOSE.**



Horreds Möbel AB
Varbergsvägen 448, SE-519 30 Horred, SWEDEN
vx. +46 320 184 00, info@horreds.se

www.horreds.se